

BB36 LED recessed spot set, DALI dimmable, incl. connection box
 Article no. 41497183

Light.
 For Generations.

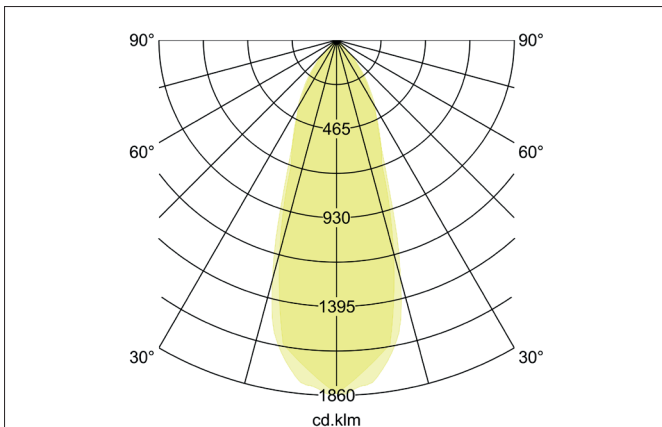
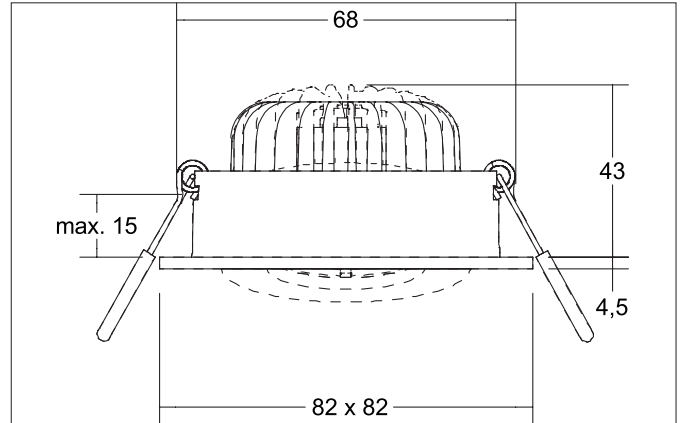

Tender
 LED recessed spot set, DALI dimmable, incl. connection box, Square. Toolless ceiling installation by installation springs. Ceiling cut-out Ø 68 mm, Installation depth 43 mm, Length 82 mm, Width 82 mm, Weight 0,312 kg, Reflector silver with rotationssymmetrical, deep, wide distributed light intensity. optimal light distribution due to a polycarbonat clear cover. Luminous flux 680 lm, Power 1 x 7 W, System Efficiency 97 lm/W, Light colour warm white, Correlated color temprature (CCT) 3.000 K, Colour rendering index CRI > 80, Rated life time L70/B50 at 25 °C: 50000 h, Housing material: Aluminium / Plastic, Colour: White structure, Permissible ambient temperature (ta): -20 °C - +25 °C, Protection class (EN 61140): II, Degree of protection (DIN EN 60529): IP20. With electronic driver, DALI-2 dimmable.

Article data	
Article no.	41497183
GTIN	4251433953180
Series name	BB36
Short description	LED recessed spot set, DALI dimmable, incl. connection box
Material	Aluminium / Plastic
Colour	White
Type of surface	Structure
Shape	Square
Built-in diameter	68 mm
Installation depth	43 mm
Length	82 mm
Width	82 mm
Hight	4.5 mm
Scope of delivery	Incl. 5-pole connection box
Weight	0.312 kg

BB36 LED recessed spot set, DALI dimmable, incl. connection box

Article no. 41497183

Light.
For Generations.

Lighting technology	
Colour temperature	3.000 K
Light colour	White
Light output	Direct
Luminous flux	680 lm
System efficiency	97 lm/W
Colour rendering	CRI > 80
Reflector	High-gloss
Reflektorfarbe	silver
Beam angle	40°
Light sharing	Symmetric

Operating technology of the luminaire	
---------------------------------------	--

Operating technology of driver	
Length	130 mm
Width	42 mm
Hight	22 mm
AC nominal voltage min	220 V
AC nominal voltage max	240 V
Control	DALI-2
Starting current	1A
Power min	2.8 W
Power	7 W
Current	350 mA
Degree of protection	IP20
Protection class	II
Flickerfrei	Yes

Mounting technology	
Mounting method	Recessed mounting
Place of installation	Ceiling-mounted
Adjustability	Pivoted
Swivel angle	20°
Max. ceiling thickness	15 mm
Further references	No cover with thermal insulation material
Material cover	Polycarbonat clear
Suitable for through-wiring	Yes

Packing data	
Gross weight	0.395 kg
Length of packaging	140 mm
Packaging width	110 mm
Packaging hight	120 mm
Disposal at end of life	This product must not be disposed of with household waste. You are obliged, to dispose of such electrical waste separately. By disposing of electrical waste and other old or defective electronics separately, you support recycling or other forms of re-use. In that way you help to take care and to avoid that harmful substances get into the environment.