



### Safety Instructions

1, 2, 3, 4, 5, 6, 7, 8, 12, 15,  
16, 17, 18, 19, 20, 24, 28,  
33, 34



### Info

[www.paulmann.com](http://www.paulmann.com)

Paulmann Licht GmbH  
Quezinger Feld 2  
31832 Springe  
Germany

[www.paulmann.com](http://www.paulmann.com)

Art.-Nr: 706.41/42/43/44/45  
/46/47/48/49/50/51  
/52/53/54/55/56

(+MA326 ) PYG 07/18



706.41\_42\_43  
706.53\_54\_55\_56



1x



1x

706.44\_45\_46\_47\_48  
706.49\_50\_51\_52



1x

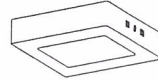

1x



Incl.

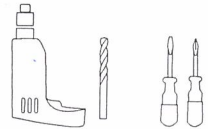

**A**

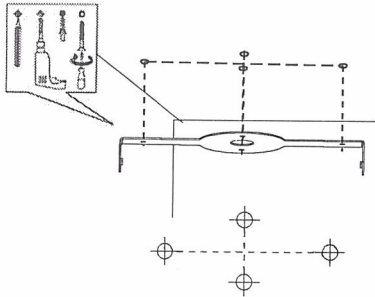

70641/42/43/44/45/46/48/49/50/51/53/54

**Safety Instructions**  
Nr.3,4,5,6,7,8 off

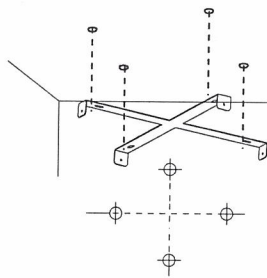

70647/51/52/56

**B**

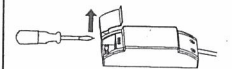

**C**

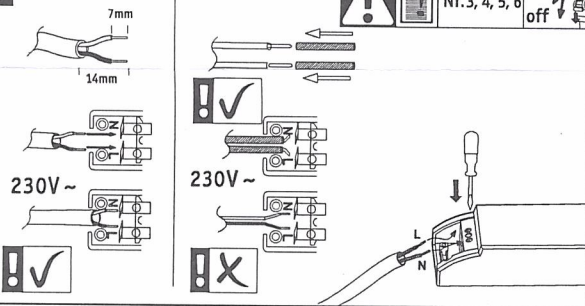

**D**

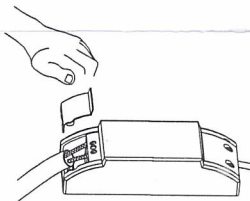

**E**

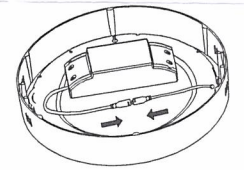

**Safety Instructions**  
Nr.3, 4, 5, 6 off

**F**

**Safety Instructions**  
Nr.3, 4, 5, 6 off

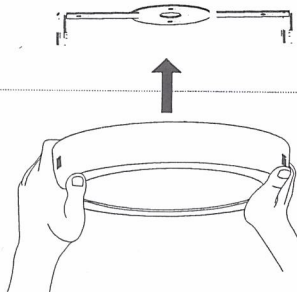

**G**

**Safety Instructions**  
Nr.3, 4, 5, 6 off



**H**

**Safety Instructions**  
on

