

zafferano

LAMPES A PORTER

ISTRUZIONI D'USO | INSTRUCTIONS FOR USE | GEBRAUCHSANWEISUNG
| MODE D'EMPLOI | INSTRUCCIONES DE USO

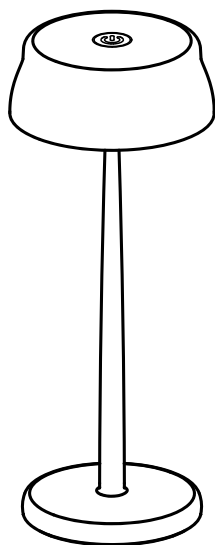

sister light

Design Federico de Majo

Lampada da tavolo ricaricabile | Rechargeable table lamp | Aufladbare Tischlamp
| Lampe de table rechargeable | Lámpara de mesa recargable





LAMPES A PORTER

indice | index | índice



IT

| | |
|--|---|
| SISTER LIGHT LAMPADA DA TAVOLO RICARICABILE | 1 |
| ISTRUZIONI D'USO | 2 |
| CONFIGURAZIONE MENU | 3 |
| RESET DELLE IMPOSTAZIONI | 4 |
| ISTRUZIONI DI MONTAGGIO | 4 |



EN

| | |
|---|---|
| SISTER LIGHT RECHARGEABLE TABLE LAMP | 5 |
| INSTRUCTIONS FOR USE | 6 |
| CONFIGURATION MENU | 7 |
| RESETTING THE SETTINGS | 8 |
| ASSEMBLY INSTRUCTIONS | 8 |



DE

| | |
|--|----|
| SISTER LIGHT AUFLADBARE TISCHLAMP | 9 |
| GEBRAUCHSANWEISUNG | 10 |
| MENÜ-KONFIGURATION | 11 |
| RESET DER EINSTELLUNGEN | 12 |
| MONTAGEANLEITUNG | 12 |



FR

| | |
|---|----|
| SISTER LIGHT LAMPE DE TABLE RECHARGEABLE | 13 |
| MODE D'EMPLOI | 14 |
| CONFIGURATION MENU | 15 |
| RÉINSTALLATION DES PARAMÈTRES | 16 |
| NOTICE DE MONTAGE | 16 |



ES

| | |
|--|----|
| SISTER LIGHT LÁMPARA DE MESA RECARGABLE | 17 |
| INSTRUCCIONES DE USO | 18 |
| CONFIGURACIÓN MENÚ | 19 |
| RESTABLECIMIENTO DE LAS CONFIGURACIONES | 20 |
| INSTRUCCIONES DE MONTAJE | 20 |

sister light

Lampada da tavolo ricaricabile

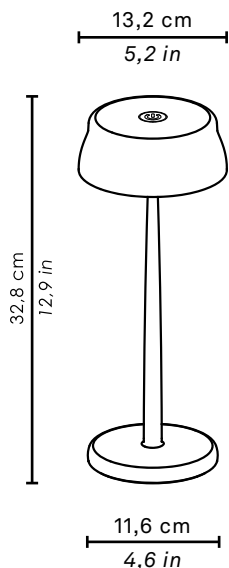

LED NON SOSTITUIBILE

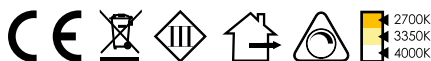

LED DIMMER

3W • 250lm - 260lm - 270lm • 2700K
- 3350K - 4000K • IP65 • 220-240V
50-60Hz • CRI>90 • 5Vdc max 2A
Ø 13,2 x h 32,8 x Ø 11,6 cm
Ø 5,2 x h 12,9 x Ø 4,6 in

LD0300A3 alluminio anodizzato
LD0300O3 oro anodizzato
LD0300R3 rame anodizzato
LD0300B3 blu anodizzato
LD0300V3 verde anodizzato

* per le istruzioni di montaggio visitare il sito web

Inclusi

 Cavo di ricarica con entrata USB tipo C

 x 2 Kit per fissaggio magnetico

Non inclusi

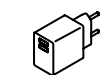
 LD0300UC Carica batterie con doppia entrata USB

 LD0340RA Caricatore multipresa USB (8xUSB)

 LD0300KT Kit per fissaggio meccanico al tavolo *

 BAT04705506701900 Pacco batteria sostitutiva

1. Consigli d'uso:

Questo prodotto serve esclusivamente a scopi di illuminazione e:

A) Non deve essere esposto a pesanti carichi meccanici o forti contaminazioni; **B)** può essere installato e usato solo previo controllo delle condizioni del prodotto; verificare che non risulti sporco e non abbia subito danneggiamenti durante lo stoccaggio; **C)** l'installazione e la manutenzione vanno eseguite ad apparecchio spento; **D)** modifiche o manomissioni del prodotto e il non rispetto delle indicazioni riportate possono rendere l'apparecchio pericoloso; **E)** i prodotti con grado di protezione 65 (IP65) sono idonei per uso esterno; **F)** per la pulizia di tutte le superfici metalliche e plastiche utilizzare un panno morbido asciutto; **G)** La ditta Zafferano declina ogni responsabilità per danni causati da un proprio prodotto montato in modo non conforme alle istruzioni.

2. Dati tecnici:

- Potenza: 3 W
- Volt: DC 5 V
- Flusso luminoso: 2700K 250 lm - 3350K 260 lm - 4000K 270 lm
- LED: HONGLITRONIC 2835 / (8+42 pz) 3 STEP MAC ADAM
- Pacco batteria al litio inclusa: 18650 / 7500mA/H*3; per le istruzioni di sostituzione del pacco batteria consultare il sito web www.zafferanoitalia.com; si raccomanda di usare batterie originali per la sostituzione.
- Ricarica standard: 1A - 2A (max 2,5A)
- Ricarica: 5 ore a 2A - 10 ore a 1A
- Durata batteria: 100% 8 ore - 60% 13 ore - 30% 28 ore - 6% 58 ore
- Classe: III
- Grado di protezione: IP65
- CRI ≥ 90
- In riferimento alla norma UNI EN ISO 9227, la resistenza della lampada all'esposizione a nebbia salina neutra (NSS) è garantita per 1500 ore.

3. Carica batterie:

- Per caricare il prodotto è possibile usare un carica batterie con entrata USB standard A.
- Carica batterie con doppia entrata USB NON INCLUSO: INPUT 100-240 V AC - 50/60Hz; OUTPUT DC 5V - 2.1 A.
- Per un corretto caricamento della lampada si consiglia di: 1 - collegare il cavo USB all'adattatore; 2 - collegare il cavo USB alla lampada; 3 - collegare la spina alla presa elettrica; 4 - a carica completata scollegare la spina dalla presa elettrica e rimuovere il cavo USB.
- La lampada funziona correttamente anche se collegata alla corrente.
- Si consiglia l'utilizzo del caricatore opzionale e del cavo in dotazione originale. In alternativa utilizzare un cavo e caricatore a 2A certificati.

4. Configurazione di fabbrica:

LUMINOSITÀ 100% - K 2700 - CHIAMATA AL TAVOLO OFF - DIMMER ON - FISSAGGIO MECCANICO

5. Attenzione:

- Il piano d'appoggio della lampada non deve superare i 15° di inclinazione o rischia la caduta.
- La batteria è fornita delle seguenti protezioni: cortocircuito, sovra scarica, sovralimentazione, sovracorrente, sovratensione.
- Per preservare l'integrità della batteria si consiglia di mantenere la carica tra il 20% minimo e 80% massimo; se la lampada non viene utilizzata per lunghi periodi, si consiglia di procedere periodicamente ad un ciclo di carica/scarica del prodotto.
- Si prega di fare riferimento alle leggi locali per un corretto smaltimento e riciclaggio della batteria.

Visita il nostro sito per ulteriori informazioni, e aggiornamenti sulle caratteristiche del prodotto.

NON PRODOTTO IN ITALIA - IMPORTATO DA

Zafferano srl, Viale dell'Industria, 26 - 31055 Quinto di Treviso - TV - Italia

www.zafferanoitalia.com



istruzioni d'uso

CONFIGURAZIONE DI FABBRICA

ACCENSIONE / SPEGNIMENTO

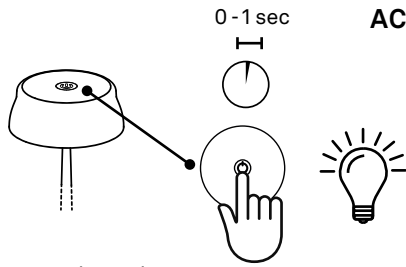

Rapido tocco sul touch per accendere la lampada

1

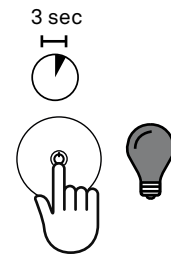

Leggera pressione per 3 secondi per spegnere la lampada

2

DIMMERAZIONE

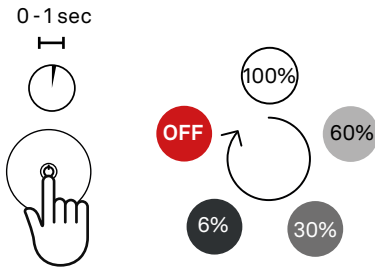

A lampada accesa, rapido tocco per cambiare la luminosità del dispositivo. La ripetizione degli step è ciclica.

ALTRE CONFIGURAZIONI

CHIAMATA AL TAVOLO (SE ON - livello 4 menu configurazione)

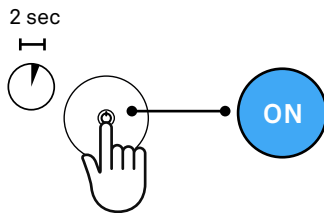

A lampada accesa, leggera pressione per 2 secondi per attivare la chiamata al tavolo

1

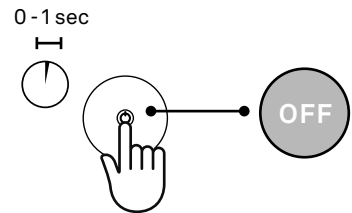

Rapido tocco per disattivare la chiamata al tavolo

2

ACCENSIONE / SPEGNIMENTO (SE DIMMER E CHIAMATA AL TAVOLO OFF - livello 3 e 4 menu configurazione)

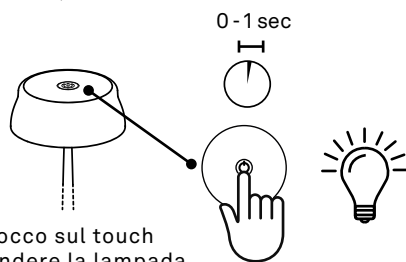

Rapido tocco sul touch per accendere la lampada

1

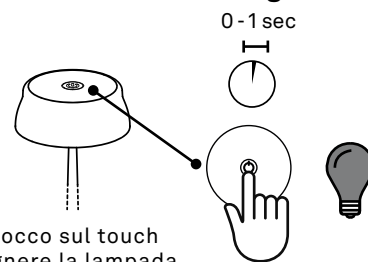

Rapido tocco sul touch per spegnere la lampada

2

LED DI SEGNALEZIONE

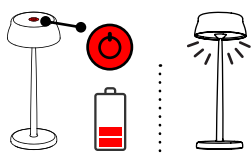

LED ROSSO FISSO: carica della batteria inferiore al 20% si consiglia la ricarica

Quando la carica è esaurita (1%), la lampada non si accende, ma emette tre flash bianchi di allerta - ricaricare

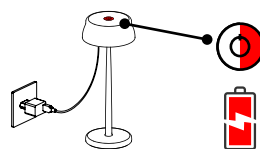

LED ROSSO LAMPEGGIANTE ricarica in corso

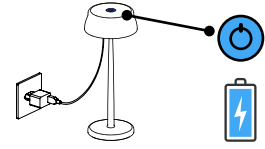

LED BLU FISSO batteria carica al 100% si consiglia di disconnettere dall'unità di ricarica

Visita il nostro sito per ulteriori informazioni, e aggiornamenti sulle caratteristiche del prodotto.

NON PRODOTTO IN ITALIA - IMPORTATO DA

Zafferano srl, Viale dell'Industria, 26 - 31055 Quinto di Treviso - TV - Italia

www.zafferanoitalia.com

configurazione menù



Il menu di configurazione è composto da quattro livelli consecutivi:

- 1) Impostazione della luminosità di default
- 2) Impostazione della temperatura di colore
- 3) Dimmerazione ON - OFF
- 4) Chiamata al tavolo ON - OFF

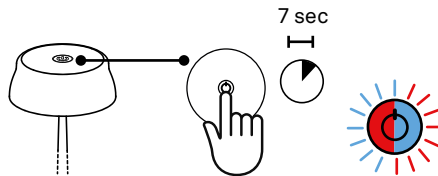

PER ACCEDERE AL MENU (primo livello)
Da lampada spenta, leggera pressione per 7 secondi finché non lampeggia rosso/blu (per 3 volte)

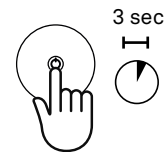

2b)* MEMORIZZARE E USCIRE DAL MENU
Da qualsiasi livello, leggera pressione per 3 secondi per spegnere la lampada

LIVELLO 1 - LUMINOSITÀ DI DEFAULT

0-1 sec

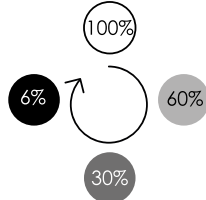
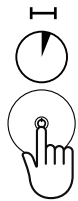

- 1) Rapido tocco per cambiare la luminosità della lampada

1-2 sec

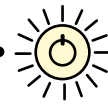

- 2a) **MEMORIZZARE E PASSARE AL LIVELLO 2**
Leggera pressione per 1-2 secondi finché appare un flash
2b)*

LIVELLO 2 - TEMPERATURA DI COLORE

0-1 sec

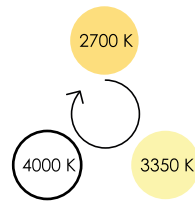
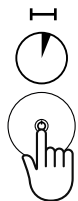

- 1) Rapido tocco per cambiare la temperatura di colore della lampada

1-2 sec

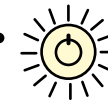

- 2a) **MEMORIZZARE E PASSARE AL LIVELLO 3**
Leggera pressione per 1-2 secondi finché appare un flash
2b)*

LIVELLO 3 - DIMMERAZIONE (LED ROSSO)

0-1 sec

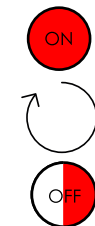
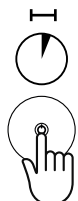

- 1) Rapido tocco per impostare il dimmer ON (LED rosso fisso) o OFF (LED rosso lampeggiante)

1-2 sec

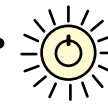

- 2a) **MEMORIZZARE E PASSARE AL LIVELLO 4**
Leggera pressione per 1-2 secondi finché appare un flash
2b)*

LIVELLO 4 - CHIAMATA AL TAVOLO (LED BLU)

0-1 sec

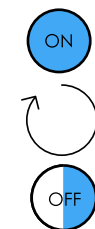
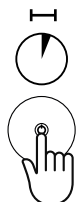

- 1) Rapido tocco per impostare la chiamata al tavolo ON (LED blu fisso) o OFF (LED blu lampeggiante)

1-2 sec

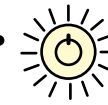

- 2a) **MEMORIZZARE E PASSARE AL LIVELLO 1**
Leggera pressione per 1-2 secondi finché appare un flash
2b)*

Visita il nostro sito per ulteriori informazioni, e aggiornamenti sulle caratteristiche del prodotto.

NON PRODOTTO IN ITALIA - IMPORTATO DA

Zafferano srl, Viale dell'Industria, 26 - 31055 Quinto di Treviso - TV - Italia

www.zafferanoitalia.com



reset delle impostazioni

Ripristino della configurazione di fabbrica

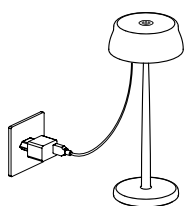

1

Collegare la lampada alla presa di corrente

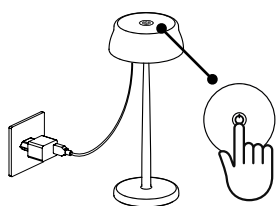

2

Appoggiare il dito sul touch mantenendo la pressione

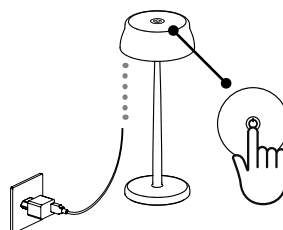

3

Scollegare la lampada dalla presa di corrente

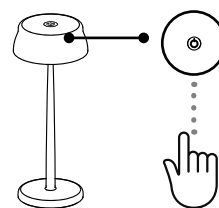

4

Sollevare il dito dal touch

istruzioni di montaggio

Fissaggio magnetico

INCLUSO

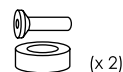

Kit per fissaggio magnetico

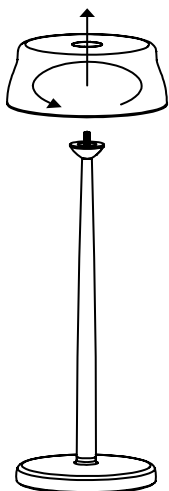

1

Svitare la testa della lampada dal perno filettato

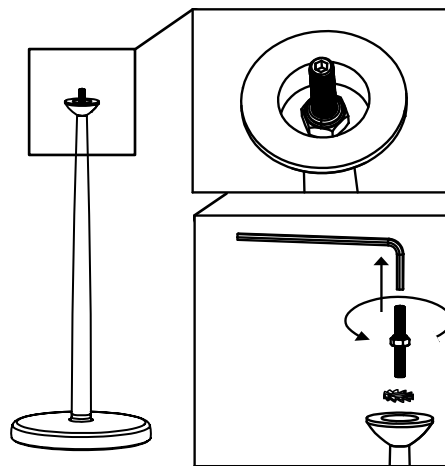

2

Svitare il perno filettato

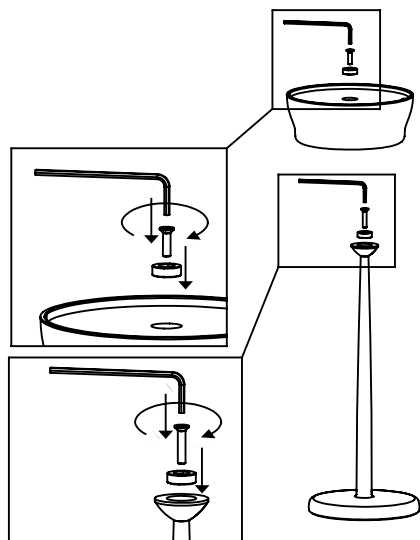

3

Avvitare i magneti

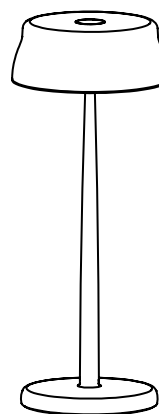

Visita il nostro sito per ulteriori informazioni, e aggiornamenti sulle caratteristiche del prodotto.

NON PRODOTTO IN ITALIA - IMPORTATO DA

Zafferano srl, Viale dell'Industria, 26 - 31055 Quinto di Treviso - TV - Italia

www.zafferanoitalia.com

sister light

Rechargeable table lamp

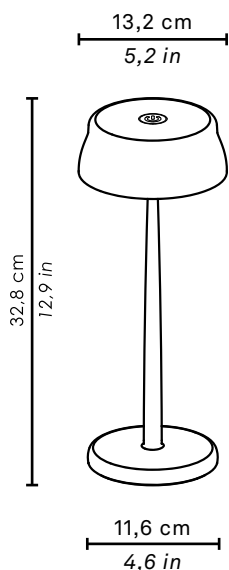

NON-REPLACEABLE LED

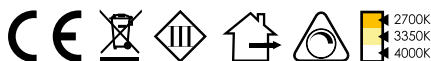

LED DIMMER

3W • 250lm - 260lm - 270lm • 2700K
- 3350K - 4000K • IP65 • 220-240V
50-60Hz • CRI>90 • 5Vdc max 2A
Ø 13,2 x h 32,8 x Ø 11,6 cm
Ø 5,2 x h 12,9 x Ø 4,6 in

LD0300A3 anodized aluminium
LD0300O3 anodized gold
LD0300R3 anodized copper
LD0300B3 anodized blue
LD0300V3 anodized green

* For the assembly instructions
visit our website

Included



Charging cable
with USB Type C input



Magnetic fixing kit

Not included

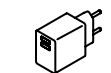

LD0300UC
Dual USB port power
charger



LD0340RA
Multi-socket USB charger
(8xUSB)



LD0300KT
Fixing kit to the table *



BAT04705506701900
Replacement battery pack

1. Tips for use:

This product is exclusively for lighting purposes and:

A) It must not be exposed to heavy mechanical loads or contamination; **B)** It can be installed and used only after checking the state of the product; check that is not dirty and has not been damaged during storage; **C)** Installation and maintenance must be carried out when the appliance is switched off; **D)** Any alterations to the product, any tampering and any failure to comply with the instructions provided may make the appliance hazardous; **E)** Products with IP65 protection are suitable for outdoor use; **F)** All metal and plastic surfaces should be cleaned with a soft dry cloth; **G)** The company Zafferano shall not be held liable for any damage caused due to its products being assembled in any manner that does not comply with the instructions provided.

2. Technical data:

- Power: 3 W
- Volt: DC 5 V
- Lumen lamp: 2700K 148 lm - 3350K 158 lm - 4000K 166 lm
- LED: HONGLITRONIC 2835 / (8+42 pz) 3 STEP MAC ADAM
- Lithium battery pack included: 18650 / 7500mA/H*3; for instructions about how to replace the battery pack, please consult the website: www.zafferanoitalia.com. We recommend using an original battery pack as a replacement.
- Standard charge: 1A - 2A (max 2,5A)
- Charge: 1A 10 h - 2A 5 h
- Battery life: 100% 8 h - 60% 13 h - 30% 28 h - 6% 58 h
- Class: III
- Protection rating: IP65
- CRI≥90
- With reference to the UNI EN ISO 9227 standard, the lamp is guaranteed to resist exposure to neutral salt spray (NSS) for 1,500 hours.

3. Charger:

- You can use a charger with Standard-A USB to charge this product.
- *Dual USB port power charger NOT INCLUDED*: INPUT 100-240 V AC - 50/60Hz; OUTPUT DC 5V - 2.1 A.
- To correctly charge the lamp, we recommend that you: 1- Connect the USB cable to the adaptor; 2- Connect the USB cable to the lamp; 3- Put the plug into the electrical socket; 4- When fully charged, disconnect the plug from the electrical socket and remove the USB cable.
- The lamp also operates properly when connected to the mains power supply.
- We recommend using an optional charger and the original cable provided. Alternatively, use a certified cable and a 2A charger.

4. Manufacturer's configuration:

100% LUMINOSITY - 2700K - CALL TO TABLE OFF - DIMMER ON - MECHANICAL FIXING

5. Important!

- The support surface for the lamp must not exceed a 15° tilt or it will fall.
- The battery is provided with the following protection functions: short circuit, over discharge, over charge, over current, over voltage.
- To preserve the integrity of the battery, we recommend keeping the charge between minimum 20% and maximum 80%; if the lamp is not used for long periods, it is advisable to regularly charge/discharge the product.
- Please refer to local laws for the proper disposal and recycling of the battery.



instructions for use

MANUFACTURER'S CONFIGURATION

SWITCHING ON / OFF

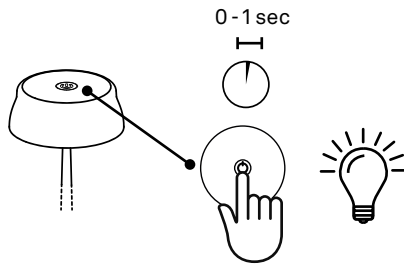

Quickly press the touch sensor to switch on the lamp **1**

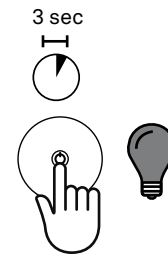

Press lightly for 3 seconds to switch off the lamp **2**

DIMMER FUNCTION

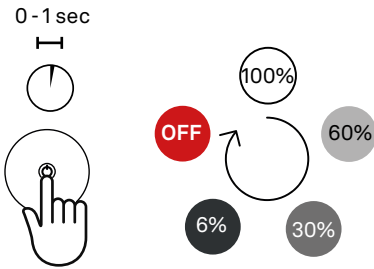

When the lamp is switched on, quickly press the touch sensor to change the luminosity of the appliance. Cyclical step repetition.

OTHER CONFIGURATIONS

CALL TO THE TABLE (IF ON - step 4 of the configuration menu)

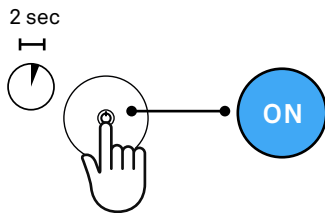

When the lamp is switched on, press lightly for 2 seconds to activate the call to table function **1**

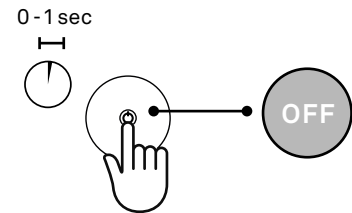

Quickly press the touch sensor to deactivate the call to table **2**

SWITCHING ON / OFF (IF DIMMER AND CALL TO THE TABLE FUNCTIONS ARE OFF - step 3 and 4 of the configuration menu)

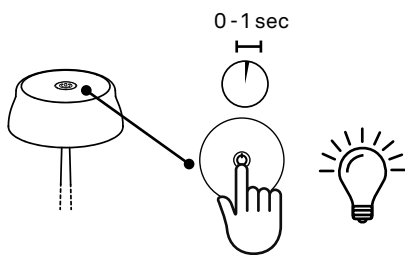

Quickly press the touch sensor to switch on the lamp **1**

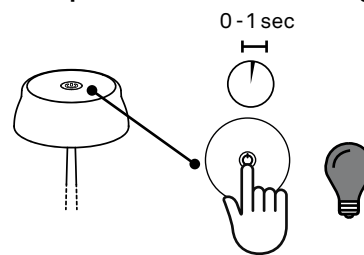

Quickly press the touch sensor to switch off the lamp **2**

INDICATOR LEDS

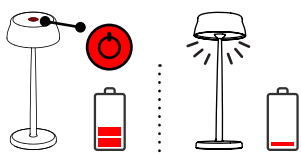

PERMANENT RED LED
the battery charge is lower than 20%, charging is recommended.
When the charge is depleted (1%), the lamp does not switch on but emits three white flashes as an alert to charge

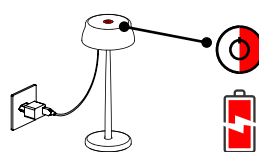

FLASHING RED LED
charging in progress

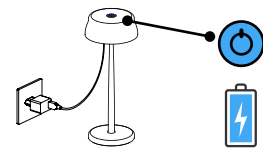

PERMANENT BLUE LED
the battery is 100% charged, disconnection from the power charger is recommended

For more information and updates visit our website

NOT PRODUCED IN ITALY - IMPORTED BY

Zafferano srl, Viale dell'Industria, 26 - 31055 Quinto di Treviso - TV - Italy

www.zafferanoitalia.com

configuration menu



The configuration menu involves four successive setting steps:

- 1) Default luminosity
- 2) Colour temperature (dynamic white)
- 3) Dimmer ON / OFF function
- 4) Call to table ON / OFF function

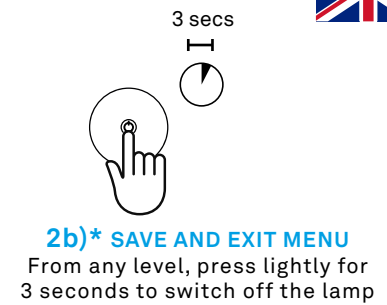
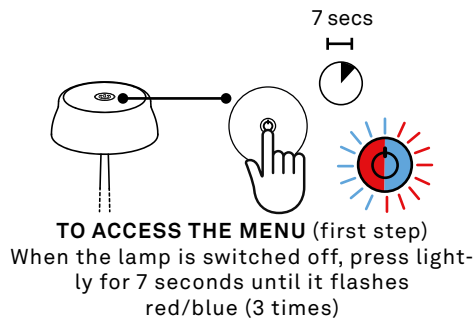

STEP 1 - DEFAULT LUMINOSITY

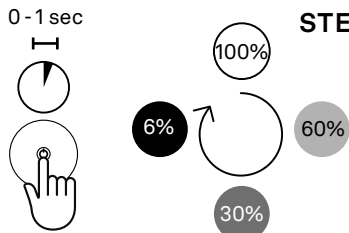

- 1) Quickly press the touch sensor to change the luminosity of the lamp

- 2a) **SAVE AND CONTINUE TO STEP 2**
Press lightly for 1-2 seconds until a flash appears
- 2b)*

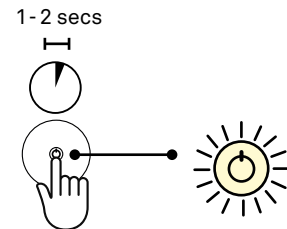

STEP 2 - COLOUR TEMPERATURE (K) dynamic white

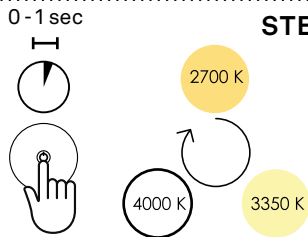

- 1) Quickly press the touch sensor to change the colour temperature of the lamp

- 2a) **SAVE AND CONTINUE TO STEP 3**
Press lightly for 1-2 seconds until a flash appears
- 2b)*

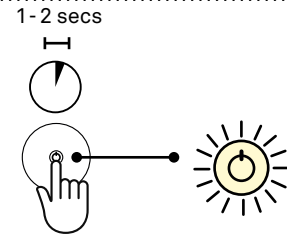

STEP 3 - DIMMER (RED LED)

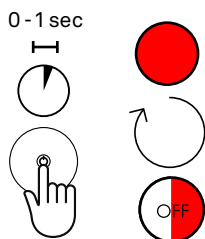

- 1) Quickly press the touch sensor to set the dimmer function to ON (permanent red LED) or OFF (flashing red LED)

- 2a) **SAVE AND CONTINUE TO STEP 4**
Press lightly for 1-2 seconds until a flash appears
- 2b)*

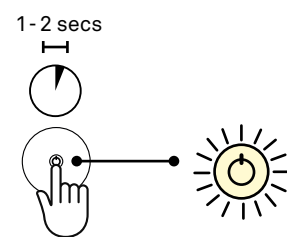

STEP 4 - CALL TO TABLE (BLUE LED)

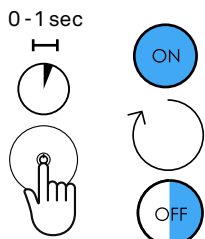

- 1) Quickly press the touch sensor to set the call to table function to ON (permanent blue LED) or OFF (flashing blue LED)

- 2a) **SAVE AND CONTINUE TO STEP 1**
Press lightly for 1-2 seconds until a flash appears
- 2b)*

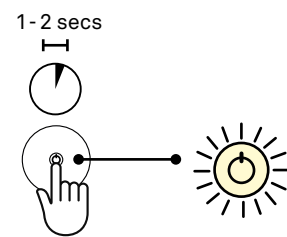



resetting the settings

Restoring the manufacturer's setting

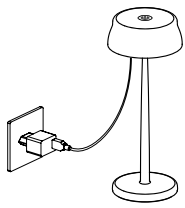

1

Plug the lamp into the electric socket

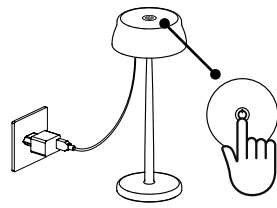

2

Place a finger on the touch sensor and keep it pressed down

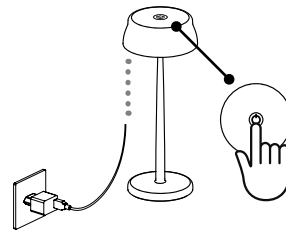

3

Unplug the lamp from the electric socket

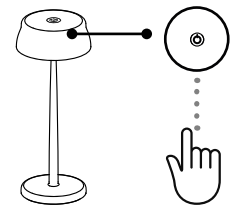

4

Remove your finger from the touch sensor

assembly instructions

Magnetic fixing

INCLUDED

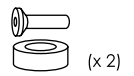

Magnetic fixing kit

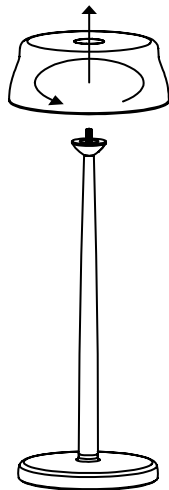

1

Unscrew the top of the lamp from the threaded pin

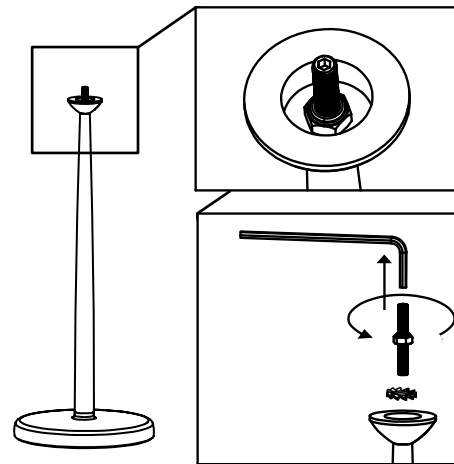

2

Unscrew the threaded pin

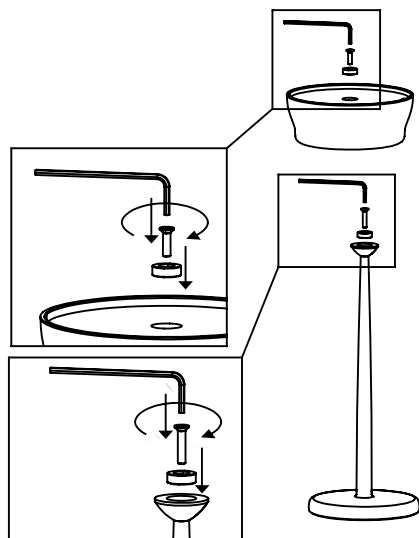

3

Screw the magnets

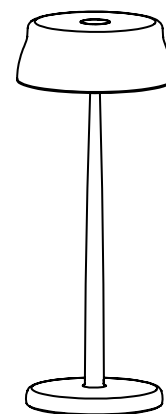

For more information and updates visit our website

NOT PRODUCED IN ITALY - IMPORTED BY

Zafferano srl, Viale dell'Industria, 26 - 31055 Quinto di Treviso - TV - Italy

www.zafferanoitalia.com

sister light

AUFLADBARE TISCHLAMP

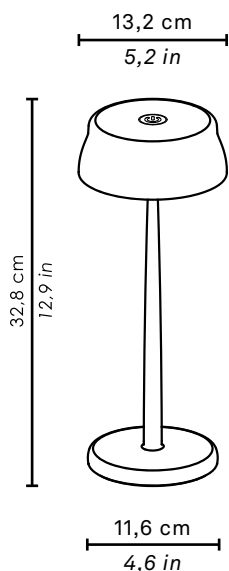

LED NICHT AUSTAUSCHBAR

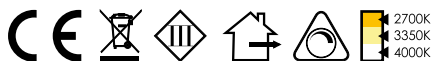

LED DIMMER

3W • 250lm - 260lm - 270lm • 2700K
- 3350K - 4000K • IP65 • 220-240V
50-60Hz • CRI>90 • 5Vdc max 2A
Ø 13,2 x h 32,8 x Ø 11,6 cm
Ø 5,2 x h 12,9 x Ø 4,6 in

LD0300A3 eloxiertes Aluminium
LD0300O3 eloxiertes Gold
LD0300R3 eloxiertes Kupfer
LD0300B3 eloxiertes Blau
LD0300V3 eloxiertes Grün

*Montageanleitungen finden Sie auf der Website

Inbegriffen

USB-Ladekabel Typ C

x 2 Magnetbefestigungssatz

Nicht enthalten

LD0300UC
Ladegerät mit doppeltem USB-Eingang

LD0340RA
Ladegerät (8xUSB)

LD0300KT
Set für Befestigung am Tisch *

BAT04705506701900
Ersatzakku

1. Hinweise zur Verwendung:

Dieses Produkt dient ausschließlich zur Beleuchtung und:

A) Darf keinen starken mechanischen Belastungen oder starken Kontaminationen ausgesetzt werden; **B)** kann nur, nachdem der Zustand des Produkts kontrolliert wurde, installiert und verwendet werden; prüfen, dass es nicht schmutzig ist und während der Lagerung nicht beschädigt wurde; **C)** Das Gerät muss ausgeschaltet, installiert oder gewartet werden; **D)** Durch die Veränderung oder Manipulation des Produkts und die Nichteinhaltung dieser Anweisungen kann das Gerät gefährlich werden; **E)** Produkte mit Schutzgrad 65 (IP65) können im Freien verwendet werden; **F)** Zur Reinigung aller Metall- oder Plastikoberflächen ein trockenes, weiches Tuch verwenden; **G)** Die Firma Zafferano lehnt jede Verantwortung für Schäden ab, die durch eines ihrer Produkte, das nicht gemäß der gelieferten Anweisungen montiert wurde, entstehen.

2. Technische Daten:

- Leistung: 3 W
- Volt: DC 5 V
- Absoluter Lichtstrom: 2700K 148 lm - 3350K 158 lm - 4000K 166 lm
- LED: HONGLITRONIC 2835 / (8+42 pz) 3 STEP MAC ADAM
- Eine Lithiumbatterie ist in der Lieferung enthalten: 18650 / 7500mA/H*3; zu den Anweisungen zum Auswechseln der Batterie schauen Sie bitte auf die Webseite www.zafferanoitalia.com. Die Batterie sollte nur durch eine Originalbatterie ersetzt werden.
- Standardaufladung: 1A - 2A (max 2,5A)
- Aufladezeit: 5 Std 2A - 10 Std 1A
- Batteriedauer: 100% 8 Std - 60% 13 Std - 30% 28 Std - 6% 58 Std
- Klasse: III
- Schutzgrad: IP65
- CRI≥90
- Unter Bezugnahme auf die Norm DIN EN ISO 9227 hat die Lampe bei der neutralen Salzsprühnebelprüfung (NSS) eine Korrosionsbeständigkeit von 1500 Stunden.

3. Ladegerät:

- Um das Produkt aufzuladen, können Aufladegeräte mit Mikro verwendet werden.
- Ladegerät mit doppeltem USB-Eingang NICHT ENTHALTEN: INPUT 100-240 V AC - 50/60Hz; OUTPUT DC 5V - 2.1 A.
- Um die Lampe korrekt aufzuladen, sollte man: 1- Das USB-Kabel an den Adapter anschließen; 2- Das USB-Kabel an die Lampe anschließen; 3- Den Stecker in die Steckdose stecken; 4- Wenn die Lampe aufgeladen ist, den Stecker aus der Steckdose ziehen und das USB-Kabel von der Lampe trennen.
- Die Lampe funktioniert auch mit Stromanschluss korrekt.
- Wir raten dazu, das optionale Ladegerät und das mitgelieferte Kabel zu verwenden. Als Alternative ein zertifiziertes 2A-Kabel und Ladegerät verwenden.

4. Werkskonfiguration:

HELLIGKEIT 100% - K 2700 - TISCHRUF AUS - DIMMER AN - MECHANISCHE BEFESTIGUNG

5. Achtung:

- Die Standfläche der Lampe darf keine höhere Neigung als 15° besitzen, sonst fällt diese um.
- Die Batterie ist abgesichert gegen: Kurzschluss, Überentlastung, Überbelastung, Überstrom, Überspannung.
- Um die Lebensdauer des Akkus zu erhalten, sollte sein Ladestand zwischen 20 und 80 Prozent liegen. Wenn die Lampe lange Zeit nicht benutzt wird, sollte der Akku regelmäßig ent- und wieder aufgeladen werden.
- Die Batterie muss entsprechend der geltenden, lokalen Vorschriften zur Abfallentsorgung und -wiederverwertung behandelt werden.

Zu weiteren Informationen und Aktualisierungen der Produktkennzeichen besuchen Sie bitte unsere Webseite.

NICHT IN ITALIEN PRODUZIERT - IMPORTIERT VON

Zafferano srl, Viale dell'Industria, 26 - 31055 Quinto di Treviso - TV - Italien

www.zafferanoitalia.com



gebrauchsanweisung

WERKSKONFIGURATION

EIN-/AUSSCHALTEN

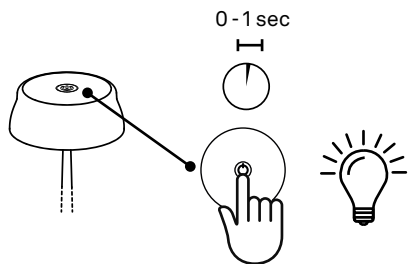

1

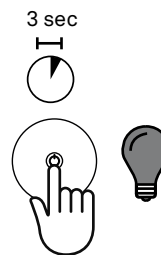

2

Die Taste kurz drücken und die Lampe geht an.

Die Taste 3 Sekunden lang drücken, die Lampe geht aus.

LICHT DIMMEN

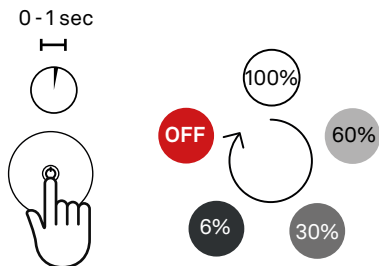

Wenn die Lampe an ist, kurz berühren, um die Helligkeit zu ändern. Die Wiederholung der Dimmstufen ist zyklisch.

ANDERE KONFIGURATIONEN

TISCHRUF (WENN ON - Ebene 4 Konfigurationsmenü)

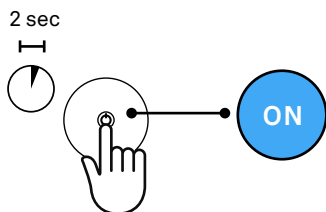

1

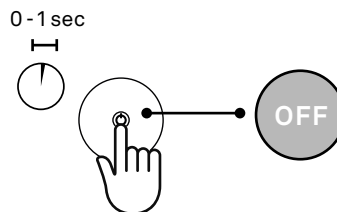

2

Wenn die Lampe an ist, 2 Sekunden lang drücken, um den Tischruf zu aktivieren.

Kurz berühren, um den Tischruf zu deaktivieren.

EIN-/AUSSCHALTEN (WENN DIMMER UND TISCHRUF OFF - Ebene 3 und 4 Konfigurationsmenü)

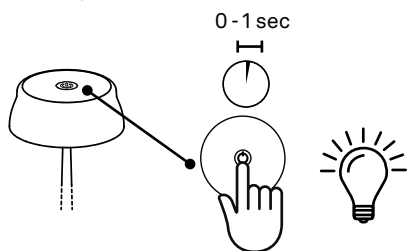

1

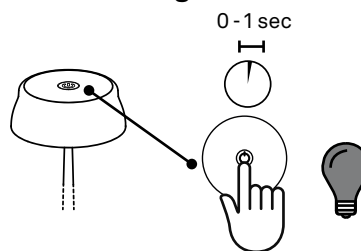

2

Die Taste kurz drücken und die Lampe geht an.

Die Taste kurz drücken und die Lampe geht aus.

LEDANZEIGE

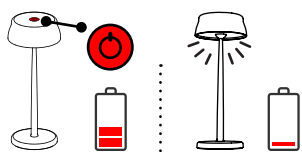

LED LEUCHTET ROT

Batterieladung unter 20%. Die Batterie sollte aufgeladen werden
Wenn die Batterie entladen ist (1%), geht die Lampe nicht an, blinkt aber dreimal weiß auf - aufladen

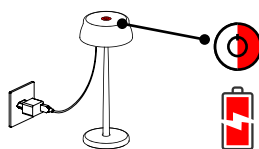

LED BLINKT ROT Wird aufgeladen

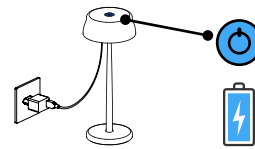

LED LEUCHTET BLAU Batterie zu 100% aufgeladen. Die Batterie vom Ladegerät trennen

Zu weiteren Informationen und Aktualisierungen der Produktkennzeichen besuchen Sie bitte unsere Webseite.

NICHT IN ITALIEN PRODUZIERT - IMPORTIERT VON

Zafferano srl, Viale dell'Industria, 26 - 31055 Quinto di Treviso - TV - Italien

www.zafferanoitalia.com

menü-konfiguration



Das Konfigurationsmenü besteht aus vier aufeinanderfolgenden Ebenen:

- 1) Einstellung der Ausgangshelligkeit
- 2) Einstellung der Farbtemperatur (dynamisches Weiß)
- 3) Dimmer AN - AUS
- 4) Tischruf AN - AUS

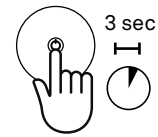
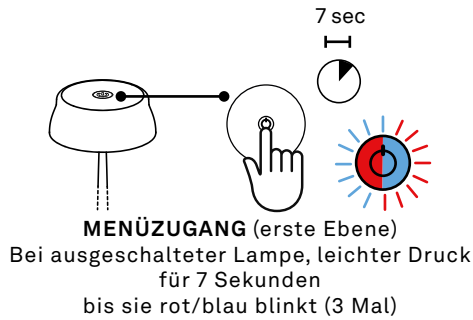

2b)* SPEICHERN UND DAS MENÜ VERLASSEN

Von jedem Niveau aus, 3 Sekunden lang leicht drücken, damit die Lampe ausgeht

0-1 sec

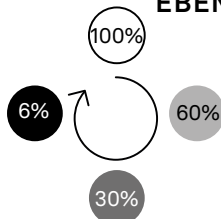
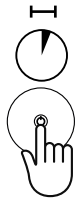

EBENE 1 - AUSGANGSHELLIGKEIT

1-2 sec



- 1) Kurz berühren, um die Helligkeit der Lampe zu verändern

- 2a) **SPEICHERN UND ZU EBENE 2 ÜBERGEHEN**
1-2 Sekunden lang leicht drücken, bis sie aufleuchtet
2b)*

0-1 sec

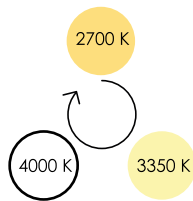
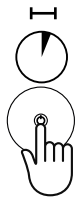

EBENE 2 - FARBTEMPERATUR (K) (dynamisches Weiß)

1-2 sec

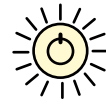

- 1) Kurz berühren, um die Farbtemperatur der Lampe zu verändern

- 2a) **SPEICHERN UND ZU EBENE 3 ÜBERGEHEN**
1-2 Sekunden lang leicht drücken, bis sie aufleuchtet
2b)*

0-1 sec

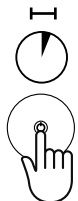

EBENE 3 - DIMMER (LED ROT)

1-2 sec

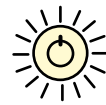

- 1) Kurz berühren, um den Dimmer auf AN (LED leuchtet rot) oder AUS (LED blinkt rot) zu stellen.

- 2a) **SPEICHERN UND ZU EBENE 4 ÜBERGEHEN**
1-2 Sekunden lang leicht drücken, bis sie aufleuchtet
2b)*

0-1 sec



EBENE 4 - TISCHRUF (LED BLAU)

1-2 sec



- 1) Kurz berühren, um den Tischruf auf AN (LED leuchtet blau) oder AUS (LED blinkt blau) zu stellen.

- 2a) **SPEICHERN UND ZU EBENE 1 ÜBERGEHEN**
1-2 Sekunden lang leicht drücken, bis sie aufleuchtet
2b)*

Zu weiteren Informationen und Aktualisierungen der Produktkennzeichen besuchen Sie bitte unsere Webseite.

NICHT IN ITALIEN PRODUZIERT - IMPORTIERT VON

Zafferano srl, Viale dell'Industria, 26 - 31055 Quinto di Treviso - TV - Italien

www.zafferanoitalia.com



reset der einstellungen

Wiederherstellung der Werkskonfiguration

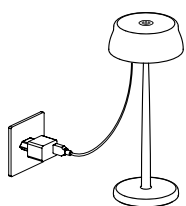

1

Den Stecker der Lampe in die Steckdose stecken

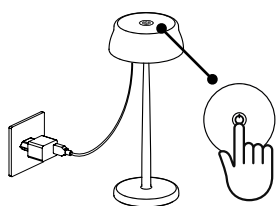

2

Mit dem Finger auf das Touchfeld drücken

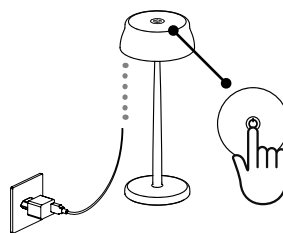

3

Den Stecker der Lampe aus der Steckdose ziehen

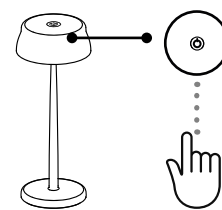

4

Den Finger vom Touchfeld nehmen

montageanleitung

Magnetische Befestigung

INBEGRIFFEN



(x 2)

Magnetbefestigungssatz

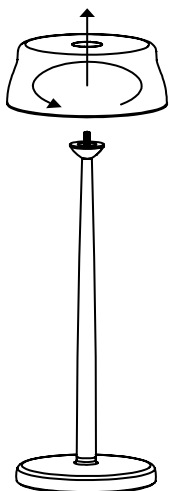

1

Den Lampenkopf vom Gewindestift schrauben

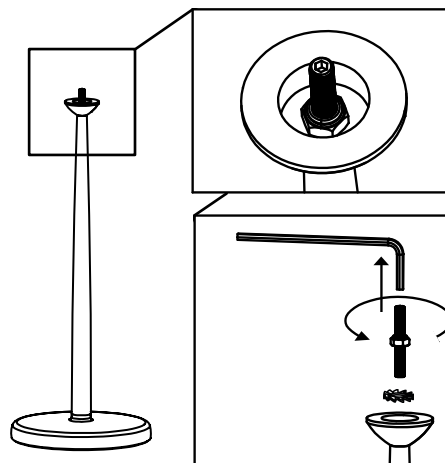

2

Den Gewindestift schrauben

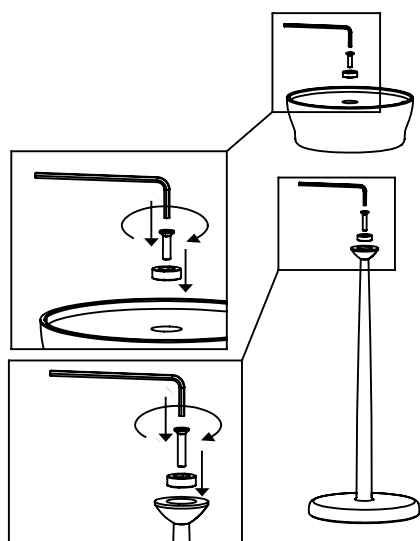

3

Magneten anschrauben

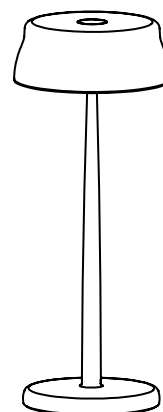

Zu weiteren Informationen und Aktualisierungen der Produktkennzeichen besuchen Sie bitte unsere Webseite.

NICHT IN ITALIEN PRODUZIERT - IMPORTIERT VON

Zafferano srl, Viale dell'Industria, 26 - 31055 Quinto di Treviso - TV - Italien

www.zafferanoitalia.com

sister light

lampe de table rechargeable

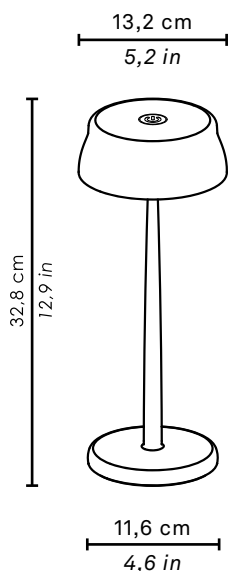

LED NON REMPLAÇABLE

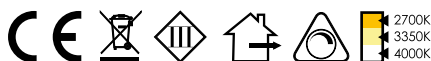

LED DIMMER

3W • 250lm - 260lm - 270lm • 2700K
- 3350K - 4000K • IP65 • 220-240V
50-60Hz • CRI>90 • 5Vdc max 2A
Ø 13,2 x h 32,8 x Ø 11,6 cm
Ø 5,2 x h 12,9 x Ø 4,6 in

LD0300A3 aluminium anodisé
LD0300O3 or anodisé
LD0300R3 cuivre anodisé
LD0300B3 bleu anodisé
LD0300V3 vert anodisé

* Les notice de montage
sont disponibles sur le site web

Inclus



Câble de recharge avec
entrée USB type C



Kit pour fixation
magnétique

Non inclus



LD0300UC
Chargeur de batteries à
double entrée USB



LD0340RA
Station de charge multiple
(8xUSB)



LD0300KT
Kit pour fixation à la table*



BAT04705506701900
Batterie de remplacement

1. Conseils d'utilisation:

Ce produit sert exclusivement pour éclairer et:

A) Ne doit pas être exposé à de lourdes charges mécaniques ou à de fortes contaminations; **B)** Peut être installé et utilisé uniquement après avoir contrôlé les conditions du produit; vérifier s'il n'est pas sale et s'il n'a pas subi de dommages durant le stockage; **C)** L'installation et l'entretien doivent être effectués lorsque l'appareil est éteint; **D)** Les modifications ou les altérations du produit et le non-respect des indications fournies peuvent rendre l'appareil dangereux; **E)** Les produits avec un degré de protection 65 (IP65) sont adaptés à une utilisation externe; **F)** Pour le nettoyage de toutes les surfaces métalliques et plastiques, utiliser un chiffon souple et sec; **G)** La société Zafferano décline toute responsabilité pour les dommages provoqués par un produit monté de manière non conforme par rapport aux instructions.

2. Données techniques:

- Puissance: 3 W
- Voltage: DC 5 V
- Flux lumineux: 2700K 250 lm - 3350K 260 lm - 4000K 270 lm
- LED: HONGLITRONIC 2835 /(8+42 pz) 3 STEP MAC ADAM
- Batteries au lithium inclus: 18650 / 7500mA/H*3; visiter le site www.zafferanoitalia.com pour avoir les indications de son remplacement. Pour le remplacement, il est recommandé l'usage d'un assemblage-batteries original.
- Standard recharge: 1A - 2A (max 2,5A)
- Recharge: 5 h 2A - 10 h 1A
- Durée de la batterie: 100% 8 h - 60% 13 h - 30% 28 h - 6% 58 h
- Classe: III
- Degré de protection: IP65
- CRI≥90
- Conformément à la norme UNI EN ISO 9227, la résistance de la lampe à l'exposition au brouillard salin neutre (NSS) est garantie pendant 1500 heures.

3. Chargeur de batterie:

- Pour recharger le produit, il est possible d'utiliser le chargeur de batterie USB standard A.
- Chargeur de batteries à double entrée USB - NON INCLUS: INPUT 100-240 V AC - 50/60Hz; OUTPUT DC 5V - 2.1 A.
- Pour recharger la lampe correctement, il est conseillé de: 1- brancher le câble USB à l'adaptateur; 2- brancher le câble USB à la lampe; 3- insérer la fiche dans la prise de courant; 4- lorsque la lampe est rechargée, retirer la fiche de la prise de courant et enlever le câble USB.
- La lampe fonctionne correctement, même si elle est raccordée au courant.
- Il est recommandé l'usage du chargeur optionnel et du câble original en dotation. Comme alternative, utiliser un câble et un chargeur certifiés à 2A.

4. Configuration d'usine:

LUMINOSITE 100% - K 2700 – APPEL À LA TABLE OFF - DIMMER ON – FIXATION MÉCANIQUE

5. Attention:

- Le plan d'appui de la lampe ne doit pas dépasser 15° d'inclinaison, sinon elle risque de tomber.
- La batterie est fournie avec les protections suivantes: court-circuit, sous-charge, surcharge, surintensité, surtension.
- Pour préserver l'intégrité de la batterie, il est conseillé de maintenir la charge entre 20% minimum et 80% maximum; si la lampe n'est pas utilisée pendant de longues périodes, il est conseillé de procéder périodiquement à un cycle de charge/décharge du produit.
- Se référer aux lois locales pour une élimination correcte et le recyclage de la batterie.

Visitez notre site pour recevoir d'autres informations et des mises à jour sur les caractéristiques du produit

NON FABRIQUE EN ITALIE - IMPORTE PAR

Zafferano srl, Viale dell'Industria, 26 - 31055 Quinto di Treviso - TV - Italie

www.zafferanoitalia.com



mode d'emploi

CONFIGURATION D'USINE

ALLUMAGE / COUPURE

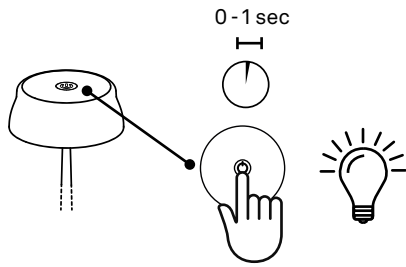

1 Toucher rapidement la fonction Touch pour allumer la lampe

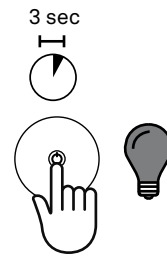

2 Pression légère pendant 3 secondes pour éteindre la lampe

VARIATION DE L'INTENSITE LUMINEUSE

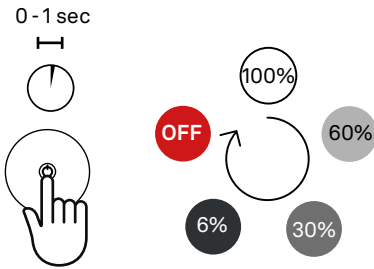

Lorsque la lampe est allumée, toucher rapidement pour changer la luminosité du dispositif. La répétition des phases de la variation de la lumière est cyclique.

D'AUTRES CONFIGURATIONS

APPEL À LA TABLE (SI ON - niveau 4 configuration menu)

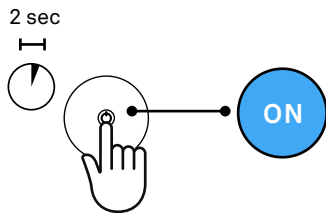

1 Lorsque la lampe est allumée, une légère pression pendant 2 secondes active l'appel à la table

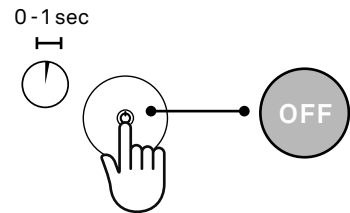

2 Toucher rapidement pour désactiver l'appel à la table

ALLUMAGE / COUPURE (SI DIMMER ET APPEL À LA TABLE OFF - niveau 3 et 4 configuration menu)

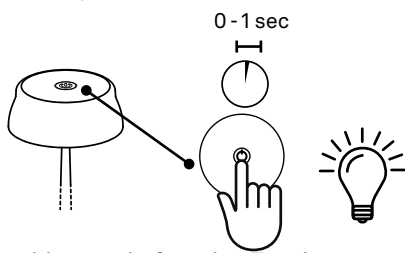

1 Toucher rapidement la fonction Touch pour allumer la lampe

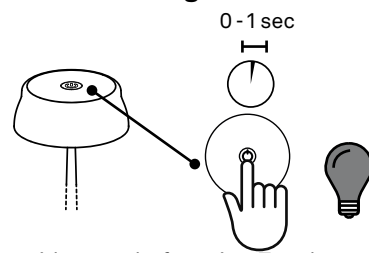

2 Toucher rapidement la fonction Touch pour éteindre la lampe

LED DE SIGNALISATION

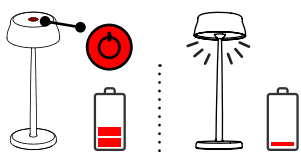

LED ROUGE FIXE: charge de la batterie inférieure à 20%, nous vous conseillons de la recharger. Lorsque la charge est épuisée (1%), la lampe ne s'allume pas, mais elle émet trois flashes blanc d'alarme - recharger

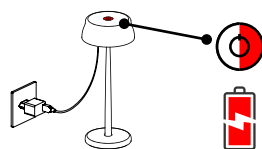

LED ROUGE CLIGNOTANTE recharge en cours

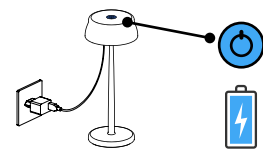

LED BLEUE FIXE: batterie rechargée à 100%, nous vous conseillons de la débrancher de l'unité de recharge

Visitez notre site pour recevoir d'autres informations et des mises à jour sur les caractéristiques du produit

configuration menu



Le menu de configuration est composé de quatre niveaux consécutifs:

- 1) Réglage de la luminosité par défaut
- 2) Réglage de la température de couleur
- 3) Dimmer ON - OFF
- 4) Appel à la table ON - OFF

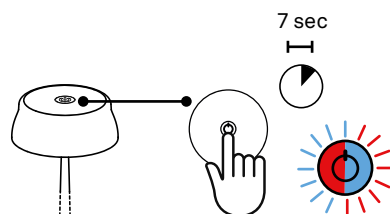

POUR ACCEDER AU MENU (premier niveau)
Avec la lampe éteinte, pression légère pendant 7 secondes jusqu'à ce qu'elle clignote rouge/bleu (3 fois)

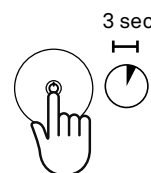

2b)*MEMORISER ET SORTIR DU MENU

A partir de n'importe quel niveau, Pression légère pendant 3 secondes pour éteindre la lampe.

0-1 sec

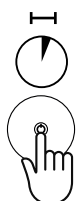

NIVEAU 1 – LUMINOSITE PAR DEFAULT

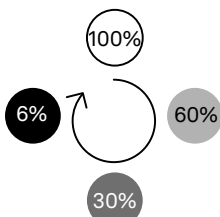

- 1) Toucher rapidement pour changer la luminosité de la lampe

1-2 sec

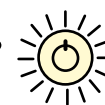

- 2a) MEMORISER ET PASSER AU NIVEAU 2: Pression légère pendant 1-2 secondes jusqu'à ce qu'un flash apparaisse
- 2b)*

0-1 sec

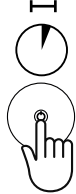

NIVEAU 2 – TEMPERATURE DE COULEUR (blanc dynamique)

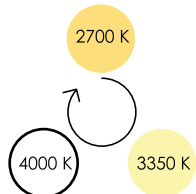

- 1) Toucher rapidement pour changer la température de couleur de la lampe

1-2 sec

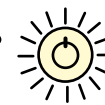

- 2a) MEMORISER ET PASSER AU NIVEAU 3: Pression légère pendant 1-2 secondes jusqu'à ce qu'un flash apparaisse
- 2b)*

0-1 sec

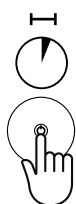

NIVEAU 3 - DIMMER (LED ROUGE)



- 1) Toucher rapidement pour régler le dimmer ON (LED rouge fixe) ou OFF (LED rouge clignotante)

1-2 sec

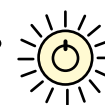

- 2a) MEMORISER ET PASSER AU NIVEAU 4: Pression légère pendant 1-2 secondes jusqu'à ce qu'un flash apparaisse
- 2b)*

0-1 sec

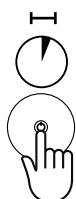

NIVEAU 4 – APPEL A LA TABLE (LED BLEUE)

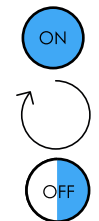

- 1) Toucher rapidement pour régler l'appel à la table ON (LED bleue fixe) ou OFF (LED bleue clignotante)

1-2 sec

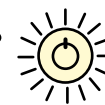

- 2a) MEMORISER ET PASSER AU NIVEAU 1: Pression légère pendant 1-2 secondes jusqu'à ce qu'un flash apparaisse
- 2b)*

Visitez notre site pour recevoir d'autres informations et des mises à jour sur les caractéristiques du produit



réinstallation des paramètres

Rétablissement de la configuration d'usine

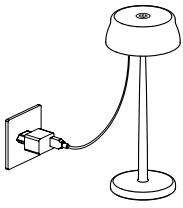

1

Connecter la lampe à la prise de courant

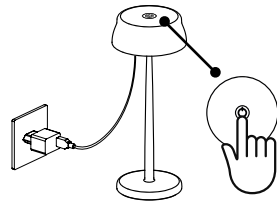

2

Toucher la fonctionne Touch en maintenant la pression

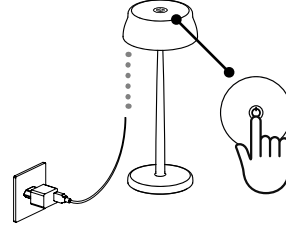

3

Débrancher la lampe da la prise de courant

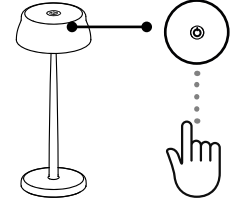

4

Lever le doigt de la fonctionne Touch

notice de montage

Fixation magnétique

INCLUS

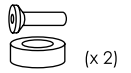

Kit pour fixation magnétique

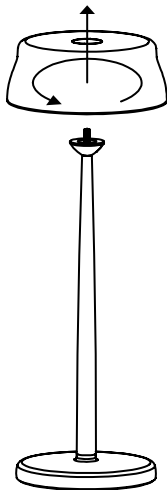

1

Dévisser la tête de lampe de la tige filetée

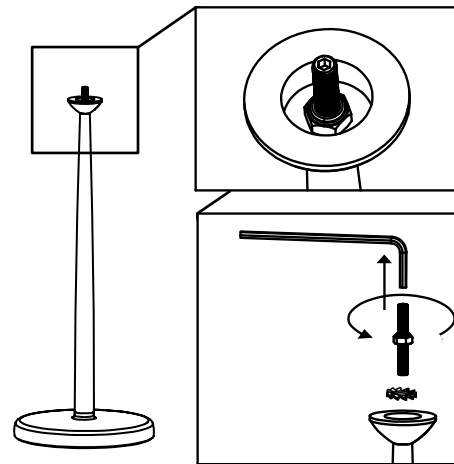

2

Dévisser la tige filetée

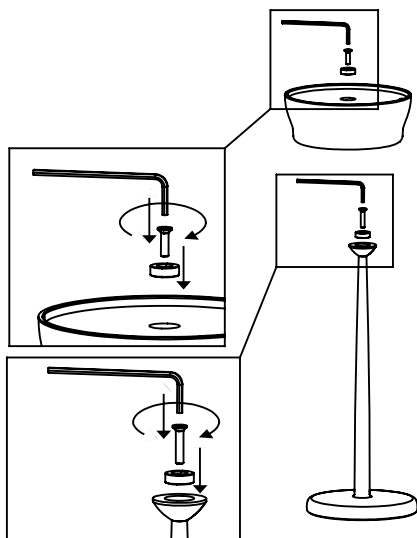

3

Visser les aimants

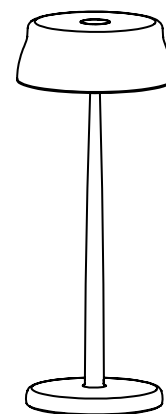

Visitez notre site pour recevoir d'autres informations et des mises à jour sur les caractéristiques du produit

NON FABRIQUE EN ITALIE - IMPORTE PAR

Zafferano srl, Viale dell'Industria, 26 - 31055 Quinto di Treviso - TV - Italie
www.zafferanoitalia.com

sister light

lámpara de mesa recargable

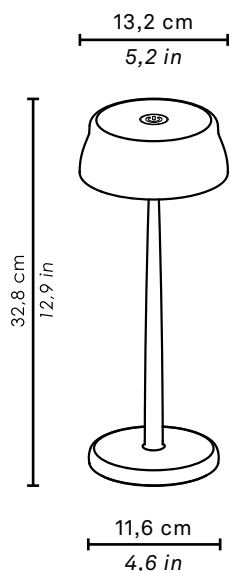

LED NO REEMPLAZABLE

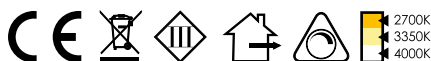

LED DIMMER

3W • 250lm - 260lm - 270lm • 2700K
- 3350K - 4000K • IP65 • 220-240V
50-60Hz • CRI>90 • 5Vdc max 2A
Ø 13,2 x h 32,8 x Ø 11,6 cm
Ø 5,2 x h 12,9 x Ø 4,6 in

LD0300A3 aluminio anodizado
LD0300O3 oro anodizado
LD0300R3 cobre anodizado
LD0300B3 azul anodizado
LD0300V3 verde anodizado

* para instrucciones de montaje visitar el sitio web

Incluido

Cable de recarga con entrada USB Tipo C

x 2 kit para fijación magnética

No incluido

LD0300UC Cargador de batería con doble entrada USB

LD0340RA Cargador múltiple USB (8xUSB)

LD0300KT Kit de fijación para mesa*

BAT04705506701900 Paquete batería sustitutiva

1. Consejos de uso:

Este producto debe utilizarse exclusivamente para iluminación y:

A) No debe ser expuesto a cargas mecánicas pesadas o contaminaciones fuertes; **B)** solo puede ser instalado y utilizado previo control de las condiciones del producto; verificar que no resulte estar sucio y no ha haya sido dañado durante el almacenamiento; **C)** la instalación y el mantenimiento deben realizarse con el aparato apagado; **D)** las modificaciones o las manipulaciones del producto y el incumplimiento de las indicaciones mostradas pueden hacer que el aparato sea peligroso; **E)** los productos con grado de protección 65 (IP65) son adecuados para uso externo; **F)** para la limpieza de todas las superficies metálicas y de plástico utilizar un paño suave y seco; **G)** La empresa Zafferano declina cualquier responsabilidad por los daños causados por un producto suyo montado de manera no conforme con las instrucciones.

2. Datos técnicos:

- Potencia: 3 W
- Voltios: DC 5 V
- Flujo luminoso: 2700K 250 lm - 3350K 260 lm - 4000K 270 lm
- LED: HONGLITRONIC 2835 /(8+42 pz) 3 STEP MAC ADAM
- Batería de litio incluida: 18650 / 7500mA/H*3; para las instrucciones de sustitución de la batería consulte el sitio web www.zafferanoitalia.com. Para la sustitución se recomienda el uso de una batería original.
- Recarga standard: 1A - 2A (max 2,5A)
- Recarga: 5 h 2A - 10 h 1A
- Duración de la batería: 100% 8 h - 60% 13 h - 30% 28 h - 6% 58 h
- Clase: III
- Grado de protección: IP65
- CRI≥90
- En referencia a la norma UNI EN ISO 9227, la resistencia de la lampada a la exposición con niebla salina neutra (NSS) está garantizada durante 1500 horas.

3. Cargador de baterías:

- Para cargar el producto es posible usar el cargador de baterías USB estándar A.
- Cargador de batería con doble entrada USB – NO INCLUIDO: INPUT 100-240 V AC - 50/60Hz; OUTPUT DC 5V - 2.1 A.
- Para una carga correcta de la lámpara se aconseja: 1- conecte el cable USB al adaptador; 2- conecte el cable USB a la lámpara; 3- conecte el enchufe a la toma de corriente; 4- una vez completada la carga, retire el enchufe de la toma eléctrica y retire el cable USB.
- La lámpara funciona correctamente, aunque esté conectada a la corriente.
- Se aconseja el uso del cargador opcional y del cable en dotación original. Como alternativa, utilizar un cable y cargador de 2A certificados.

4. Configuración de fábrica:

- BRILLO 100% - K 2700 - LLAMADA A LA MESA OFF - OSCURECEDOR ON - FIJACIÓN MECÁNICA

5. Atención:

- La superficie de apoyo de la lámpara no debe superar los 15° de inclinación para evitar su caída.
- La batería se entrega con las siguientes protecciones: cortocircuito, sobredescarga, sobrecarga, sobrecorriente, sobretensión.
- Para preservar la integridad de la batería se aconseja mantener la carga entre un mínimo del 20% y un máximo del 80%; si la lámpara no se utiliza durante períodos prolongados se aconseja realizar periódicamente un ciclo de carga/descarga del producto.
- Remítase a las normativas de ley locales para una eliminación y reciclaje correctos de la batería.

Visite nuestro sitio web para más informaciones y actualizaciones sobre las características del producto

NO FABRICADO EN ITALIA - IMPORTADO POR

Zafferano srl, Viale dell'Industria, 26 - 31055 Quinto di Treviso - tv - Italia

www.zafferanoitalia.com



instrucciones de uso

CONFIGURACIÓN DE FÁBRICA

ENCENDIDO/ APAGADO

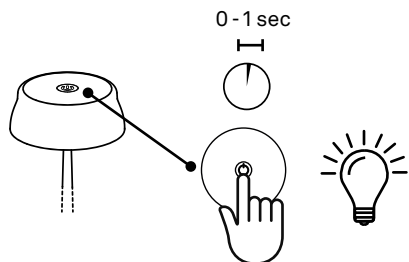

Toque rápido en la pantalla táctil para encender la lámpara

1

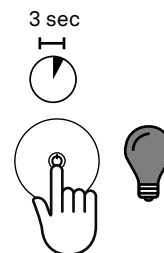

Ligera presión durante 3 segundos para apagar la lámpara

2

OSCURECIMIENTO

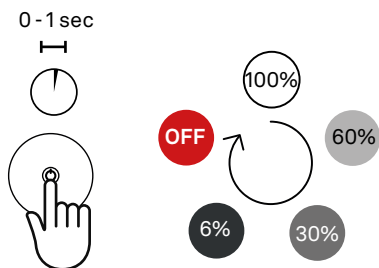

Con la lámpara encendida, toque rápido para cambiar el brillo del dispositivo. La repetición de las fases de la variación de la luz es cíclica.

OTRAS CONFIGURACIONES

LLAMADA A LA MESA (SE ON - nivel 4 configuración menú)

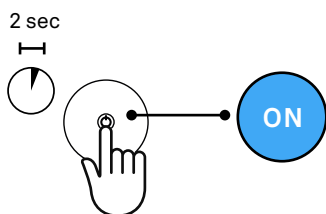

Con la lámpara encendida, ligera presión durante 2 segundos para activar la llamada a la mesa

1

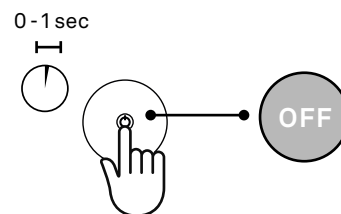

Toque rápido para desactivar la llamada a la mesa

2

ENCENDIDO/ APAGADO (SE DIMMER Y LLAMADA A LA MESA OFF - nivel 3 y 4 configuración menú)

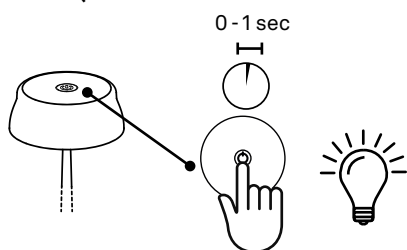

Toque rápido en la pantalla táctil para encender la lámpara

1

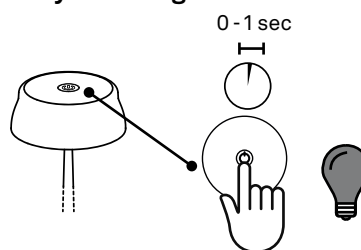

Toque rápido en la pantalla táctil para apagar la lámpara

2

LED DE SEÑALIZACIÓN

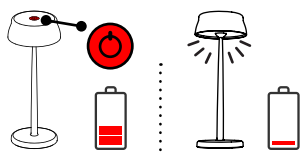

LED ROJO FIJO carga de la batería inferior al 20%, se recomienda recargar. Cuando la carga está agotada (1%), la lámpara no se enciende, sino que emite tres destellos blancos de alerta - recargar

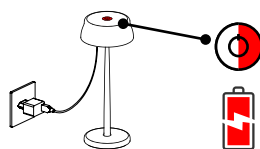

LED ROJO INTERMITENTE recarga en curso

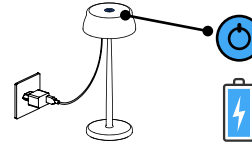

LED AZUL FIJO batería cargada al 100%, es aconsejable desconectar de la unidad de recarga

Visite nuestro sitio web para más informaciones y actualizaciones sobre las características del producto

NO FABRICADO EN ITALIA - IMPORTADO POR

Zafferano srl, Viale dell'Industria, 26 - 31055 Quinto di Treviso - tv - Italia

www.zafferanoitalia.com

configuración menú



El menú de configuración está formado por cuatro niveles consecutivos:

- 1) Configuración del brillo por defecto
- 2) Configuración de la temperatura de color
- 3) Oscurecimiento ON - OFF
- 4) Llamada a la mesa ON - OFF

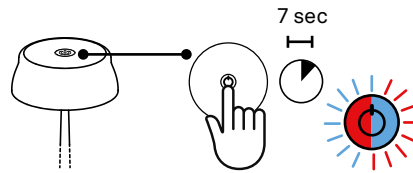

PARA ACCEDER AL MENÚ (primer nivel)
Con lámpara apagada, ligera presión durante 7 segundos hasta que no parpadee de color rojo/azul (durante 3 vueltas)

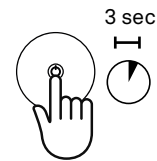

2b)* GUARDAR Y SALIR DEL MENÚ
Desde cualquier nivel, ligera presión durante 3 segundos para apagar la lámpara

0-1 sec

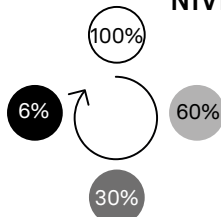
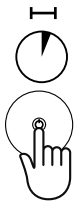

NIVEL 1 - BRILLO POR DEFECTO

1-2 sec

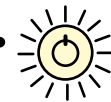

- 1) Toque rápido para cambiar el brillo de la lámpara

- 2) **GUARDAR Y PASAR AL NIVEL 2**
Ligera presión durante 1-2 segundos hasta que aparezca un destello
2b)*

0-1 sec

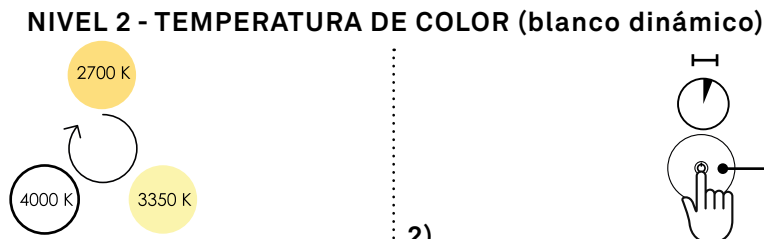
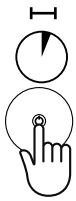

NIVEL 2 - TEMPERATURA DE COLOR (blanco dinámico)

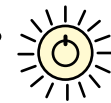

- 1) Toque rápido para cambiar la temperatura de color de la lámpara

- 2) **GUARDAR Y PASAR AL NIVEL 3**
Ligera presión durante 1-2 segundos hasta que aparezca un destello
2b)*

0-1 sec

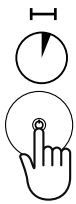

NIVEL 3 - OSCURECIMIENTO (LED ROJO)



- 1) Toque rápido para configurar el oscurecedor ON (LED rojo fijo) u OFF (LED rojo intermitente)

- 2) **GUARDAR Y PASAR AL NIVEL 4**
Ligera presión durante 1-2 segundos hasta que aparezca un destello
2b)*

0-1 sec

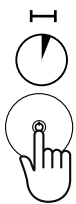

LIVELLO 4 - CHIAMATA AL TAVOLO (LED BLU)

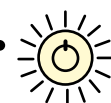

- 1) Toque rápido para configurar la llamada a la mesa ON (LED azul fijo) u OFF (LED azul intermitente)

- 2) **GUARDAR Y PASAR AL NIVEL 1**
Ligera presión durante 1-2 segundos hasta que aparezca un destello
2b)*

Visite nuestro sitio web para más informaciones y actualizaciones sobre las características del producto

NO FABRICADO EN ITALIA - IMPORTADO POR

Zafferano srl, Viale dell'Industria, 26 - 31055 Quinto di Treviso - tv - Italia

www.zafferanoitalia.com



restablecimiento de las configuraciones

Restablecimiento de la configuración de fábrica

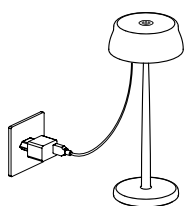

1

Conectar la lámpara a la toma de corriente

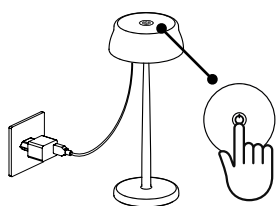

2

Apoyar el dedo en el elemento táctil manteniendo la presión

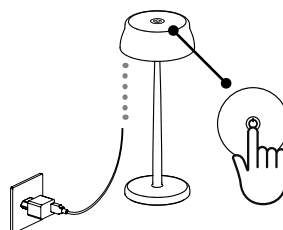

3

Desconectar la lámpara de la toma de corriente

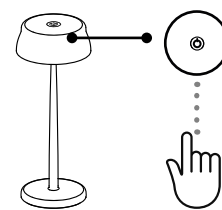

4

Levantar el dedo del elemento táctil

instrucciones de montaje

Fijación magnética

INCLUIDO



kit para fijación magnética

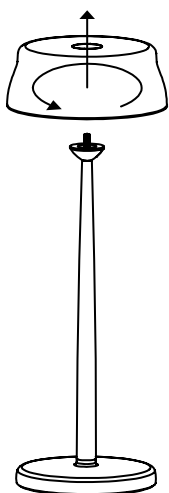

1

Desatornillar el cabezal de la lámpara del pasador roscado

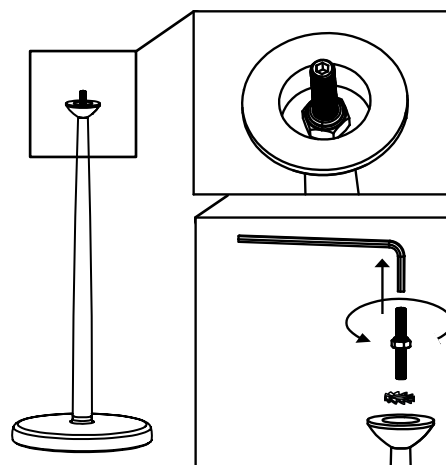

2

Desatornillar el perno roscado

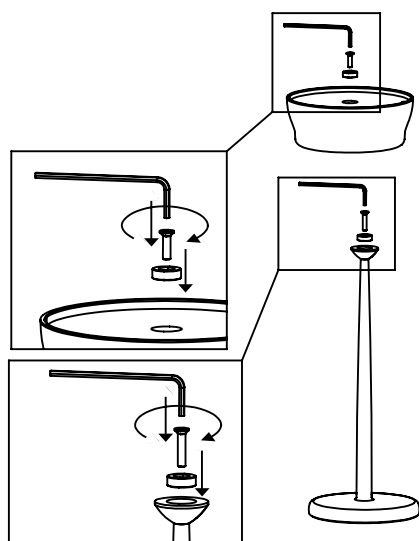

3

Atornillar los imanes

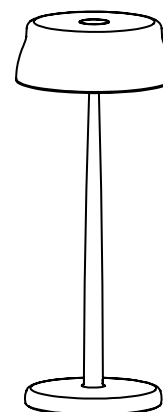

Visite nuestro sitio web para más informaciones y actualizaciones sobre las características del producto

NO FABRICADO EN ITALIA - IMPORTADO POR

Zafferano srl, Viale dell'Industria, 26 - 31055 Quinto di Treviso - tv - Italia

www.zafferanoitalia.com

zafferano

LAMPES A PORTER



Zafferano srl

Viale dell'Industria, 26
31055 - Quinto di Treviso - Italia
T +39 0422 470507
F +39 0422 470400
lighting@zafferanoitalia.com

C.F 03420190260 - P.IVA IT 03305480273
REA di TV n. 330102

www.zafferanoitalia.com