

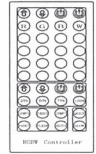

Art.-Nr.: **706.27**  
**706.28**

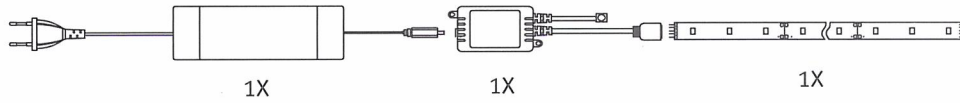

(+MA 326) PPN 02/18



1X

**A**

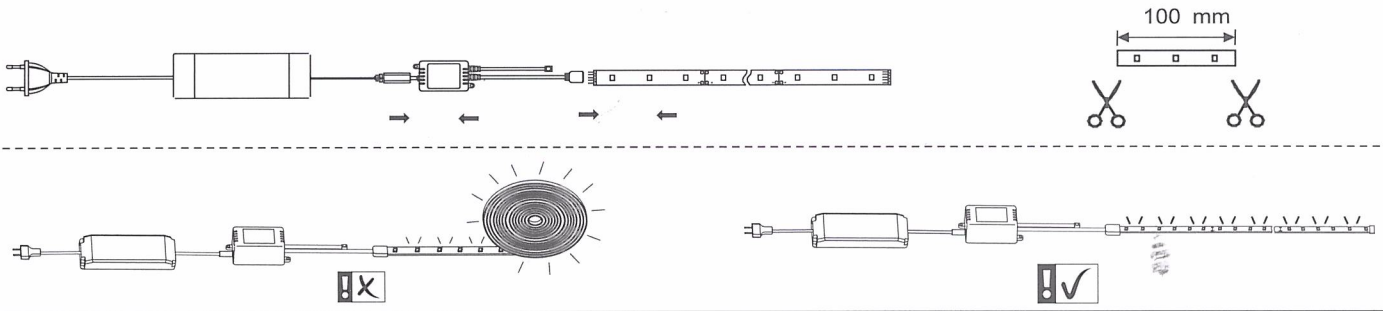

**B**

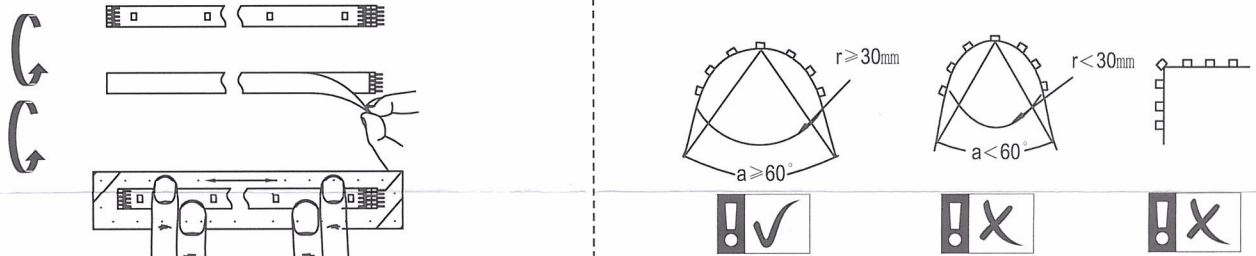

**C**

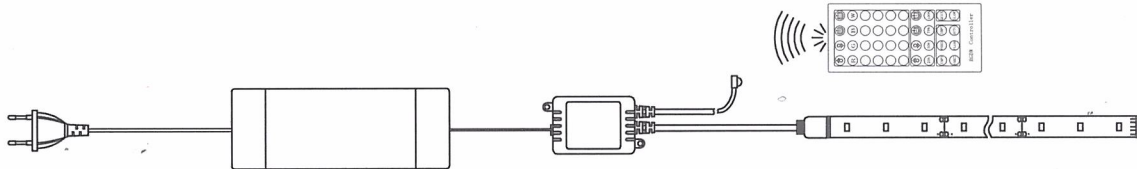

**D**

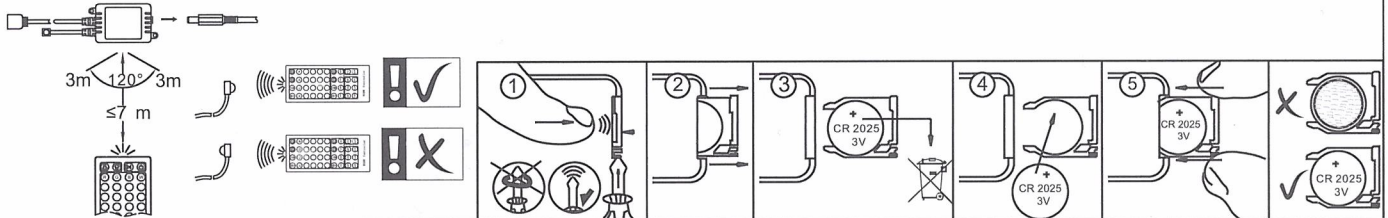

**E**

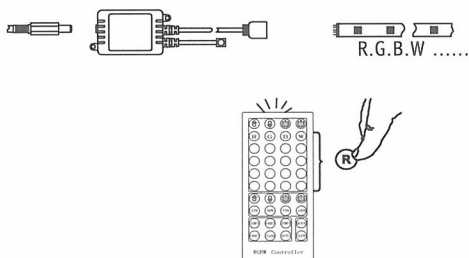

**F**

