

**10012688**

2,2W LED / 5W Total

incl. LED Board: L9003135

4400mah / 185650 3,7Vdc Li-ion battery / 5Vdc constant voltage / 1,0A

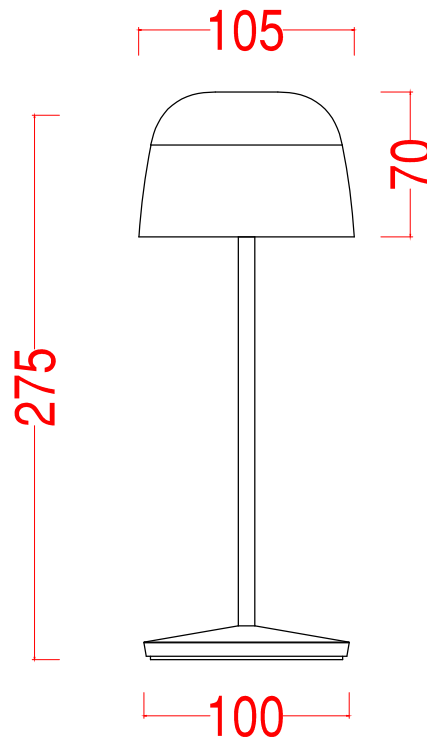



 Maßeinheit/Unit of measure/ Unité de mesure: **mm**

## (DE) Bestimmungsgemäße Verwendung

(EN) Intended use | (FR) Utilisation conforme | (NL) Beoogd gebruik | (PL) Stosowanie zgodnie z przeznaczeniem | (NO) Riktig bruk | (DK) Korrekt brug  
 (SE) Avsedd användning | (FI) Määräystenmukainen käyttö | (IT) Impiego appropriato | (ES) Uso prescrito | (CZ) Použití v souladu s určením  
 (PT) Utilização correta | (GR) Ενδεδειγμένη χρήση | (SK) Predpokladané použitie | (EE) Eeldatav kasutus | (LV) Paredzamais lietojums  
 (LT) Numatomas naudojimas | (RO) Utilizare intenționată | (SI) Predvidena uporaba | (HR) Namjenska upotreba | (HU) Tervezett felhasználás  
 (BG) предназначена употреба | (AL) Përdorimi i parashikuar | (MK) Предвидена употреба | (TR) Amaçlı kullanım | (UK) Призначене використання  
 (BA,ME,RS) Namjenska upotreba

|      |  |      |  |
|------|--|------|--|
| (DE) | Als Tischleuchte im Innenbereich               | (GB) | For use indoors as a table lamp                    |
| (FR) | En tant que lampe à poser, à l'intérieur       | (NL) | Als tafellamp binnenshuis                          |
| (PL) | Jako lampa stołowa do wnętrz                   | (NO) | Som bordlampe innendørs                            |
| (DK) | Som bordlampe indendørs                        | (SE) | Används som bordslampa inomhus                     |
| (FI) | Käyttö sisätilojen pöytävalaisimena            | (IT) | Impiego come lampada da tavolo in ambienti interni |
| (ES) | Empleo en tanto lámpara de mesa en interiores  | (CZ) | Použití jako stolní lampa v interiéru              |
| (PT) | Aplicação como candeeiro de mesa em interiores | (GR) | Χρήση ως επιτραπέζιο φωτιστικό σε εσωτερικό χώρο   |
| (SK) | Na použitie v interiéri ako stolová lampa      | (BG) | За използване на закрито като настолна лампа       |
| (EE) | kasutamiseks siseruumides lauualambina         | (LV) | Izmantošanai iekštelpās kā galda lampu             |
| (LT) | Naudoti patalpoje kaip stalinį šviestuvą       | (RO) | Pentru utilizare în interior ca lampă de masă      |
| (SI) | Za notranjo uporabo kot namizna svetilka       | (HR) | Za upotrebu u zatvorenom prostoru kao stolna lampa |
| (HU) | Beltéri használatra asztali lámpaként          | (AL) | Për përdorim brenda si llambë tavoline             |
| (MK) | За употреба внатре како масна ламба            | (TR) | Masa lambası olarak iç mekanda kullanım için       |
| (UK) | Для використання всередині як настільна лампа  | (BA) | Za upotrebu unutar kao stolna lampa                |
|      |  | (ME) |  |
|      |  | (RS) |  |

| (DE) Lieferumfang   |  |   |
|---|--|---|
| (EN) Package contents   (FR) Contenu de la livraison   (NL) Bij de levering inbegrepen   (PL) Zakres dostawy   (NO) Levering   (DK) Leveringsomfang<br>(SE) Leveransomfattning   (FI) Toimitussisältö   (IT) Fornitura   (ES) Volumen de suministro   (CZ) Rozsah dodávky   (PT) Material fornecido<br>(GR) Περιεχόμενα εξοπλισμού   (SK) Obsah balenia   (EE) Pakendi sisu   (LV) Pakas saturs   (LT) Pakuotės turinys<br>(RO) Conținutul pachetului   (SI) Vsebina paketa   (HR) Sadržaj paketa   (HU) A csomag tartalma   (BG) обхват на доставката<br>(AL) Përmbajtja e dorëzimit   (MK) Содржина на испорака   (TR) Teslimat içeriği   (UK) Зміст доставки   (BA,ME,RS) Sadržaj isporuke |  |   |
| (DE) 1 Tischleuchte<br>Montagematerial<br>Montageanleitung  | (GB) 1 Table lamp<br>Installation hardware<br>Mounting instructions            | (FR) 1 Lampe à poser<br>Matériel de montage<br>Instructions de montage        |
| (NL) 1 Tafellamp<br>Monteringsmateriale<br>Montagehandleiding   | (PL) 1 Lampa stołowa<br>Elementy montażowe<br>Instrukcja montażu               | (NO) 1 Bordlampe<br>Monteringsmateriale<br>Brukerveiledning                   |
| (DK) 1 Bordlampe<br>Monteringsmateriale<br>Brugervejledning   | (SE) 1 Bordslampa<br>Monteringsmaterial<br>Monteringsanvisning                 | (FI) 1 Pöytävalaisin<br>Asennusmateriaali<br>Asennusohjeet                    |
| (IT) 1 Lampada da tavolo<br>Materiale di montaggio<br>Istruzioni di montaggio   | (ES) 1 Lámpara de mesa<br>Material de montaje<br>Instrucciones de montaje      | (CZ) 1 Stolní lampa<br>Materiál pro montáž<br>Návod k montáži                 |
| (PT) 1 Candeeiro de mesa<br>Material de montagem<br>Instruções de montagem  | (GR) 1 Επιτραπέζιο φωτιστικό<br>Υλικό συναρμολόγησης<br>Οδηγίες συναρμολόγησης | (SK) 1 stolová lampa<br>Inštalacný hardvér<br>Inštalčná príručka              |
| (BG) 1 настолна лампа<br>материали за монтаж<br>инструкции за монтаж  | (EE) 1 laualamp<br>Paigaldustarvikud<br>Paigaldusjuhend                        | (LV) 1 galda lampa<br>Instalācijas aparatūra<br>Uzstādīšanas instrukcija      |
| (LT) 1 stalinis šviestuvus<br>Montavimo aparatinė įranga<br>Montavimo instrukcija   | (RO) 1 lampă de masă<br>Hardware de instalare<br>Instrucțiuni de montare       | (SI) 1 namizna svetilka<br>Namestitvena strojna oprema<br>Navodila za montažo |
| (HR) 1 Stolna lampa<br>Instalacijski hardver<br>Upute za montažu  | (HU) 1 asztali lámpa<br>Telepítési hardver<br>Szerezési útmutató               | (AL) 1 llambë tavoline<br>Materiali i montimit<br>Udhëzuesi i montimit        |
| (MK) 1 ламба за маса<br>Монтажен материјал<br>Упатство за монтажа   | (TR) 1 masa lambası<br>Montaj malzemesi<br>Montaj kılavuzu                     | (UK) 1 настільна лампа<br>Монтажний матеріал<br>Інструкція з монтажу          |
| (BA) 1 stolna lampa<br>(ME) Montažni materijal<br>(RS) Uputstvo za montažu  |  |   |

| (DE) Verwendete Symbole   |  |
|---|--|
| (EN) Safety Precautions   (FR) Symboles utilisés   (NL) Gebruikte symbolen   (PL) Stosowane symbole   (NO) Brukte symboler   (DK) Brugte symboler<br>(SE) Använda symboler   (FI) Käytetyt symbolit   (IT) Simboli usati   (ES) Símbolos empleados   (CZ) Použité symboly   (PT) Símbolos utilizados<br>(GR) Χρησιμοποιούμενα σύμβολα   (SK) Bezpečnostné opatrenia   (EE) Ohutusabinõud   (LV) Drošības pasākumi<br>(LT) Saugos priemonės   (RO) Măsuri de precauție   (SI) Varnostni ukrepi   (HR) Mjere opreza   (HU) Használt szimbólumok   (BG) Мерки за безопасност<br>(AL) Simbolet e përdorura   (MK) Користени симболи   (TR) Kullanılan semboller   (UK) Використовувані символи   (BA,ME,RS) Korišteni simboli |  |
| IP 65   |    |



## TOUCH ON/OFF

DE: Erinnerung an Helligkeit.

Jedes Mal, wenn Sie die Lampe einschalten, ist die Helligkeit der Beleuchtung dieselbe wie bei der vorherigen Einstellung.

GB: Memory of brightness.

Every time switch on the lamp, the lighting brightness is the same as the previous setting.

FR: Mémoire de la luminosité.

Jedes Mal, wenn Sie die Lampe einschalten, ist die Helligkeit der Beleuchtung dieselbe wie bei der vorherigen Einstellung.

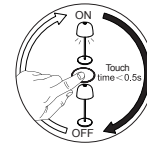
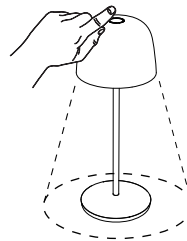

## STUFENLOSER DIMMER / STEPLESS DIMMER/ GRADATEUR PROGRESSIF

DE: Farbtemperatur: 3000K

GB: Color temperature: 3000K

FR: Température de couleur : 3000K



DE: FUNKTIONIERT NUR, WENN DAS LICHT EINGESCHALTET IST

GB: ONLY WORKS WHEN THE LIGHT IS ON

FR: NE FONCTIONNE QUE LORSQUE LA LUMIÈRE EST ALLUMÉE

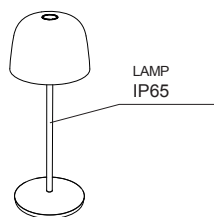
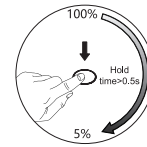
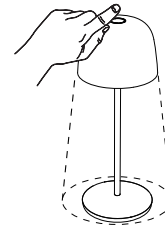
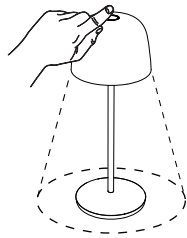

## CHARGE

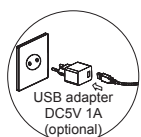

USB Type C

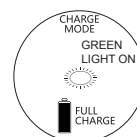
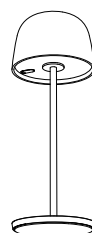
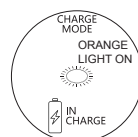
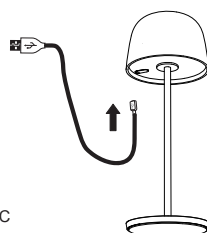

|   |   |                                 |
|---|---|---------------------------------|
| <p>(DE) Dieses Produkt enthält eine Lichtquelle der Energieeffizienzklasse F<br/> (EN) This product contains a light source of energy efficiency class F<br/> (FR) Ce produit comprend une source de lumière de classe d'efficience énergétique F<br/> (NL) Dit product bevat een lichtbron van energie-efficiëntieklasse F<br/> (PL) Produkt ten zawiera źródło światła o klasie efektywności energetycznej F<br/> (NO) Dette produktet inneholder en lyskilde i energieffektivitetsklasse F<br/> (DK) Dette produkt indeholder en lyskilde af energieeffektklasse F<br/> (SE) Denna produkt innehåller en ljuskälla i energieffektivitetsklass F<br/> (FI) Tämä tuote sisältää energiatehokkuusluokan F valonlähteen<br/> (IT) Questo prodotto contiene una sorgente luminosa della classe di efficienza energetica F<br/> (ES) Este producto contiene una fuente de luz de la clase de eficiencia energética F<br/> (CZ) Tento výrobek obsahuje světelný zdroj třídy energetické účinnosti F<br/> (PT) Este produto contém uma fonte de luz da classe de eficiência energética F<br/> (GR) Αυτό το προϊόν περιέχει μια φωτεινή πηγή ενεργειακής απόδοσης κλάσης F<br/> (SK) Tento výrobok obsahuje zdroj svetla triedy energetickej efektivity F<br/> (EE) See toode sisaldab energiatõhususklassi F valgusallikat<br/> (LV) Šis produkts satur enerģijas efektivitātes klases F gaismas avotu<br/> (LT) Šis gaminys turi energijos efektyvumo klasės F šviesos šaltinį<br/> (RO) Acest produs conține o sursă de lumină de clasă de eficiență energetică F<br/> (SI) Ta izdelek vsebuje svetlobni vir energijskega razreda F<br/> (HR) Ovaj proizvod sadrži izvor svjetlosti energetske učinkovitosti klase F<br/> (HU) Ez a termék egy F energiahatékonysági osztályú fényforrást tartalmaz<br/> (BG) Този продукт съдържа източник на светлина с клас на енергийна ефективност: F<br/> (AL) Ky produkt përmban një burim drite të klasës së efikasitetit të energjisë F<br/> (MK) Ovoj proizvod sadrži izvor na svetlina od klasa na energetska efikasnost F<br/> (TR) Bu ürün, enerji verimliliği sınıfı F olan bir ışık kaynağı içerir<br/> (UK) Цей продукт містить джерело світла класу енергоефективності F<br/> (BA)(ME)(RS) Ovaj proizvod sadrži izvor svjetlosti energetske klase F</p> | <p>QR</p>  | <p>EAN</p> <p>4251911798050</p> |
|---|---|---------------------------------|

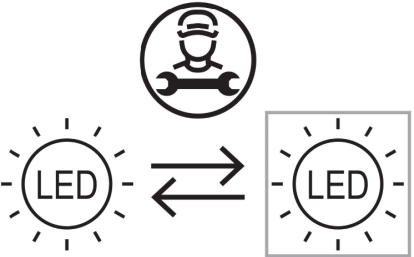
|   |  |
|---|--|
|  | <p>(DE) Durch einen Fachmann austauschbare Lichtquelle (nur LED).<br/> (EN) Replaceable (LED only) light source by a professional.<br/> (FR) Source de lumière remplaçable (LED uniquement) par un professionnel.<br/> (NL) Lichtbron (alleen led) te vervangen door een professional.<br/> (PL) Wymienne (tylko LED) źródło światła wykonane przez profesjonalistę.<br/> (NO) Utskiftbar (kun LED) lyskilde av en profesjonell.<br/> (DK) Udskiftelig lyskilde (kun LED), udskiftes af en elektriker.<br/> (SE) Ljuskälla (endast LED) utbytbar genom fackman.<br/> (FI) Ammatilainen voi vaihtaa vaihdettavan (vain LED) valonlähteen.<br/> (IT) Sorgente luminosa (solo LED) sostituibile da un professionista.<br/> (ES) Fuente de luz (solo LED) sustituible por un profesional.<br/> (CZ) Vyměnitelný (pouze LED) světelný zdroj odborníkem.<br/> (PT) Luz LED (apenas LED) substituível por um profissional.<br/> (GR) Η πηγή φωτός (μόνο LED) να αντικαθίσταται από επαγγελματία.<br/> (SK) Zdroj svetla (iba LED) vymeniteľný prostredníctvom odborníka.<br/> (EE) Spetsialisti poolt vahetatav valgusallikas (ainult LED).<br/> (LV) Speciālista maināms gaismas avots (tikai LED).<br/> (LT) Specialisto keičiamas šviesos šaltinis (tik LED).<br/> (RO) Sursă de lumină schimbabilă de către un specialist (doar LED).<br/> (SI) Svetlobni vir, ki ga lahko zamenja strokovnjak (samo LED).<br/> (HR) Izvor svjetlosti koji može zamijeniti stručnjak (samo LED).<br/> (HU) Szakember által cserélhető (csak LED) fényforrás.<br/> (BG) Светлинен източник, който може да се смени от специалист (само LED).<br/> (AL) Burim drite i zëvendësueshëm (LED vetëm) nga një profesionist.<br/> (MK) Izvorot na svetlina (samo LED) se zamenjuje od profesionalac.<br/> (TR) Değiştirilebilir (yalnızca LED) ışık kaynağı bir profesyonel tarafından değiştirilir.<br/> (UK) Замінний (тільки LED) джерело світла замінюється фахівцем.<br/> (BA)(ME)(RS) Zamjenjiv (samo LED) izvor svjetlosti zamjenjuje profesionalac.</p> |
|---|--|

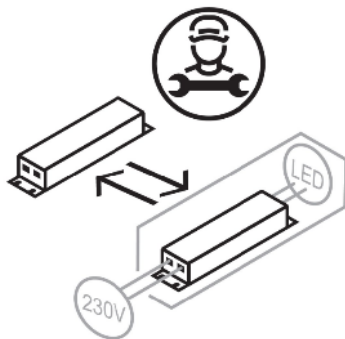

- (DE) Durch einen Fachmann austauschbares Betriebsgerät.  
 (EN) Replaceable control gear by a professional.  
 (FR) Contrôleur remplaçable par un professionnel.  
 (NL) Voorschakelapparatuur te vervangen door een professional.  
 (PL) Wymienny układ sterujący przez profesjonalistę.  
 (NO) Utskiftbar kontrollutstyr av en profesjonell.  
 (DK) Udskiftelig igangsætter, udskiftes af en elektriker.  
 (SE) Styrdon utbytbar genom fackman.  
 (FI) Ammattilainen voi vaihtaa vaihdettavat ohjauslaitteet.  
 (IT) Dispositivo di controllo sostituibile da un professionista.  
 (ES) Dispositivo de control sustituible por un profesional.  
 (CZ) Vyměnitelný předřadník odborníkem.  
 (PT) Dispositivo de controlo substituível por um profissional.  
 (GR) Ο εξοπλισμός ελέγχου να αντικαθίσταται από επαγγελματία.  
 (SK) Predradník vymeniteľný prostredníctvom odborníka.  
 (EE) Spetsialisti poolt vahetatav juhtseade.  
 (LV) Speciālista maināma vadības iekārta.  
 (LT) Specialisto keičiamas valdymo įrenginys.  
 (RO) Aparat de comandă schimbabil de către un specialist.  
 (SI) Nadomestna krmilna naprava, ki jo lahko zamenja strokovnjak.  
 (HR) Zamjenjivi upravljački sklop koji može zamijeniti stručnjak.  
 (HU) Szakember által cserélhető vezérlőszerkezet.  
 (BG) Уред, който може да се смени от специалист.  
 (AL) Pajisje kontrolli e zëvendësueshme nga një profesionist.  
 (MK) Заменлива контролна опрема од страна на професионалец.  
 (TR) Profesyonel tarafından değiştirilebilir kontrol donanımı.  
 (UK) Замінний контрольний пристрій фахівцем.  
 (BA)(ME)(RS) Zamjenjiva kontrolna oprema od strane profesionalca.