



Paulmann

# IP44



Info

[www.paulmann.com](http://www.paulmann.com)

Paulmann Licht GmbH  
Quezinger Feld 2  
31832 Springe  
Germany

[www.paulmann.com](http://www.paulmann.com)

Art.-Nr.: 501.37

PSRC 07/22



Li-MnO<sub>2</sub>  
1x CR2450

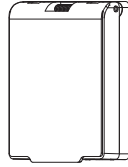

1x

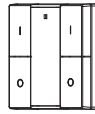

1x

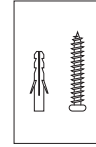

Incl.

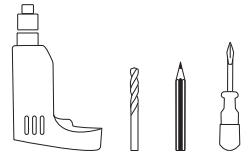

	Group A	<b>a1</b>	Click	On	Hold	Dimming +
		<b>a0</b>	Click	Off	Hold	Dimming -
	Group B	<b>b1</b>	Click	On	Hold	Dimming +
		<b>b0</b>	Click	Off	Hold	Dimming -
	Indicator	<b>c</b>		Blinking		Constant On

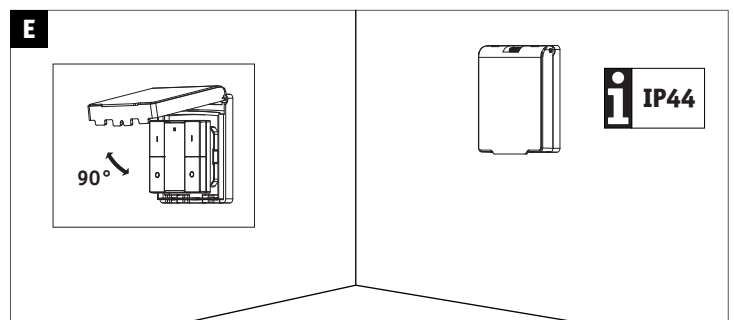
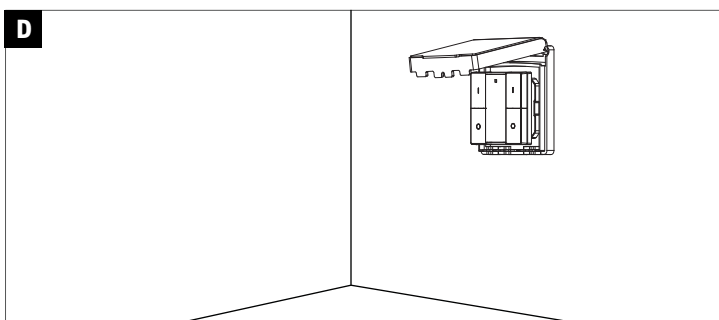
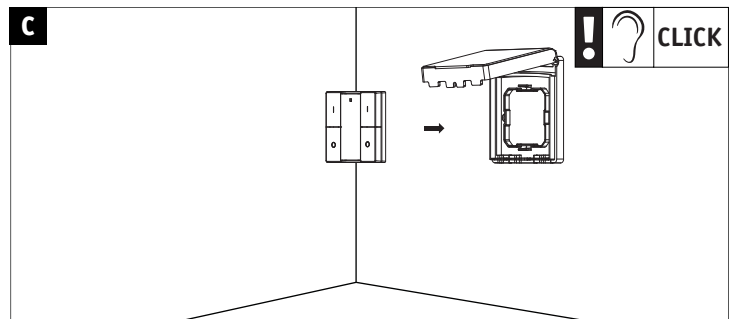
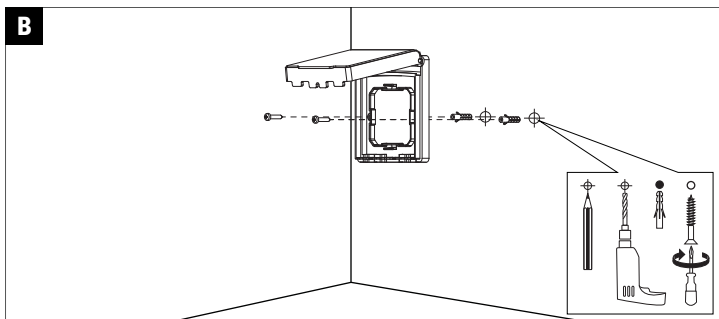
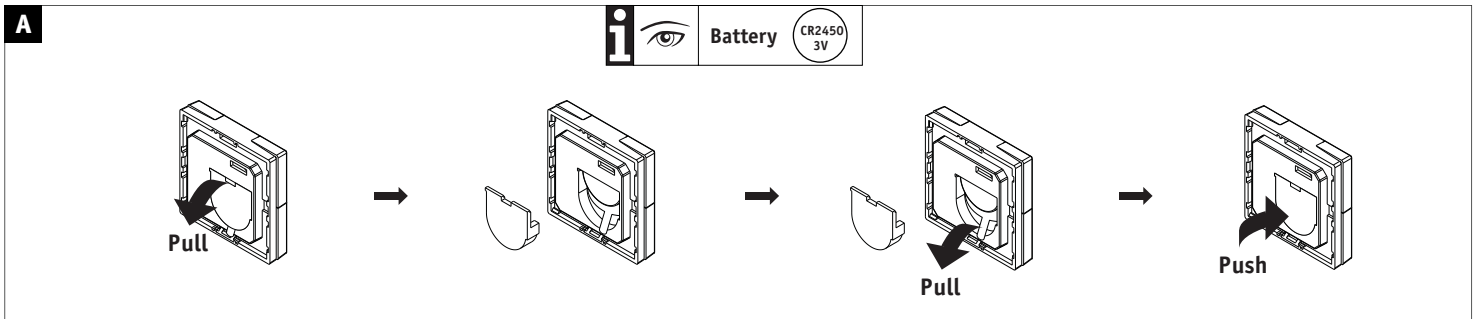

**without Gateway**

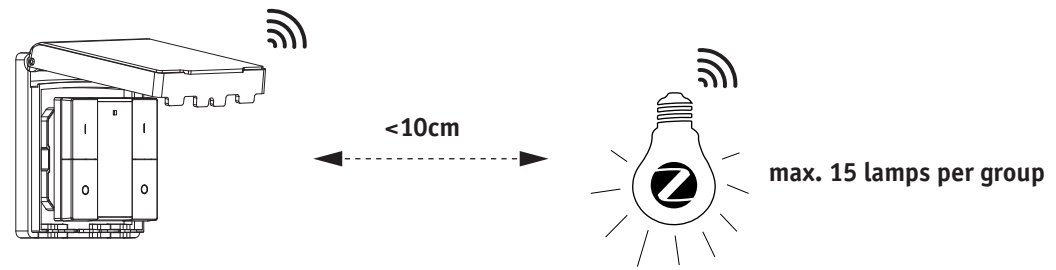

<p><b>Touchlink Connect</b></p>	<p><b>a1</b> Click Group A</p> <p>or</p> <p><b>b1</b> Click Group B</p>	<p>&lt;1 sec</p>	<p><b>a1 + b1</b> Hold</p>	<p>&lt;1 sec</p>	<p><b>a0</b> Click</p> <p>→ 3 sec → 6x</p>
<p><b>Touchlink Remove</b></p>	<p><b>a1</b> Click Group A</p> <p>or</p> <p><b>b1</b> Click Group B</p>	<p>&lt;1 sec</p>	<p><b>a1 + b1</b> Hold</p>	<p>&lt;1 sec</p>	<p><b>a0</b> Click 2x &lt;1 sec</p> <p>→ 3 sec → 6x</p>

**with Gateway**

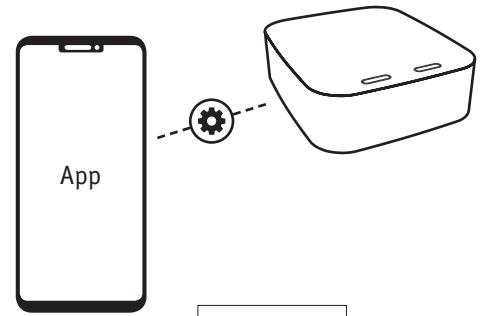
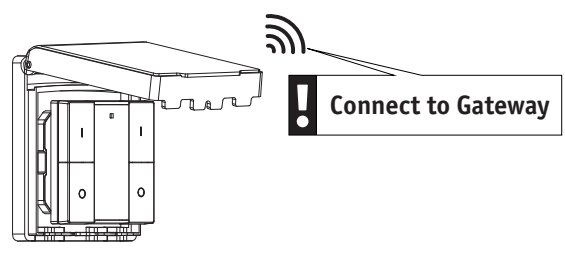

Learn more:  
[www.paulmann.com/zb](http://www.paulmann.com/zb)

<p><b>Ready for Gateway</b></p>	<p><b>Factory Reset</b></p>	<p><b>a0 + b0</b> Click 3x &lt;2 sec</p> <p>→ 20 sec</p>
---------------------------------	-----------------------------	--

**Factory Reset**

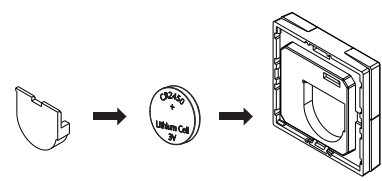
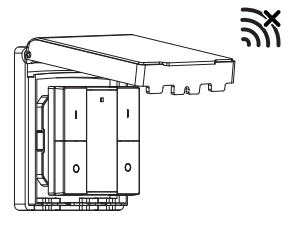

1x Li-MnO<sub>2</sub> Battery (3V 620mAh)

<p><b>Factory Reset</b></p>	<p><b>a0 + b0</b> Click 3x &lt;2 sec</p> <p>→ 3x</p>
-----------------------------	--

Zugelassen für den Betrieb in allen Ländern der EU / Approved for operating in all European countries  
CE: Konform mit / in accordance with / conforme-ment a 2014/53/EU <http://www.paulmann.com/ce>

2,4 GHz – 2,4835 GHz



Doesn't apply for the geographical area within a radius of 20km from the centre on "Ny Alesund"

Hiermit erklärt Paulmann Licht, dass der Funkanlagentyp [501.37] der Richtlinie 2014/53/EU entspricht.  
Der vollständige Text der EU-Konformitätserklärung ist unter der folgenden Internetadresse verfügbar: [www.paulmann.com/ce](http://www.paulmann.com/ce)  
Funk-Frequenz [2,4 GHz – 2,4835 GHz] Abgestrahlte Energie [10 mW]

= D Altgeräte dürfen nicht in den Restmüll. Sie können bei öffentlichen Sammelstellen von Entsorgungsträgern abgegeben werden. Altbatterien und Altkumulatoren, sowie Lampen, die zerstörungsfrei aus dem Altgerät entnommen werden können, sind vor der Abgabe an eine Erfassungsstelle von dem Altgerät zu trennen. Vertreiber sind im Rahmen von § 17 Absatz 1 und 2 ElektroG zur unentgeltlichen Rücknahme dieses Produktes verpflichtet. Endnutzer von Altgeräten müssen eigenverantwortlich für die Löschung personenbezogener Daten auf den zu entsorgenden Altgeräten sorgen.  
[www.paulmann.com](http://www.paulmann.com)