

# Calle, Perennial *Elegance.*

design Draw  
terzani.com

**TERZANI**  
LA LUCE PENSATA



**Type |**  
Pendant

**Materials |**  
Clear crystal (24% lead)

**Finishes | Code**



White disc/Clear  
OT01S E8 A9 KK

White canopy

Body |

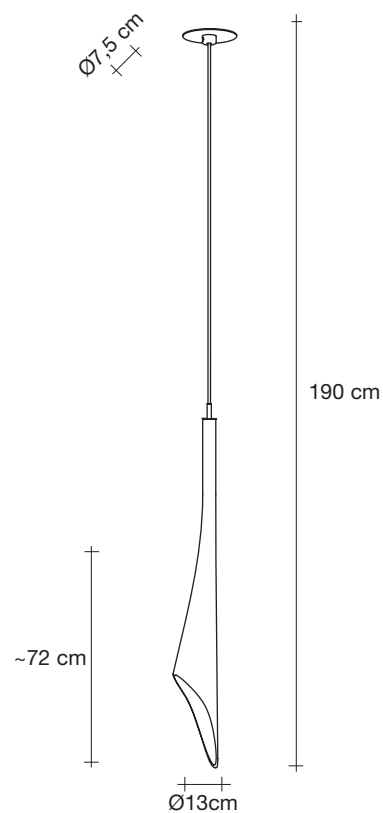

**Recommended Light | Disc |**

230-240V ~ 50/60Hz



HALOGEN  
20W G4 12V



Dimmable with IGBT  
Dali system on request

or on request



LED  
2W G4 12V



Not Dimmable  
Dali system on request

1,4 cm



Ø7,5 cm

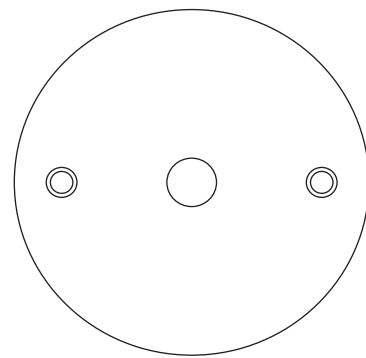

3



1,5



83cm x 25cm x 26cm

# Calle, Perennial *Elegance.*

design Draw  
terzani.com



**Type |**  
Pendant

**Materials |**  
Clear crystal (24% lead)

**Finishes | Code**

 Clear  
OT01S E8 A9

White canopy

Body |

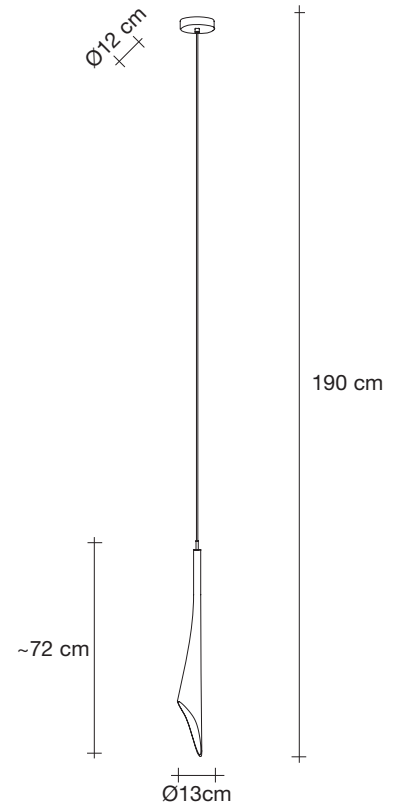

**Recommended Light | Canopy |**

230-240V ~ 50/60Hz

 HALOGEN  
20W G4 12V

 Dimmable with IGBT  
Dali system on request

or on request

 LED  
2W G4 12V

 Not Dimmable  
Dali system on request

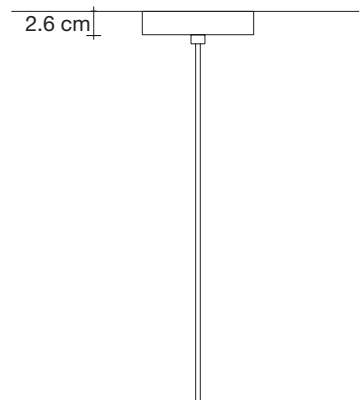
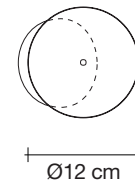

At Terzani, we spend countless days searching the globe for talented new designers, but sometimes they find us. Such is the case with the young designers Luca Martorano and Mattia Albicini who approached us with the design for Calle, a fantastic new light we instantly fell in love with. It showcases our skill at crafting crystal to take the material to an exciting, modern place. Luca and Mattia worked with our craftsmen to create a slender inverted flute of 24% lead crystal that, like the calla lily it mimics, can be grouped into stunning bouquets of light. Design Luca Martorano and Mattia Albicini.



# Calle, Perennial *Elegance.*

design Draw  
terzani.com

**TERZANI**  
LA LUCE PENSATA



**Type |**  
Pendant

**Materials |**  
Clear crystal (24% lead)

**Finishes | Code**

 Clear  
OT03S E8 A9

White canopy

Body |

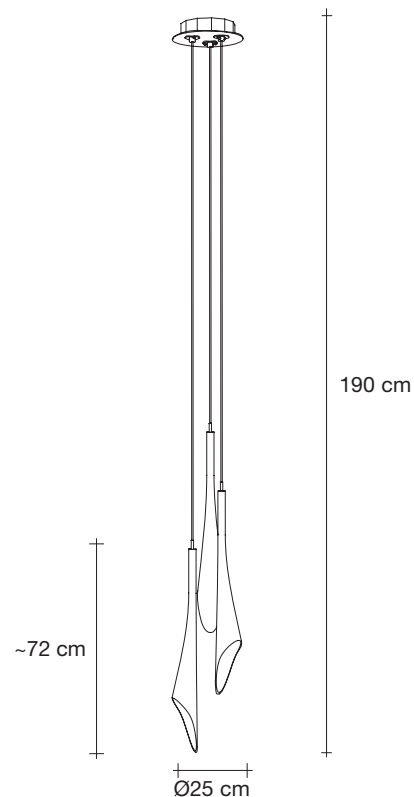

**Recommended Light | Canopy |**

**230-240V ~ 50/60Hz**

 HALOGEN  
3 x 20W G4 12V

 Dimmable with IGBT and TRIAC  
Dali system on request

**or on request**

 LED  
3 x 2W G4 12V

 Dimmable with IGBT  
Dali system on request

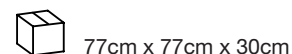
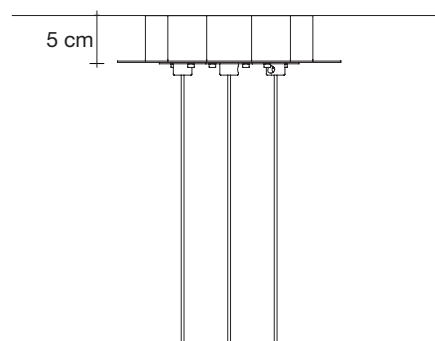
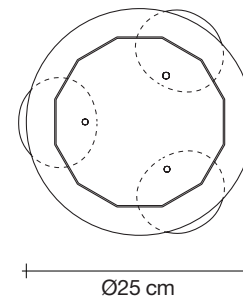

# Calle, Perennial *Elegance.*

design Draw  
terzani.com



**Type |**  
Pendant

**Materials |**  
Clear crystal (24% lead)

**Finishes | Code**

 Clear  
OT03S E8 A9 R

White canopy

Body |

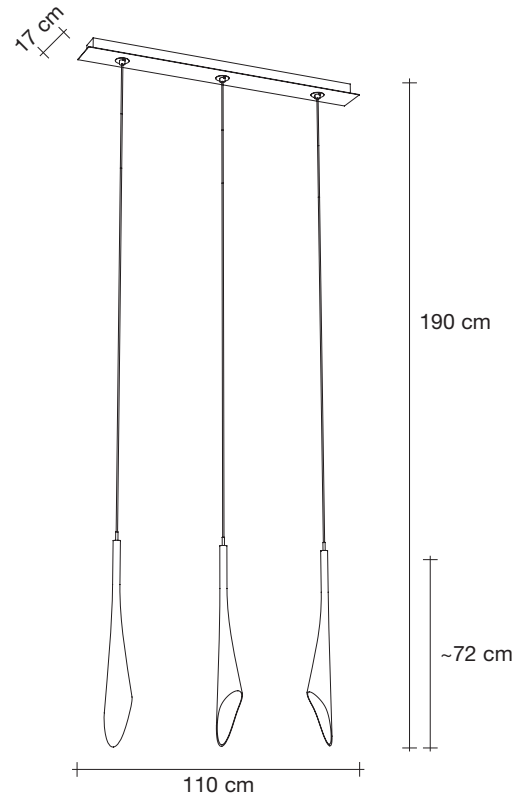

**Recommended Light | Canopy |**

**230-240V ~ 50/60Hz**

 HALOGEN  
3 x 20W G4 12V

 Dimmable with IGBT and TRIAC  
Dali system on request

**or on request**

 LED  
3 x 2W G4 12V

 Dimmable with IGBT  
Dali system on request

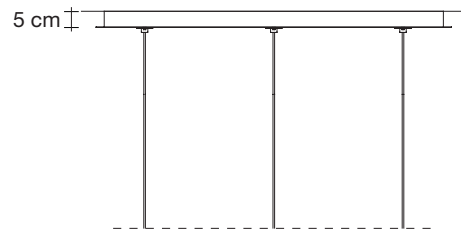
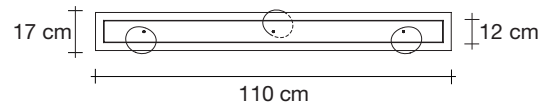

At Terzani, we spend countless days searching the globe for talented new designers, but sometimes they find us. Such is the case with the young designers Luca Martorano and Mattia Albicini who approached us with the design for Calle, a fantastic new light we instantly fell in love with. It showcases our skill at crafting crystal to take the material to an exciting, modern place. Luca and Mattia worked with our craftsmen to create a slender inverted flute of 24% lead crystal that, like the calla lily it mimics, can be grouped into stunning bouquets of light. Design Luca Martorano and Mattia Albicini.

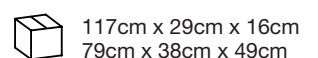

# Calle, Perennial *Elegance.*

design Draw  
terzani.com

**TERZANI**  
LA LUCE PENSATA



**Type |**  
Pendant

**Materials |**  
Clear crystal (24% lead)

**Finishes | Code**

 Clear  
OT05S E8 A9

White canopy

Body |

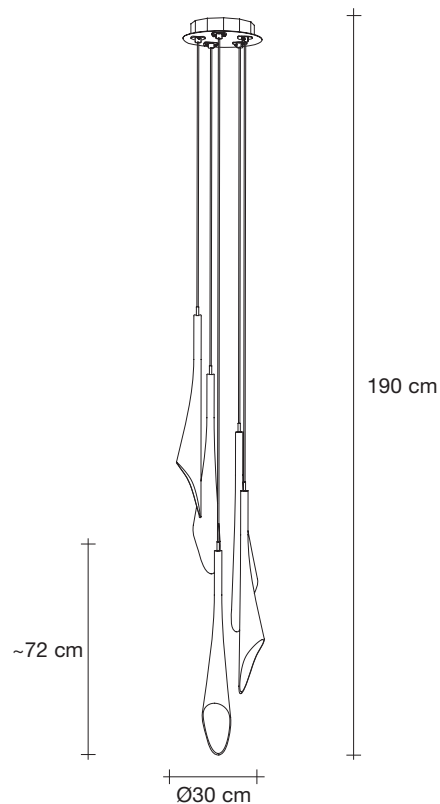

**Recommended Light | Canopy |**

**230-240V ~ 50/60Hz**

 HALOGEN  
5 x 20W G4 12V

 Dimmable with IGBT and TRIAC  
Dali system on request

**or on request**

 LED  
5 x 2W G4 12V

 Dimmable with IGBT  
Dali system on request

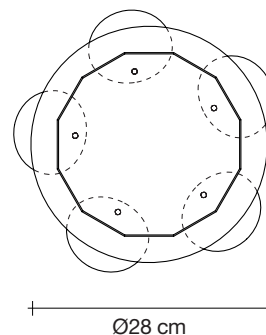

At Terzani, we spend countless days searching the globe for talented new designers, but sometimes they find us. Such is the case with the young designers Luca Martorano and Mattia Albicini who approached us with the design for Calle, a fantastic new light we instantly fell in love with. It showcases our skill at crafting crystal to take the material to an exciting, modern place. Luca and Mattia worked with our craftsmen to create a slender inverted flute of 24% lead crystal that, like the calla lily it mimics, can be grouped into stunning bouquets of light. Design Luca Martorano and Mattia Albicini.

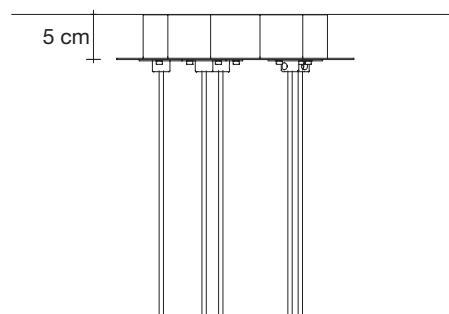

14



8,5



83cm x 80cm x 43,5cm

# Calle, Perennial *Elegance.*

design Draw  
terzani.com



**Type |**  
Pendant

**Materials |**  
Clear crystal (24% lead)

**Finishes | Code**

 Clear  
OT05S E8 A9 R

White canopy

Body |

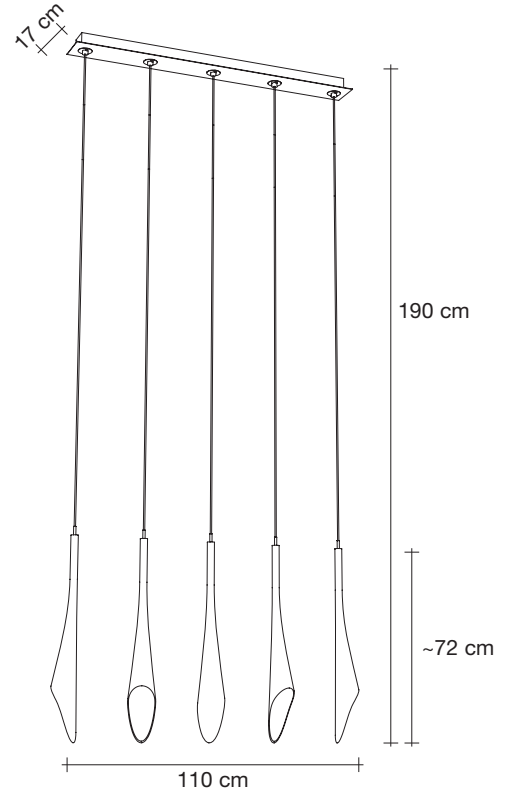

## Recommended Light | Canopy |

230-240V ~ 50/60Hz

 HALOGEN  
5 x 20W G4 12V

 Dimmable with IGBT and TRIAC  
Dali system on request

or on request

 LED  
5 x 2W G4 12V

 Dimmable with IGBT  
Dali system on request

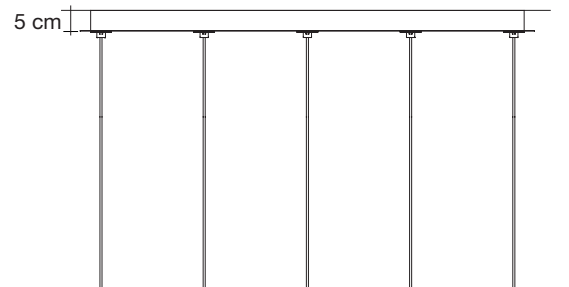
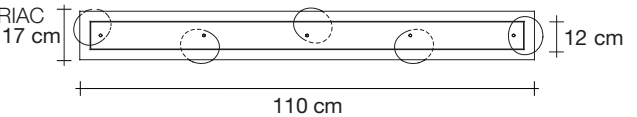

At Terzani, we spend countless days searching the globe for talented new designers, but sometimes they find us. Such is the case with the young designers Luca Martorano and Mattia Albicini who approached us with the design for Calle, a fantastic new light we instantly fell in love with. It showcases our skill at crafting crystal to take the material to an exciting, modern place. Luca and Mattia worked with our craftsmen to create a slender inverted flute of 24% lead crystal that, like the calla lily it mimics, can be grouped into stunning bouquets of light. Design Luca Martorano and Mattia Albicini.

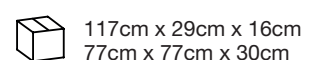
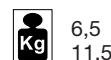

# Calle, Perennial *Elegance.*

design Draw  
terzani.com



**Type |**  
Pendant

**Materials |**  
Clear crystal (24% lead)

**Finishes | Code**



Clear  
OT35S E8 A9

White canopy

Body |

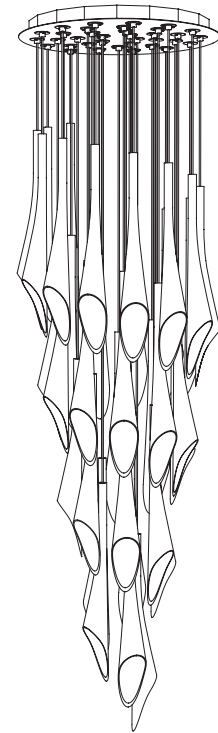

250 cm

Ø70 cm



**Recommended Light | Canopy |**

230-240V ~ 50/60Hz



HALOGEN  
35 x 10W G4 12V



Dimmable with IGBT and TRIAC  
Dali system on request

or on request



LED  
35 x 1.2W G4 12V



Dimmable with IGBT  
Dali system on request

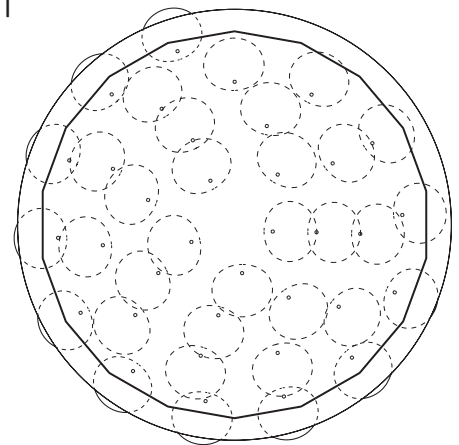

Ø70 cm

5 cm

At Terzani, we spend countless days searching the globe for talented new designers, but sometimes they find us. Such is the case with the young designers Luca Martorano and Mattia Albicini who approached us with the design for Calle, a fantastic new light we instantly fell in love with. It showcases our skill at crafting crystal to take the material to an exciting, modern place. Luca and Mattia worked with our craftsmen to create a slender inverted flute of 24% lead crystal that, like the calla lily it mimics, can be grouped into stunning bouquets of light. Design Luca Martorano and Mattia Albicini.



27  
54



21  
42



2x 77cm x 77cm x 30cm  
3x 83cm x 80cm x 43,5cm