

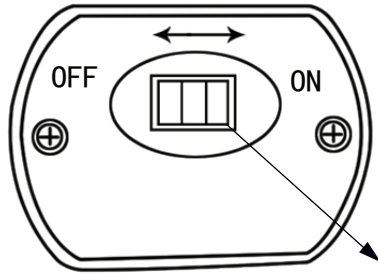

Art.no 481-99-45

FIRST USE

STEP 1.



(ON )

STEP 2.



(ON )



(OFF )



Ready after
36 h in the sun

BATTERY REPLACEMENT

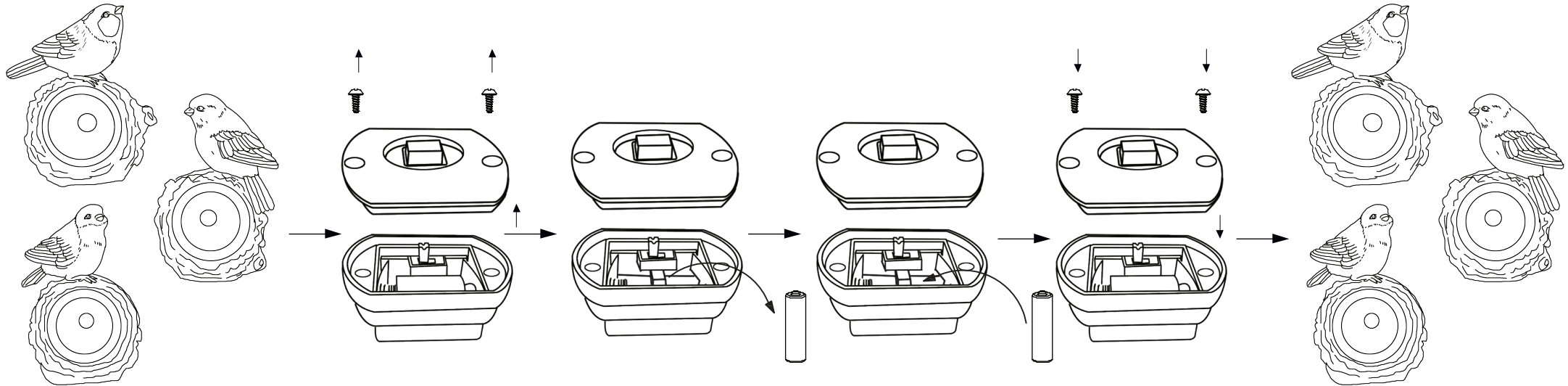

STAR[®]
TRADING

STAR STREET 1
512 50 SVENLJUNGA
SWEDEN

www.startrading.com