

9945245

 4,2W LED
 incl. LED Board: L9001095
 230V~ 50Hz

(DE) Bestimmungsgemäße Verwendung

 (GB) Intended use / (FR) Utilisation conforme / (NL) Beoogd gebruik / (PL) Stosowanie zgodnie z przeznaczeniem /
 (NO) Riktig bruk / (DK) Korrekt brug / (SE) Avsedd användning / (FI) Määräystenmukainen käyttö
 (IT) Impiego appropriato / (ES) Uso prescrito / (CZ) Použití v souladu s určením / (PT) Utilização correta / (GR) Ενδεικτική χρήση

(DE) Ortsfeste Verwendung als Wandleuchte im Außenbereich	(GB) Provided for stationary use on walls, outdoors
(FR) Installation fixe en tant qu'applique extérieure	(NL) Vast gebruik als wandlamp buitenshuis
(PL) Do montażu stacjonarnego jako lampa ścienna na zewnątrz	(NO) Til stasjonært bruk som vegglampe utendørs
(DK) Til stationær brug som væglampe udendørs	(SE) Används som fast väggampa utomhus
(FI) Kiinteä käyttö ulkotilojen seinävalaisimena	(IT) Impiego fisso come applique in ambienti esterni
(ES) Empleo fijo en tanto lámpara de pared en el exterior	(CZ) Stacionární použití jako nástěnné svítidlo v exteriéru
(PT) Aplicação fixa como luminária de parede em exteriores	(GR) Σταθερή χρήση ως φωτιστικό τοίχου σε εξωτερικό χώρο

(DE) Verwendete Symbole

 (GB) Safety Precautions / (FR) Symboles utilises / (NL) Gebruikte symbolen / (PL) Stosowane symbole / (NO) Brukte symboler /
 (DK) Brugte symboler / (SE) Använda symboler / (FI) Käytetyt symbolit / (IT) Simboli usati / (ES) Símbolos empleados /
 (CZ) Použité symboly / (PT) Símbolos utilizados / (GR) Χρησιμοποιούμενα σύμβολα

IP 44

(DE) Lieferumfang

 (GB) Package contents / (FR) Contenu de la livraison / (NL) Bij de levering inbegrepen / (PL) Zakres dostawy / (NO) Levering /
 (DK) Leveringsomfang / (SE) Leveransomfattning / (FI) Toimitussisältö / (IT) Fornitura / (ES) Volumen de suministro /
 (CZ) Rozsah dodávky / (PT) Material fornecido / (GR) Παραδοτέος εξοπλισμός

(DE) 1 Wandleuchte Montagematerial Montageanleitung	(GB) 1 Wall light Installation hardware Mounting instructions	(FR) 1 Applique Matériel de montage Instructions de montage
(NL) 1 Wandlamp Monteringsmateriale Montagehandleiding	(PL) 1 Lampa ścienna Elementy montażowe Instrukcja montażu	(NO) 1 Vegglampe Monteringsmateriale Brukerveiledning
(DK) 1 Væglampe Monteringsmateriale Brugervejledning	(SE) 1 Væglampa Monteringsmaterial Monteringsanvisning	(FI) 1 Seinävalaisin Asennusmateriaali Asennusohjeet
(IT) 1 Applique Materiale di montaggio Istruzioni di montaggio	(ES) 1 Lámpara de pared Material de montaje Instrucciones de montaje	(CZ) 1 Nástěnné svítidlo Materiál pro montáž Návod k montáži
(PT) 1 Luminária de parede Material de montagem Instruções de montagem	(GR) 1 Φωτιστικό τοίχου Υλικά συναρμολόγησης Οδηγίες συναρμολόγησης	

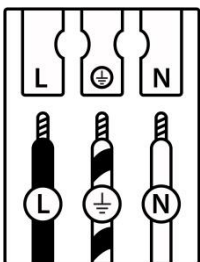
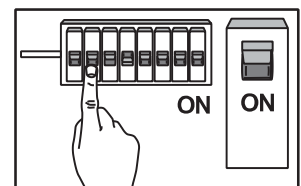
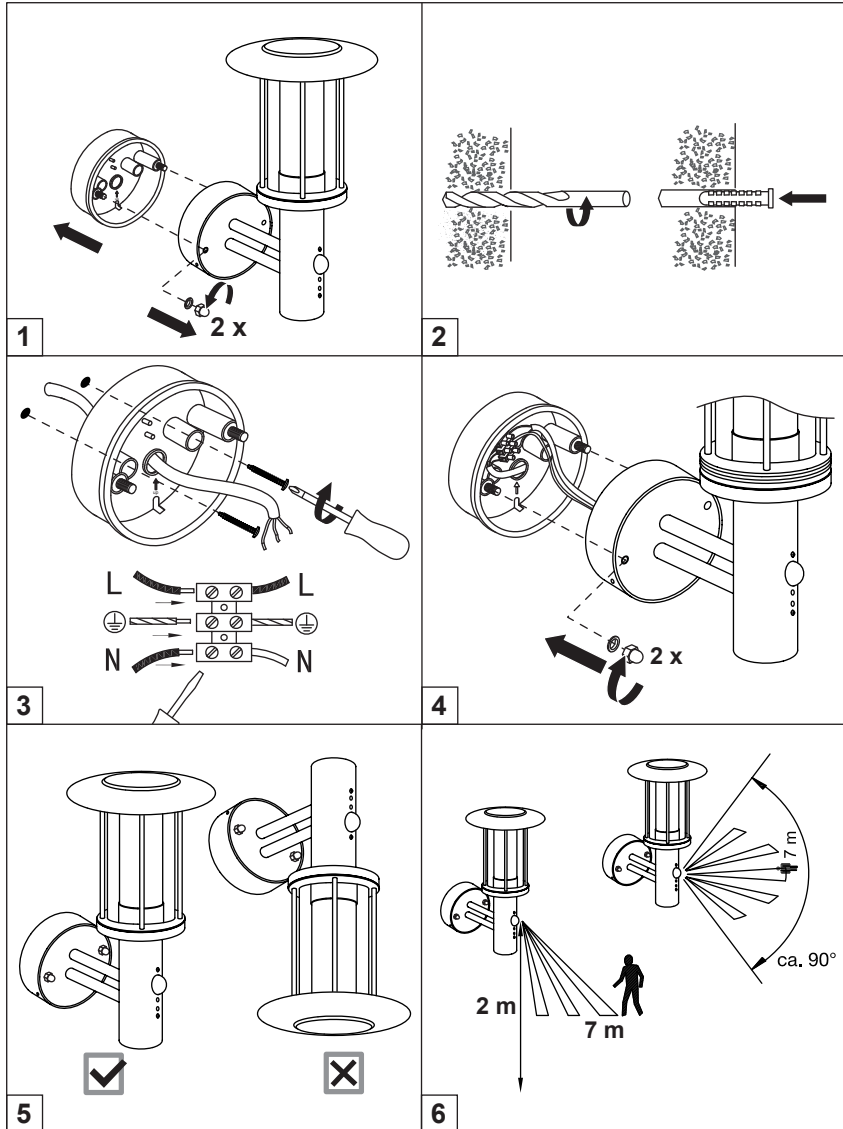
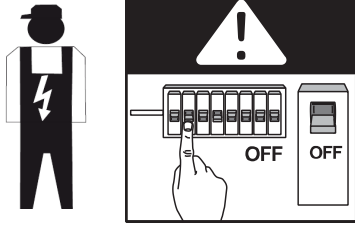

	(DE)	(GB)	(FR)	(NL)	(PL)	(NO)	(DK)
L	Stromführender Leiter	Live conductor	Conducteur	Spanningvoerende draad	Przewód prądowy	Strømførende leder	Strømførende leder
	Schutzleiter	Earth conductor	Conducteur de protection (terre)	Aardkabel	Przewód uziemiający	Jordledningen	Jordledningen
N	Neutralleiter	Neutral conductor	Conducteur neutre	Nulleider	Przewód zerowy	Nøytralleder	Neutralleder
	(SE)	(FI)	(IT)	(ES)	(CZ)	(PT)	(GR)
L	Strömförande ledare	Virtajohdin	Conduttore sotto tensione	Líneas conductoras de corriente	Vodič pod napětím	Condutor vivo	Ρευματοφόρος αγωγός
	Skyddsledare	Suojajohdin	Conduttore di terra	Conductor de protección	Ochranný vodič	Condutor de terra	Αγωγός γείωσης
N	Neutralledare	Nollajohdin	Conduttore neutro	Conductor neutro	Neutrální vodič	Condutor neutro	Ουδέτερος αγωγός

Funktionen / Fonctions / Functions

Taste	Funktionen	Fonctions	Functions
- Zeit +	<p>Festlegung der Leuchtdauer nach Ansprechen des Sensors. Wenn Sie den Regler im Uhrzeigersinn drehen, wird die Zeit erhöht, bei einer Drehung gegen den Uhrzeigersinn verringert. Die Leuchtdauer läßt sich von 10 (± 5) Sekunden bis zu 4 (±1) Minuten einstellen.</p> <p>Hinweis: Wurde die Leuchte einmal durch den Bewegungssensor ausgelöst, so wird die Leuchtdauer durch eine erneute Aktivierung entsprechend verlängert.</p>	<p>Tournez le bouton de commande TIME dans le sens "-" ou "+" pour contrôler la durée pendant laquelle la lumière reste allumée ((10 ± 5) secondes à (4 ± 1) minutes).</p> <p>Remarque: Lorsque la lampe est allumée, si un nouveau mouvement est détecté, le temps d'éclairage est prolongée en conséquence.</p>	<p>Turn the TIME control knob to "-" or "+" direction to control how long the light stay on (from about (10 ± 5) seconds to (4 ± 1) minutes).</p> <p>Remark: When the lamp is on, if a new movement is detected, the illumination time is recalculated from the last detected movement.</p>
- Sens +	<p>Sensibilität (SENS) steht hier für die maximale Distanz, bei der der Bewegungssensor noch durch sich bewegende Objekte ausgelöst wird. Durch Drehen des SENS-Knopfes von (+) nach (-) verringern Sie die Sensibilität.</p>	<p>La sensibilité signifie la distance maximale à laquelle le capteur PIR peut être déclenché par le mouvement. Tourner le bouton SENS de (+) à (-) diminuera la sensibilité.</p>	<p>The sensitivity means the Maximum distance which PIR Sensor can be triggered by movement body. Turning the SENS knob from (+) to (-) will decrease the sensitivity.</p>

	QR	EAN
<p>(DE) Dieses Produkt enthält eine Lichtquelle der Energieeffizienzklasse E (EN) This product contains a light source of energy efficiency class E (FR) Ce produit comprend une source de lumière de classe d'efficacité énergétique E (NL) Dit product bevat een lichtbron van energie-efficiëntieklasse E (PL) Produkt ten zawiera źródło światła o klasie efektywności energetycznej E (NO) Dette produktet inneholder en lyskilde i energieeffektivitetsklasse E (DK) Dette produkt indeholder en lyskilde af energieeffektklasse E (SE) Denna produkt innehåller en ljuskälla i energieeffektivitetsklass E (FI) Tämä tuote sisältää energiatehokkuusluokan E valonlähteen (IT) Questo prodotto contiene una sorgente luminosa della classe di efficienza energetica E (ES) Este producto contiene una fuente de luz de la clase de eficiencia energética E (CZ) Tento výrobek obsahuje světelný zdroj třídy energetické účinnosti E (PT) Este produto contém uma fonte de luz da classe de eficiência energética E (GR) Αυτό το προϊόν περιέχει μια φωτεινή πηγή ενεργειακής απόδοσης κλάσης E (SK) Tento výrobok obsahuje zdroj svetla triedy energetickej efektivity E</p>		<p>4251911714142</p>

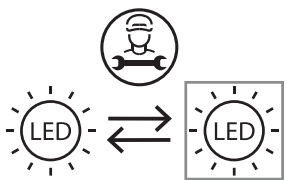
	<p>(DE) Durch einen Fachmann austauschbare Lichtquelle (nur LED) (EN) Replaceable (LED only) light source by a professional. (FR) Source de lumière remplaçable (LED uniquement) par un professionnel. (NL) Lichtbron (alleen led) te vervangen door een professional. (PL) Wymienne (tylko LED) źródło światła wykonane przez profesjonalistę. (NO) Utskiftbar (kun LED) lyskilde av en profesjonell. (DK) Udskiftelig lyskilde (kun LED), udskiftes af en elektriker. (SE) Ljuskälla (endast LED) utbytbar genom fackman. (FI) Ammattilainen voi vaihtaa vaihdettavan (vain LED) valonlähteen. (IT) Sorgente luminosa (solo LED) sostituibile da un professionista. (ES) Fuente de luz (solo LED) sustituible por un profesional. (CZ) Vyměnitelný (pouze LED) světelný zdroj odborníkem. (PT) Luz LED (apenas LED) substituível por um profissional. (GR) Η πηγή φωτός (μόνο LED) να αντικαθίσταται από επαγγελματία. (SK) Zdroj svetla (iba LED) vymeniteľný prostredníctvom odborníka.</p>
---	---

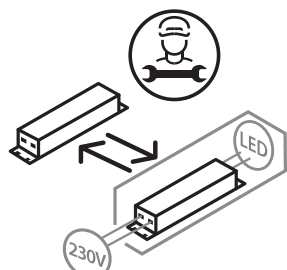
	<p>(DE) Durch einen Fachmann austauschbares Betriebsgerät. (EN) Replaceable control gear by a professional. (FR) Contrôleur remplaçable par un professionnel. (NL) Voorschakelapparatuur te vervangen door een professional. (PL) Wymienny układ sterujący przez profesjonalistę. (NO) Utskiftbar kontrollutstyr av en profesjonell. (DK) Udskiftelig igangsætter, udskiftes af en elektriker. (SE) Styrdon utbytbar genom fackman. (FI) Ammattilainen voi vaihtaa vaihdettavat ohjauslaitteet. (IT) Dispositivo di controllo sostituibile da un professionista. (ES) Dispositivo de control sustituible por un profesional. (CZ) Vyměnitelný předřadník odborníkem. (PT) Dispositivo de controlo substituível por um profissional. (GR) Ο εξοπλισμός ελέγχου να αντικαθίσταται από επαγγελματία. (SK) Predradník vymeniteľný prostredníctvom odborníka.</p>
---	--