

**9616263**

14W LED / 14,6W Total  
incl. LED Board: L9001703  
230V ~ 50Hz



### (DE) Bestimmungsgemäße Verwendung

(GB) Intended use / (FR) Utilisation conforme / (NL) Beoogd gebruik / (PL) Stosowanie zgodnie z przeznaczeniem / (NO) Riktig bruk / (DK) Korrekt brug / (SE) Avsedd användning / (FI) Määräystenmukainen käyttö

(IT) Impiego appropriato / (ES) Uso prescrito / (CZ) Použití v souladu s určením / (PT) Utilização correta / (GR) Ενδεδειγμένη χρήση

(DE)	Ortsfeste Verwendung als Wandleuchte im Außenbereich	(GB)	Provided for stationary use on walls, outdoors
(FR)	Installation fixe en tant qu'applique extérieure	(NL)	Vast gebruik als wandlamp buitenshuis
(PL)	Do montażu stacjonarnego jako lampa ścienna na zewnątrz	(NO)	Til stasjonært bruk som vegglyppe utendørs
(DK)	Til stationær brug som væglampe udendørs	(SE)	Används som fast vägglyppa utomhus
(FI)	Kiinteä käyttö ulkotilojen seinävalaisimena	(IT)	Impiego fisso come applique in ambienti esterni
(ES)	Empleo fijo en tanto lámpara de pared en el exterior	(CZ)	Stacionární použití jako nástěnné svítidlo v exteriéru
(PT)	Aplicação fixa como luminária de parede em exteriores	(GR)	Σταθερή χρήση ως φωτιστικό τοίχου σε εξωτερικό χώρο

### (DE) Verwendete Symbole

(GB) Safety Precautions / (FR) Symboles utilisés / (NL) Gebruikte symbolen / (PL) Stosowane symbole / (NO) Brukte symboler / (DK) Brugte symboler / (SE) Använda symboler / (FI) Käytetyt symbolit / (IT) Simboli usati / (ES) Símbolos empleados / (CZ) Použité symboly / (PT) Símbolos utilizados / (GR) Χρησιμοποιούμενα σύμβολα

IP 65

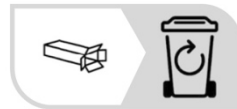

### (DE) Lieferumfang

(GB) Package contents / (FR) Contenu de la livraison / (NL) Bij de levering inbegrepen / (PL) Zakres dostawy / (NO) Levering / (DK) Leveringsomfang / (SE) Leveransomfattning / (FI) Toimitussisältö / (IT) Fornitura / (ES) Volumen de suministro / (CZ) Rozsah dodávky / (PT) Material fornecido / (GR) Παραδοτέος εξοπλισμός

(DE)	1 Wandleuchte Montagematerial Montageanleitung	(GB)	1 Wall light Installation hardware Mounting instructions	(FR)	1 Applique Matériel de montage Instructions de montage
(NL)	1 Wandlamp Monteringsmateriale Montagehandleiding	(PL)	1 Lampa ścienna Elementy montażowe Instrukcja montażu	(NO)	1 Vegglyppe Monteringsmateriale Brukerveiledning
(DK)	1 Væglampe Monteringsmateriale Brugervejledning	(SE)	1 Vægglyppa Monteringsmaterial Monteringsanvisning	(FI)	1 Seinävalaisin Asennusmateriaali Asennusohjeet
(IT)	1 Applique Materiale di montaggio Istruzioni di montaggio	(ES)	1 Lámpara de pared Material de montaje Instrucciones de montaje	(CZ)	1 Nástěnné svítidlo Materiál pro montáž Návod k montáži
(PT)	1 Luminária de parede Material de montagem Instruções de montagem	(GR)	1 Φωτιστικό τοίχου Υλικό συναρμολόγησης Οδηγίες συναρμολόγησης		

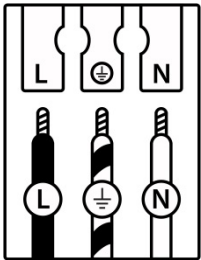
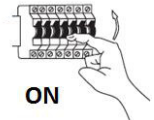
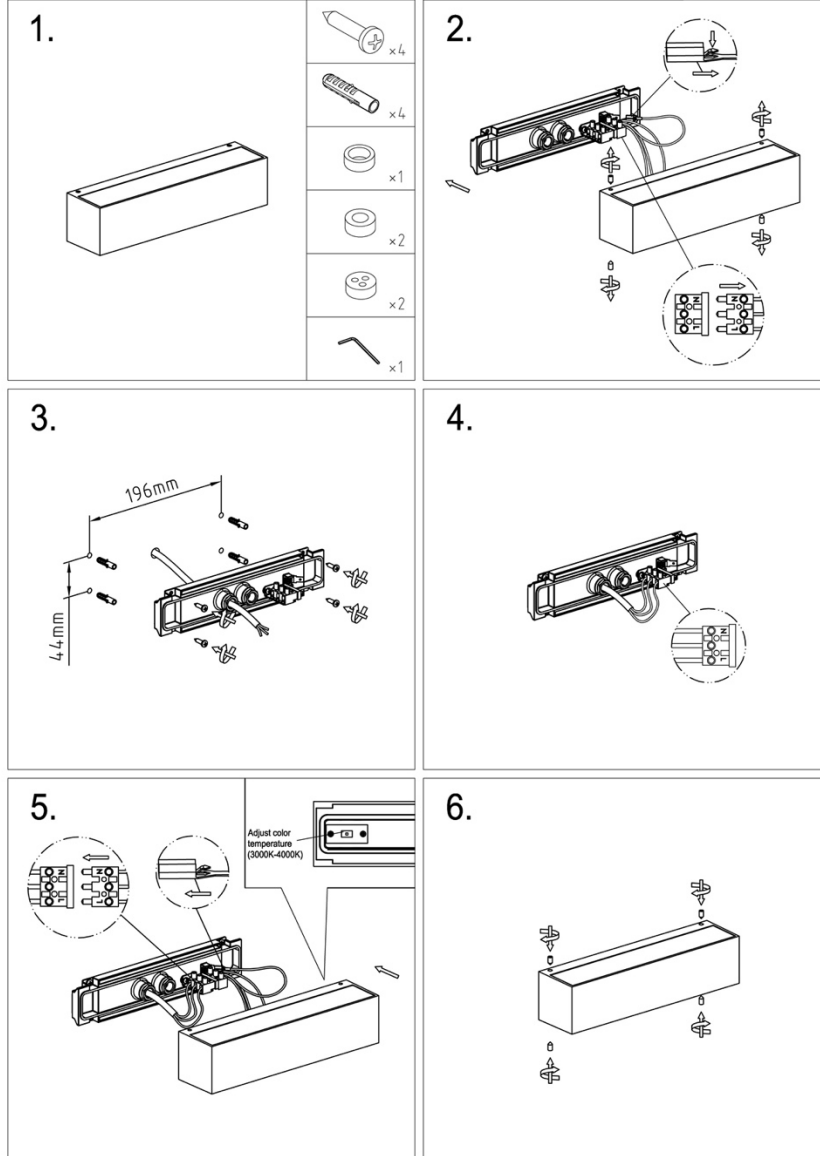
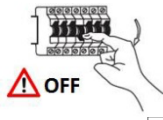

	(DE)	(GB)	(FR)	(NL)	(PL)	(NO)	(DK)
<b>L</b>	Stromführender Leiter	Live conductor	Conducteur	Spanningvoerende draad	Przewód prądowy	Strømførende leder	Strømførende leder
	Schutzleiter	Earth conductor	Conducteur de protection (terre)	Aardkabel	Przewód uziemiający	Jordledningen	Jordledningen
<b>N</b>	Neutralleiter	Neutral conductor	Conducteur neutre	Nulleider	Przewód zerowy	Nøytralleder	Neutralleider
	(SE)	(FI)	(IT)	(ES)	(CZ)	(PT)	(GR)
<b>L</b>	Strömförande ledare	Virtajohdin	Conduttore sotto tensione	Conductor de corriente	Vodič pod napětím	Condutor vivo	Ρευματοφόρος αγωγός
	Skyddsledare	Suojajohdin	Conduttore di terra	Conductor de protección	Ochranný vodič	Condutor de terra	Αγωγός γείωσης
<b>N</b>	Neutralledare	Nollajohdin	Conduttore neutro	Conductor neutro	Neutrální vodič	Condutor neutro	Ουδέτερος αγωγός

<p><b>(DE)</b> Dieses Produkt enthält eine Lichtquelle der Energieeffizienzklasse E  <b>(EN)</b> This product contains a light source of energy efficiency class E  <b>(FR)</b> Ce produit comprend une source de lumière de classe d'efficacité énergétique E  <b>(NL)</b> Dit product bevat een lichtbron van energie-efficiëntieklasse E  <b>(PL)</b> Produkt ten zawiera źródło światła o klasie efektywności energetycznej E  <b>(NO)</b> Dette produktet inneholder en lyskilde i energieeffektivitetsklasse E  <b>(DK)</b> Dette produkt indeholder en lyskilde af energieeffektklasse E  <b>(SE)</b> Denna produkt innehåller en ljuskälla i energieffektivitetsklass E  <b>(FI)</b> Tämä tuote sisältää energiatehokkuusluokan E valonlähteen  <b>(IT)</b> Questo prodotto contiene una sorgente luminosa della classe di efficienza energetica E  <b>(ES)</b> Este producto contiene una fuente de luz de la clase de eficiencia energética E  <b>(CZ)</b> Tento výrobek obsahuje světelný zdroj třídy energetické účinnosti E  <b>(PT)</b> Este produto contém uma fonte de luz da classe de eficiência energética E  <b>(GR)</b> Αυτό το προϊόν περιέχει μια φωτεινή πηγή ενεργειακής απόδοσης κλάσης E  <b>(SK)</b> Tento výrobok obsahuje zdroj svetla triedy energetickej efektivity E</p>	<p style="text-align: center;"><b>QR</b></p> 	<p style="text-align: center;"><b>EAN</b></p> <p style="text-align: center;">4251911724387</p>
---	--	--

	<p><b>(DE)</b> Die Lichtquelle dieser Leuchte ist nicht ersetzbar.  <b>(EN)</b> The light source is not replaceable.  <b>(FR)</b> La source lumineuse de cette lampe n'est pas remplaçable.  <b>(NL)</b> De lichtbron van deze lamp is niet vervangbaar.  <b>(PL)</b> Źródło światła w tej lampie jest niewymienne.  <b>(NO)</b> Lyskilden i denne lampen er ikke mulig å bytte ut.  <b>(DK)</b> Lyskilden til denne lampe kan ikke udskiftes.  <b>(SE)</b> Ljuskällan i denna lampa är inbyggd och är inte utbytbar.  <b>(FI)</b> Tämän valaisimen valonlähde ei voi vaihtaa.  <b>(IT)</b> La sorgente luminosa di questa lampada non è sostituibile.  <b>(ES)</b> La fuente de luz de esta lámpara no es reemplazable.  <b>(CZ)</b> Světelný zdroj nelze vyměnit.  <b>(PT)</b> A fonte de luz deste candeeiro não permite a substituição.  <b>(GR)</b> Η πηγή φωτισμού αυτού του φωτιστικού δεν μπορεί να αντικατασταθεί.  <b>(SK)</b> Svetelný zdroj tohto svietidla nie je vymeniteľný.</p>
--	---

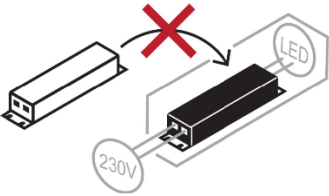
	<p><b>(DE)</b> Das Betriebsgerät dieser Leuchte ist nicht ersetzbar.  <b>(EN)</b> The control gear is not replaceable.  <b>(FR)</b> Le ballast de ce luminaire n'est pas remplaçable.  <b>(NL)</b> Het voorschakelapparaat is bij dit artikel niet vervangbaar.  <b>(PL)</b> Statecznik w lampie jest niewymienny  <b>(NO)</b> Kontrollutstyret til denne armaturen kan ikke skiftes ut.  <b>(DK)</b> Denne lampes ballast kan ikke udskiftes.  <b>(SE)</b> Armaturens styranordning är inte utbytbar.  <b>(FI)</b> Tämän valaisimen ohjauslaitetta ei voi vaihtaa.  <b>(IT)</b> Il dispositivo di alimentazione di questa lampada non è sostituibile.  <b>(ES)</b> El balastro de esta lámpara no es reemplazable.  <b>(CZ)</b> Ovládací zařízení tohoto svítidla není vyměnitelné.  <b>(PT)</b> O equipamento de controlo desta luminária não é substituível.  <b>(GR)</b> Ο μηχανισμός ελέγχου αυτού του φωτιστικού δεν μπορεί να αντικατασταθεί.  <b>(SK)</b> Ovládacie zariadenie tohto svietidla nie je vymeniteľné.</p>
---	--