

9621333

1xG9max.5W LED  
230V~50Hz**(DE)BestimmungsgemäßeVerwendung**

(GB)Intendeduse/(FR)Utilisationconforme/(NL)Beoogdegebruik/(PL)Stosowaniezgodniezprzeznaczeniem/  
(NO)Riktigbruk/(DK)Korrektbrug/(SE)Avseddanvändning/(FI)Määräystenmukainenkäyttö  
(IT)Impiegoappropriato/(ES)Usoprescrito/(CZ)Použitívouladusurčeniím/(PT)Utilizaçãocorreta/(GR)Ενδεδειγμένηχρήση

(DE)	OrtsfesteVerwendungalsWandleuchteimInnenbereich	(GB)	Providedforstationaryuseonwalls,indoors
(FR)	Installationfixeentantqu'applique,àl'intérieur	(NL)	Vastgebruikalswandlampbinnenshuis
(PL)	Domontażustacjonarnegojakolampaściennadownętrz	(NO)	Tilstasjonærtbruksomvegglampeinnendørs
(DK)	Tilstationærbrugsomvægglampeindendørs	(SE)	Användssomfastvägglampainomhus
(FI)	Kiinteäkäyttöösisätilojenseinävalaisimena	(IT)	Impiegofissocomeappliqueinambientiinterni
(ES)	Empleofijoentantolámparadeparedeninteriores	(CZ)	Stacionárnířoužitíjakonástěnnésvítidlovinteriéru
(PT)	Aplicaçãofixacomolumináriadeparedeminteriores	(GR)	Σταθερήχρήσηωςφωτιστικότοίχουσεεσωτερικόχώρο

**(DE)VerwendeteSymbole**

(GB)SafetyPrecautions/(FR)Symbolesutilizes/(NL)Gebruiktesymbolen/(PL)Stosowanesympbole/(NO)Bruktesymboler/  
(DK)Brugtesymboler/(SE)Användasymboler/(FI)Käytetytsymbolit/(IT)Simboliusati/(ES)Símbolosempleados/  
(CZ)Použitésymboly/(PT)Símbolosutilizados/(GR)Χρησιμοποιούμενασύμβολα

IP20

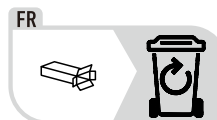
**(DE)Lieferumfang**

(GB)Packagecontents/(FR)Contenudelalivraison/(NL)Bijdeleveringinbegrepen/(PL)Zakresdostawy/(NO)Levering/  
(DK)Leveringsomfang/(SE)Leveransomfattning/(FI)Toimitussisältö/(IT)Fornitura/(ES)Volumendesuministro/  
(CZ)Rozsahdodávky/(PT)Materialfornecido/(GR)Παραδοτέοςεξοπλισμός

(DE)	1Wandleuchte Montagematerial Montageanleitung	(GB)	1Walllight Installationhardware Mountinginstructions	(FR)	1Applique Matérialdemontage Instructionsdemontage
(NL)	1Wandlamp Monteringsmateriale Montagehandleiding	(PL)	1Lampaścienna Elementymontażowe Instrukcjamontażu	(NO)	1Veggglampe Monteringsmateriale Brukerveiledning
(DK)	1Vægglampe Monteringsmateriale Brugervejledning	(SE)	1Väggglampa Monteringsmaterial Monteringsanvisning	(FI)	1Seinävalaisin Asennusmateriaali Asennusohjeet
(IT)	1Applique Materiale dimontaggio Istruzioni dimontaggio	(ES)	1Lámparadepared Materialdemontaje Instruccionesdemontaje	(CZ)	1Nástěnnésvítidlo Materiálpromontáž Návodkmontáži
(PT)	1Lumináriadeparede Materialdemontagem Instruçõesdemontagem	(GR)	1Φωτιστικότοίχου Υλικόσυναρμολόγησης Οδηγίεςσυναρμολόγησης		

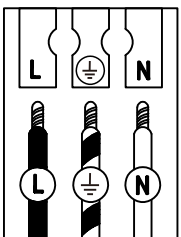
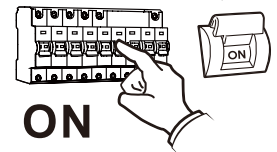
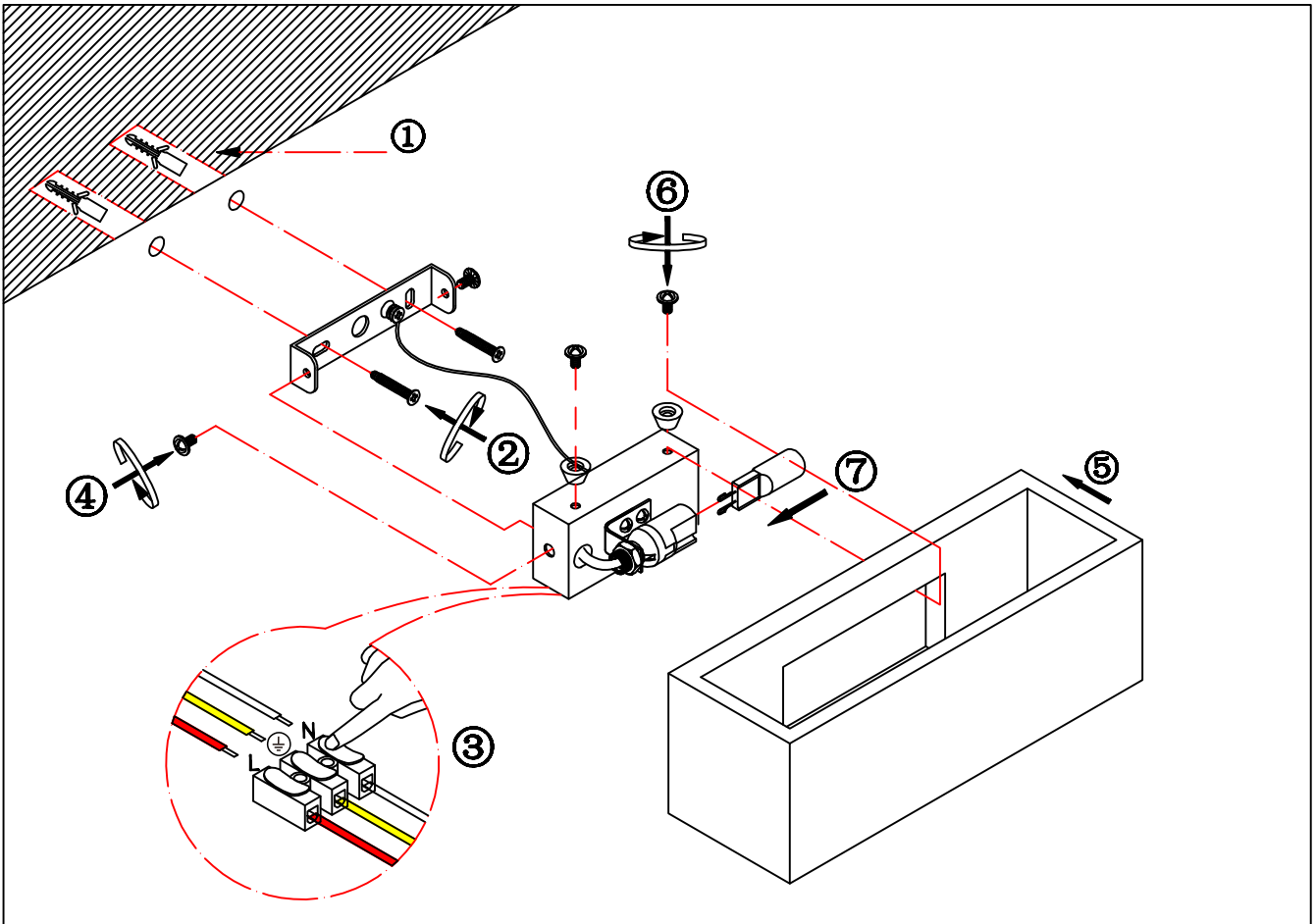
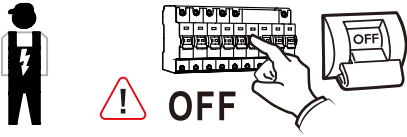

	(DE)	(GB)	(FR)	(NL)	(PL)	(NO)	(DK)
<b>L</b>	Stromführender Leiter	Liveconductor	Conducteur	Spanningvoerendraad	Przewód prądowy	Strømførende leder	Strømførende leder
	Schutzleiter	Earth conductor	Conducteurde protection (terre)	Aardkabel	Przewód uziemiający	Jordledningen	Jordledningen
<b>N</b>	Neutralleiter	Neutral conductor	Conducteur neutre	Nulleider	Przewód zerowy	Nøytralleider	Neutralleider

	(SE)	(FI)	(IT)	(ES)	(CZ)	(PT)	(GR)
<b>L</b>	Strömförande ledare	Virtajohdin	Conduttore sotto tensione	Líneas conductoras de corriente	Vodič pod napětím	Condutor vivo	Ρευματοφόρος αγωγός
	Skyddsledare	Suojajohdin	Conduttore di terra	Conductor de protección	Ochranný vodič	Condutor de terra	Αγωγός γείωσης
<b>N</b>	Neutralledare	Nollajohdin	Conduttore neutro	Conductor neutro	Neutrální vodič	Condutor neutro	Ουδέτερος αγωγός