

9616206

18W LED / 18W Total
incl. LED Board: L9001385
230V ~ 50Hz

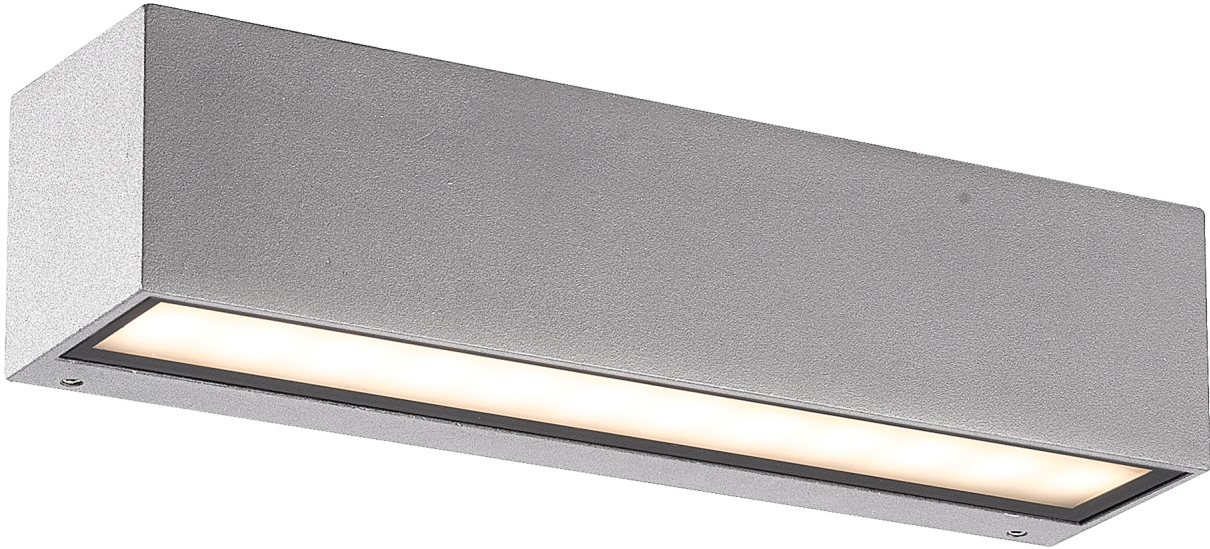

(DE) Bestimmungsgemäße Verwendung

(EN) Intended use | (FR) Utilisation conforme | (NL) Beoogd gebruik | (PL) Stosowanie zgodnie z przeznaczeniem | (NO) Riktig bruk | (DK) Korrekt brug
(SE) Avsedd användning | (FI) Määräystenmukainen käyttö | (IT) Impiego appropriato | (ES) Uso prescrito | (CZ) Použití v souladu s určením
(PT) Utilização correta | (GR) Ενδεδειγμένη χρήση | (SK) Predpokladané použitie | (EE) Eeldatav kasutus | (LV) Paredzamais lietojums
(LT) Numatomas naudojimas | (RO) Utilizare intenționată | (SI) Predvidena uporaba | (HR) Namjenska upotreba | (HU) Tervezett felhasználás
(BG) предназначена употреба | (AL) Përdorimi i parashikuar | (MK) Предвидена употреба | (TR) Amaçlı kullanım | (UK) Призначене використання
(BA,ME,RS) Namjenska upotreba

(DE)	Ortsfeste Verwendung als Wandleuchte im Außenbereich	(GB)	For stationary use outdoors as a wall light
(FR)	Installation fixe en tant qu'applique extérieure	(NL)	Vast gebruik als wandlamp buitenshuis
(PL)	Do montażu stacjonarnego jako lampa ścienna na zewnątrz	(NO)	Til stasjonært bruk som vegglampe utendørs
(DK)	Til stationær brug som væglampe udendørs	(SE)	Används som fast väglampa utomhus
(FI)	Kiinteä käyttö ulkotilojen seinävalaisimena	(IT)	Impiego fisso come applique in ambienti esterni
(ES)	Empleo fijo en tanto lámpara de pared en el exterior	(CZ)	Stacionární použití jako nástěnné svítidlo v exteriéru
(PT)	Aplicação fixa como luminária de parede em exteriores	(GR)	Σταθερή χρήση ως φωτιστικό τοίχου σε εξωτερικό χώρο
(SK)	Na stacionárne použitie vo vonkajšom prostredí ako nástenné svetlo	(BG)	За стационарна употреба на открито като стенна лампа
(EE)	Statsionaarseks kasutamiseks õues seinavalgustina	(LV)	Stacionāram lietojumam ārpus telpām kā sienas gaismeklis
(LT)	Stacionariam naudojimui lauke kaip sieninis šviestuvus	(RO)	Pentru utilizare staționară în exterior ca lampă de perete
(SI)	Za stacionarno uporabo na prostem kot stenska svetilka	(HR)	Za stacionarnu upotrebu na otvorenom kao zidna svjetiljka
(HU)	Helyhez kötött használatra kültéren falilámpaként	(AL)	Për përdorim të palëvizshëm jashtë si dritë murale
(MK)	За стационарна употреба надвор како светилка на ѕид	(TR)	Durağan kullanım için dış mekanda duvar lambası olarak
(UK)	Для стаціонарного використання на вулиці як світильник на стіну	(BA)	Za stacionarnu upotrebu na otvorenom kao zidna svjetiljka
		(ME)	
		(RS)	

(DE) Lieferumfang		
(EN) Package contents (FR) Contenu de la livraison (NL) Bij de levering inbegrepen (PL) Zakres dostawy (NO) Levering (DK) Leveringsomfang (SE) Leveransomfattning (FI) Toimitussisältö (IT) Fornitura (ES) Volumen de suministro (CZ) Rozsah dodávky (PT) Material fornecido (GR) Παραδοτέος εξοπλισμός (SK) Obsah balenia (EE) Pakendi sisu (LV) Pakas saturs (LT) Pakuotės turinys (RO) Conținutul pachetului (SI) Vsebina paketa (HR) Sadržaj paketa (HU) A csomag tartalma (BG) обхват на доставката (AL) Përmbajtja e dorëzimit (MK) Содржина на испорака (TR) Teslimat içeriği (UK) Зміст доставки (BA,ME,RS) Sadržaj isporuke		
(DE) 1 Wandleuchte Montagematerial Montageanleitung	(GB) 1 Wall light Installation hardware Mounting instructions	(FR) 1 Applique Matériel de montage Instructions de montage
(NL) 1 Wandlamp Monteringsmateriale Montagehandleiding	(PL) 1 Lampa ścienna Elementy montażowe Instrukcja montażu	(NO) 1 Vegglampe Monteringsmateriale Brukerveiledning
(DK) 1 Væglampe Monteringsmateriale Brugervejledning	(SE) 1 Vägglampa Monteringsmaterial Monteringsanvisning	(FI) 1 Seinävalaisin Asennus materiaali Asennusohjeet
(IT) 1 Applique Materiale di montaggio Istruzioni di montaggio	(ES) 1 Lámpara de pared Material de montaje Instrucciones de montaje	(CZ) 1 Nástěnné svítidlo Materiál pro montáž Návod k montáži
(PT) 1 Luminária de parede Material de montagem Instruções de montagem	(GR) 1 Φωτιστικό τοίχου Υλικό συναρμολόγησης Οδηγίες συναρμολόγησης	(SK) 1 nástenné svetidlo Inštalačný hardvér Inštalačná príručka
(BG) 1 стенна лампа материали за монтаж инструкции за монтаж	(EE) 1 seinavalgusti Paigaldustarvikud Paigaldusjuhend	(LV) 1 sienas lampa Instalācijas aparatūra Uzstādīšanas instrukcija
(LT) 1 sieninis šviestuvas Montavimo aparatinė įranga Montavimo instrukcija	(RO) 1 lampă de perete Hardware de instalare Instrucțiuni de montare	(SI) 1 stenska svetilka Namestitvena strojna oprema Navodila za montažo
(HR) 1 Zidno svjetlo Instalacijski hardver Upute za montažu	(HU) 1 fali lámpa Telepítési hardver Szerelési útmutató	(AL) 1 dritë murale Materiali i montimit Udhëzuesi i montimit
(MK) 1 светилка на ѕид Монтажен материјал Упатство за монтажа	(TR) 1 duvar lambası Montaj malzemesi Montaj kılavuzu	(UK) 1 duvar lambasi Монтажний матеріал Інструкція з монтажу
(BA) 1 zidna svjetiljka (ME) Montažni materijal (RS) Uputstvo za montažu		

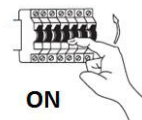
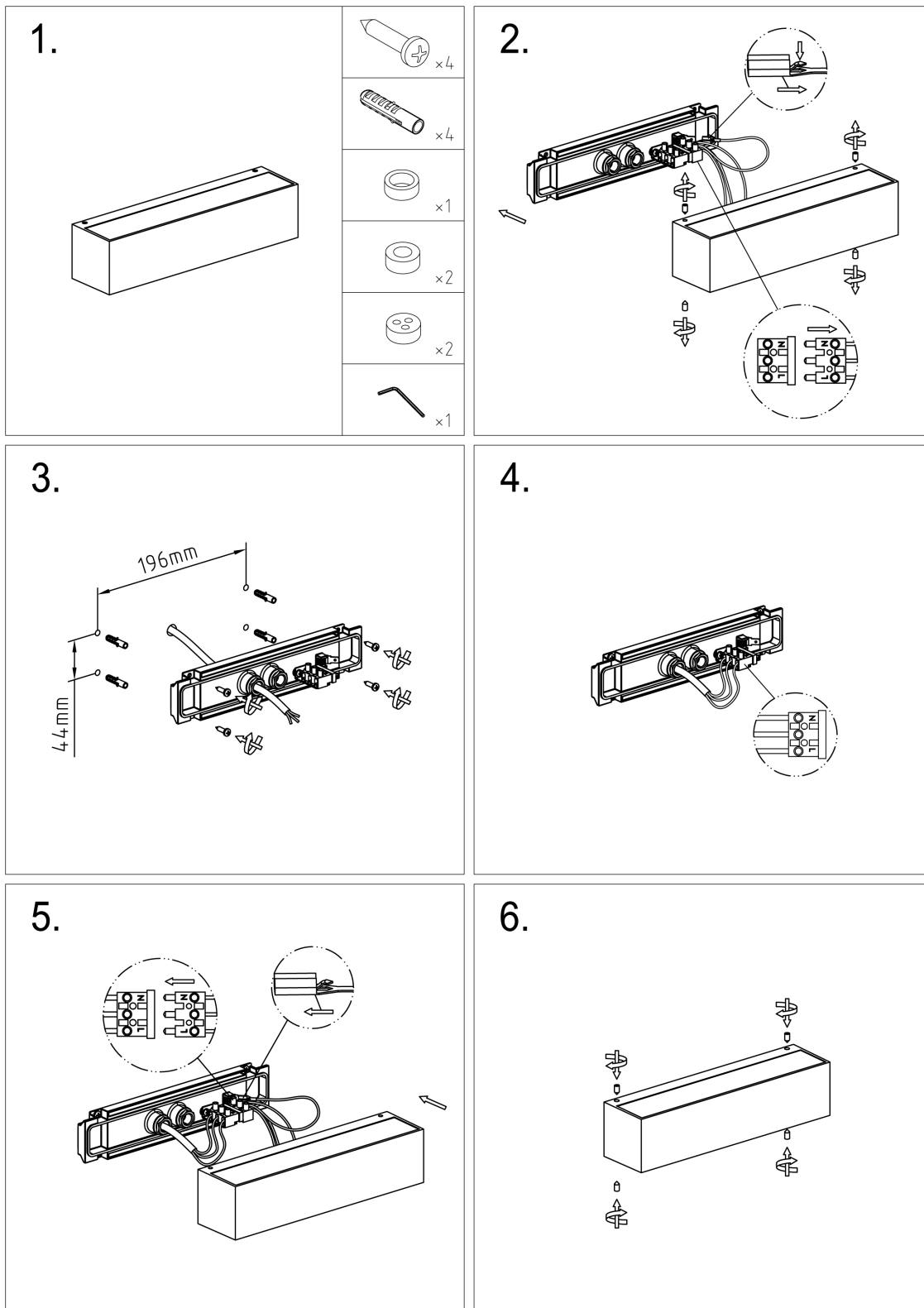
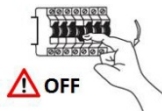



ON

	(DE)	(EN)	(FR)	(NL)	(PL)	(NO)
L	Stromführender Leiter	Live conductor	Conducteur	Spanningvoerende draad	Przewód prądowy	Strømførende leder
	Schutzleiter	Earth conductor	Conducteur de protection (terre)	Aardkabel	Przewód uziemiający	Jordledningen
N	Neutralleiter	Neutral conductor	Conducteur neutre	Nulleider	Przewód zerowy	Nøytralleder

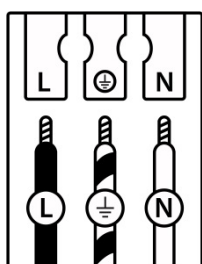
	(DK)	(SE)	(FI)	(IT)	(ES)	(CZ)
L	Strømførende leder	Strömförande ledare	Virtajohdin	Conduttore sotto tensione	Conductor de corriente	Vodič pod napětím
	Jordledningen	Skyddsledare	Suojajohdin	Conduttore di terra	Conductor de protección	Ochranný vodič
N	Neutralleder	Neutralledare	Nollajohdin	Conduttore neutro	Conductor neutro	Neutrální vodič



	(PT)	(GR)	(SK)	(EE)	(LV)	(LT)
L	Condutor vivo	Ρευματοφόρος αγωγός	Živý vodič	Faasisjuht	Dzīvais vadītājs	Gyvas dirigentas
	Condutor de terra	Αγωγός γείωσης	Zemný vodič	Maandusjuht	Zemes vadītājs	Žemės dirigentas
N	Condutor neutro	Ουδέτερος αγωγός	Neutrálny vodič	Neutraaljuht	Neitrālais vadītājs	Neutrinis dirigentas

	(RO)	(SI)	(HR)	(HU)	(BG)	(AL)
L	Conductor viu	Živi dirigent	Živi dirigent	Élő vezető	проводник под напряжение	Konduktor i gjallë
	Conductor de împământare	Zemeljski dirigent	Uzemljeni dirigent	Földvezető	защитен проводник	Dirigjent i tokës
N	Conductor neutru	Nevtralni dirigent	Neutralni dirigent	Semleges vezető	нулев проводник	Kondaktor neutral

	(MK)	(TR)	(UK)	(BA)(ME)(RS)
L	Жив кондуктор	Canlı yönetici	Живий диригент	Živi dirigent
	Земјен проводник	Toprak iletkeni	Земельний провідник	Zemaljski provodnik
N	Неутрален проводник	Nötr iletken	Нейтральний провідник	Neutralni provodnik

(DE) Verwendete Symbole

(EN) Safety Precautions | (FR) Symboles utilisés | (NL) Gebruikte symbolen | (PL) Stosowane symbole | (NO) Brukte symboler | (DK) Brugte symboler | (SE) Använda symboler | (FI) Käytetyt symbolit | (IT) Simboli usati | (ES) Símbolos empleados | (CZ) Použité symboly | (PT) Símbolos utilizados | (GR) Χρησιμοποιούμενα σύμβολα | (SK) Bezpečnostné opatrenia | (EE) Ohutusabinõud | (LV) Drošības pasākumi | (LT) Saugos priemonės | (RO) Măsuri de precauție | (SI) Varnostni ukrepi | (HR) Mjere opreza | (HU) Használt szimbólumok | (BG) Мерки за безопасност | (AL) Simbolet e përdorura | (MK) Користени симболи | (TR) Kullanılan semboller | (UK) Використовувані символи | (BA,ME,RS) Korišteni simboli

IP 65



<p>(DE) Dieses Produkt enthält eine Lichtquelle der Energieeffizienzklasse E (EN) This product contains a light source of energy efficiency class E (FR) Ce produit comprend une source de lumière de classe d'efficience énergétique E (NL) Dit product bevat een lichtbron van energie-efficiëntieklasse E (PL) Produkt ten zawiera źródło światła o klasie efektywności energetycznej E (NO) Dette produktet inneholder en lyskilde i energieeffektivitetsklasse E (DK) Dette produkt indeholder en lyskilde af energieeffektklasse E (SE) Denna produkt innehåller en ljuskälla i energieeffektivitetsklass E (FI) Tämä tuote sisältää energiatehokkuusluokan E valonlähteen (IT) Questo prodotto contiene una sorgente luminosa della classe di efficienza energetica E (ES) Este producto contiene una fuente de luz de la clase de eficiencia energética E (CZ) Tento výrobek obsahuje světelný zdroj třídy energetické účinnosti E (PT) Este produto contém uma fonte de luz da classe de eficiência energética E (GR) Αυτό το προϊόν περιέχει μια φωτεινή πηγή ενεργειακής απόδοσης κλάσης E (SK) Tento výrobok obsahuje zdroj svetla triedy energetickej efektivity E (EE) See toode sisaldab energiatõhususklassi E valgusallikat (LV) Šis produkts satur enerģijas efektivitātes klases E gaismas avotu (LT) Šis gaminys turi energijos efektyvumo klasės E šviesos šaltinį (RO) Acest produs conține o sursă de lumină de clasă de eficiență energetică E (SI) Ta izdelek vsebuje svetlobni vir energijskega razreda E (HR) Ovaj proizvod sadrži izvor svjetlosti energetske učinkovitosti klase E (HU) Ez a termék egy E energiahatékonysági osztályú fényforrást tartalmaz (BG) Този продукт съдържа източник на светлина с клас на енергийна ефективност: E (AL) Ky produkt përmban një burim drite të klasës së efikasitetit të energjisë E (MK) Овој производ содржи извор на светлина од класа на енергетска ефикасност E (TR) Bu ürün, enerji verimliliği sınıfı E olan bir ışık kaynağı içerir (UK) Цей продукт містить джерело світла класу енергоефективності E (BA)(ME)(RS) Ovaj proizvod sadrži izvor svjetlosti energetske klase E</p>	<p>QR</p> 	<p>EAN</p> <p>4251911717181</p>
---	---	---------------------------------

	<p>(DE) Die Lichtquelle dieser Leuchte ist nicht ersetzbar. (EN) The light source is not replaceable. (FR) La source lumineuse de cette lampe n'est pas remplaçable. (NL) De lichtbron van deze lamp is niet vervangbaar. (PL) Źródło światła w tej lampie jest niewymienne. (NO) Lyskilden i denne lampen er ikke mulig å bytte ut. (DK) Lyskilden til denne lampe kan ikke udskiftes. (SE) Ljuskällan i denna lampa är inbyggd och är inte utbytbar. (FI) Tämän valaisimen valonlähde ei voi vaihtaa. (IT) La sorgente luminosa di questa lampada non è sostituibile. (ES) La fuente de luz de esta lámpara no es reemplazable. (CZ) Světelný zdroj nelze vyměnit. (PT) A fonte de luz deste candeeiro não permite a substituição. (GR) Η πηγή φωτισμού αυτού του φωτιστικού δεν μπορεί να αντικατασταθεί. (SK) Svetelný zdroj tohto svietidla nie je vymeniteľný. (EE) Valgusallikat ei saa asendada. (LV) Gaismas avots nav aizstājams. (LT) Šviesos šaltinis nekeičiamas. (RO) Sursa de lumină nu poate fi înlocuită. (SI) Vir svetlobe ni zamenljiv. (HR) Izvor svjetla nije zamjenjiv. (HU) A fényforrás nem cserélhető ki. (BG) Източникът на светлина не може да се замени. (AL) Burimi i dritës nuk mund të zëvendësohet. (MK) Изворот на светлина не е заменлив. (TR) Işık kaynağı değiştirilemez. (UK) Джерело світла не можна замінити. (BA)(ME)(RS) Izvor svjetlosti nije zamjenjiv.</p>
---	---