

DOMENICA wall lamp

Dario De Meo and Luca De Bona design

year 2015

TECHNICAL SHEET - AP102 1B INT

STRUCTURE "A"

| | | |
|----------|------------|---|
| material | plaster |  |
| colour | matt white | |

STRUCTURE "B"

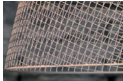
| | | |
|----------|--------------|---|
| material | wire netting |  |
| colour | white | |

ELECTRICAL CABLE

| | |
|--------------|---------------|
| socket | E27 |
| source | max 1x52w |
| energy class | from E to A++ |

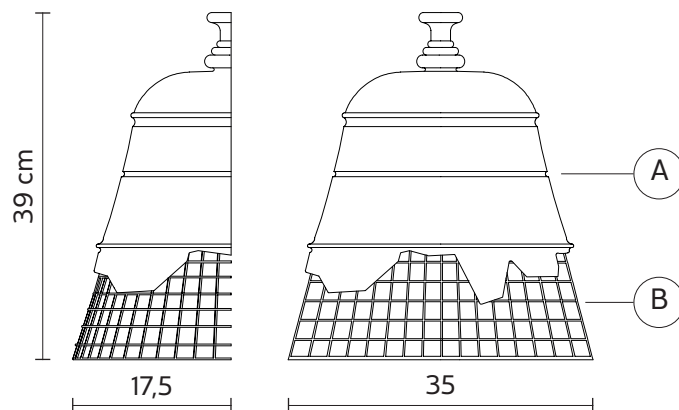





PACKAGING

| | |
|-----------------|----------|
| nr.of collis | 1 |
| net weight/kg | 3,2 |
| gross weight/kg | 4,1 |
| packaging/cm | 43x44x29 |

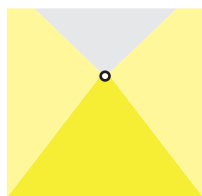
EMISSION OF LIGHT

one directional



| | |
|---|----------|
|  | direct |
|  | filtered |
|  | indirect |
|  | none |



CERTIFICATION

| | |
|-----|-------------------------|
| IEC | 60598-1:2008 |
| EN | 60598-1:2008 + A11:2009 |



| | |
|---------|--------------|
| IP rate | IP20 |
| bulb | not provided |

COLLECTION

available also as: suspension

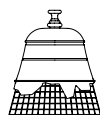

AP1021OINT