





EN Table lamp. Opal diffuser made of two layers of blown glass. Enamel ceramic body decorated with the "third firing" technique.

IT Lampada da tavolo. Diffusore in vetro opale incamiciato e soffiato. Corpo in ceramica smaltata e decorata con la tecnica del "terzo fuoco".



#### CERTIFICATIONS / CERTIFICAZIONI

-  Product in class II  
Apparecchio di classe II
- IP20 Product for indoor use  
Apparecchio per uso interno
-  Product in conformity with the European directive 2006/95/EC  
Apparecchio conforme alla direttiva europea 2006/95/EC
-  Product in conformity with the Eurasian Custom Unions technical regulations  
Apparecchio conforme ai regolamenti tecnici dell'Unione doganale Eurasiatica
-  USA and Canada conformity seal  
Marchio di conformità USA e Canada
-  This lamp must be disposed in conformity with the EU directive 2002/96/EC  
Apparecchio di illuminazione da smaltire secondo la direttiva EU 2002/96/EC

#### CODES AND DIMENSIONS / CODICI E DIMENSIONI

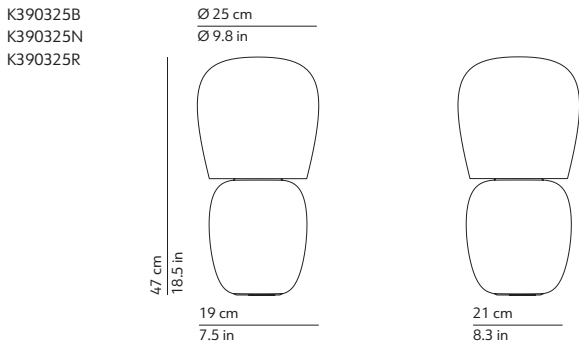

#### PACKAGING / IMBALLO

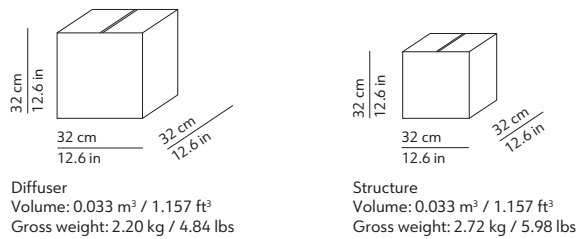

#### MATERIALS AND FINISHINGS / MATERIALI E FINITURE

##### DIFFUSER / DIFFUSORE

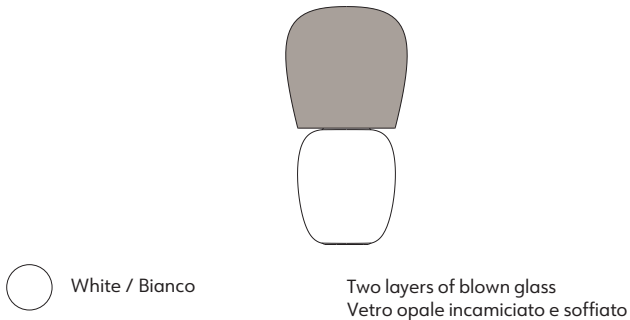

##### STRUCTURE / STRUTTURA

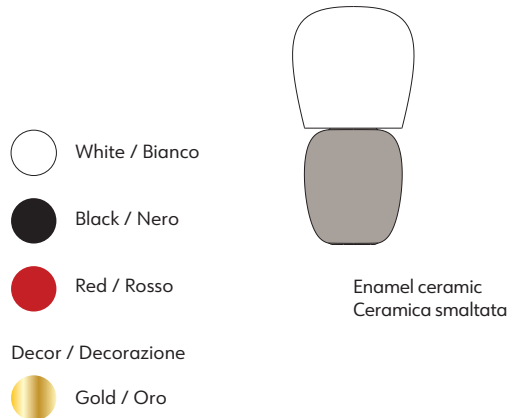

#### FURTHER INFORMATION / INFORMAZIONI AGGIUNTIVE

230V or 120V Feeding / Alimentazione

Bulbs / Lampadine  
1 x 30W - E27 (E26 US)

 Energy efficiency class from A++ to E

 Dimmer / Varialuce  
No

 Table lamp  
Lampada da tavolo

 Transparent cord set  
EU or UK plug  
Cavo di alimentazione trasparente  
Spina EU o UK

 Transparent loose switch  
Interruttore rompifilo trasparente