

Ø250

112

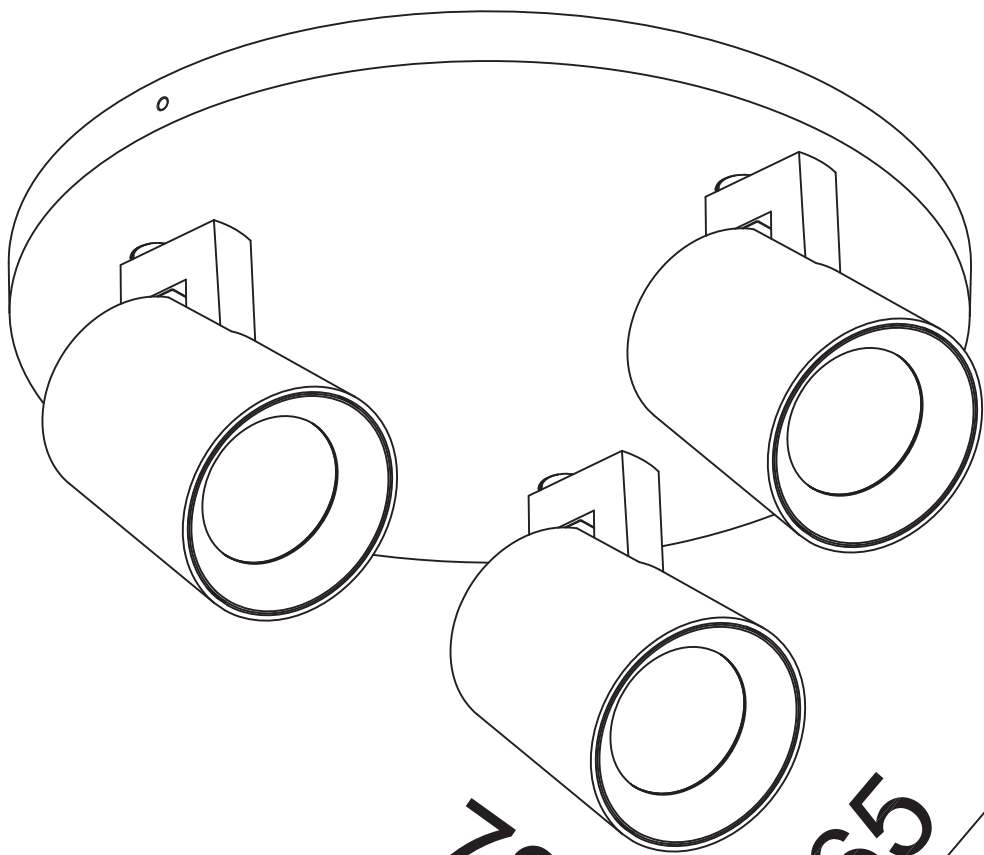

78

Ø65