

IT

- 1 - Seguire attentamente le istruzioni di montaggio e d'uso per garantirne un funzionamento corretto e sicuro dell'apparecchio.
- 2 - Conservare le Istruzioni per futura necessità. Per eventuali problemi contattare il rivenditore.
- 3 - Il prodotto non deve essere modificato. Qualsiasi modifica annulla le approvazioni di sicurezza e può rendere pericoloso l'apparecchio.
- 4 - Rotaliana declina ogni responsabilità per danni causati a cose o a persone da un non corretto uso dell'apparecchio.
- 5 - Fare riferimento al sito web www.rotaliana.it per le istruzioni di disassemblaggio a fine vita del prodotto.

EN

- 1 - Follow carefully the assembly and use instructions to guarantee a correct and safe function of the luminaire.
- 2 - Keep the instructions for future needs. For any problems, get in touch with your supplier.
- 3 - The product must not be modified. Any change will nullify the safety guarantees and may make the luminaire dangerous.
- 4 - Rotaliana declines all responsibility for damage caused to things or persons by any improper use of the luminaire.
- 5 - Refer to the website www.rotaliana.it for instruction on how to disassemble the product at the end of its lifecycle.

FR

- 1 - Suivre soigneusement les instructions de montage et utilisation pour garantir un correct et sûr fonctionnement de l'appareil.
- 2 - Garder les Instructions pour des futures nécessités. Pour tous problèmes, contacter le revendeur.
- 3 - Le produit ne doit pas être modifié. Toute modification annule les approbations de sécurité et peut rendre dangereux l'appareil.
- 4 - Rotaliana décline toute responsabilité pour les dégats causés par des personnes à un incorrecte utilisation de l'appareil.
- 5 - Reportez-vous au site www.rotaliana.it pour les instructions de le démontage du produit en fin de vie.

DE

- 1 - Bitte lesen Sie die Montage- und Gebrauchsanleitungen aufmerksam, um eine richtige und gefahrlose Arbeitsweise der Leuchte zu gewährleisten.
- 2 - Bewahren Sie die Anweisungen für zukünftige Notfälle auf.
- 3 - Das Produkt darf nicht verändert werden. Jede Änderung annulliert die Sicherheitsbestimmungen und könnte zu einer Gefährdung durch die Leuchte führen.
- 4 - Rotaliana ist nicht für Schäden verantwortlich, die durch Dritte bei unsachgemäßer Anwendung der Leuchte verursacht werden.
- 5 - Für die Demontage am Ende der Lebensdauer des Produkts konsultieren Sie bitte die Website www.rotaliana.it.

Rotaliana srl
via Trento 115 - 117
38017 Mezzolombardo
Trento, Italia

T. +39 0461 602376
info@rotaliana.it
rotaliana.it

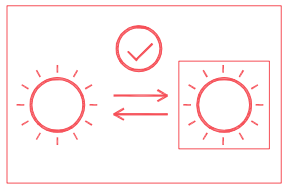

IT- Sorgente luminosa sostituibile dall'utente.

EN- Replaceable light source by an end-user.

FR- Source de lumière remplaçable par un usager final.

DE- Durch einen Endbenutzer austauschbare Lichtquelle.

A Brand of Mezzalana Investment Group
www.mig.it

Flow Glass design: Dante Donegani & Giovanni Lauda

Made in Italy

IT
EN
FR
DE
UE

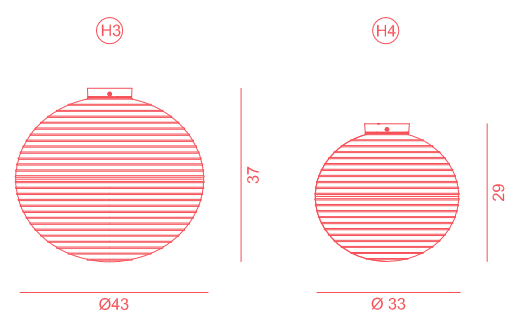
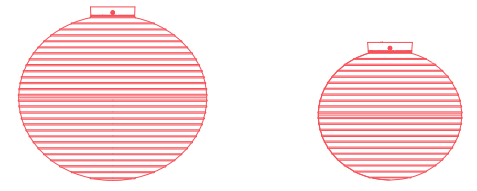

Light Source 1 x E27 LED

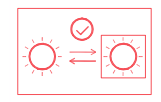

LED IP 20

LED IP 20

LED IP 20

LED IP 20

IP20 Indice di protezione IP 20. Protezione contro l'ingresso di corpi solidi di Ø 12 mm. Nessuna protezione contro la pioggia. Marcatura non prevista sull'apparecchio.

IP20 Le parti che conducono corrente non devono entrare in contatto con l'umidità. Le superfici quali paralumi, vetri, riflettori e coperture possono essere pulite con un panno morbido senza detersivo. Proteggere la lampada dall'umidità durante l'uso.

IP20 Protection against contact with solid bodies of Ø ≥ 12 mm. No protection is provided on the luminaire.

IP20 Parts that conduct current must not be exposed to humidity. Surfaces such as lampshades, glasses, reflectors and covers can be cleaned with a soft cloth but without using detergents.

IP20 Index de protection IP 20. Protection des éléments conducteurs accessibles n'a aucune protection contre la pluie. Il est recommandé de nettoyer les surfaces avec un tissu souple sans détergent. Protéger l'appareil contre l'humidité pendant son utilisation.

IP20 Les parties qui conduisent le courant électrique ne doivent jamais entrer en contact avec l'humidité. Les surfaces comme abat-jours, verres, réflecteurs et couvercles peuvent être nettoyés avec un tissu souple sans détergent. Protéger l'appareil contre l'humidité pendant son utilisation.

IP20 Schutzart IP 20. Schutz gegen Regenwasser. Ø12 mm. Kein Schutz gegen Stromleitende Teile dürfen nicht und Abdeckungen können mit einem weichen Tuch ohne Reinigungsmittel gereinigt werden. Die Lampe gegen Feuchtigkeit schützen.

IP20 ACHTUNG Das Gerät darf nicht als unsortierter Stedlungsabfall entsorgt werden. Zum Schutz der Umwelt muss es getrennt einer Sammelstelle abgegeben werden. Gemäß der Richtlinie 2012/19/UE und den entsprechenden nationalen Gesetzen über die Entsorgung von Altgeräten ist die Nichtenthaltung strafbar. Bitte informieren Sie sich über die örtlichen Sammelstellen für Elektroprodukte und elektronische Geräte.

IP20 Das LED-Modul in dieser Leuchte enthält das nur vom Hersteller ersetzt werden. Für weitere Informationen, wenden Sie sich bitte an Ihren Lieferanten.

IP20 La source lumineuse contenue dans ce appareil peut être échangée seulement par le constructeur. Merci de contacter le service commercial pour toutes les informations.

IP20 The LED module contained in this luminaire shall only be replaced by the manufacturer. For further informations, please contact your supplier.

IP20 The local separate collection system for electrical and electronic products.

IP20 In this luminaire is sanctioned disposal of waste at the end of the life cycle adopted pursuant to this Directive on the procedures of Directive 2012/19/UE and relevant national laws and regulations environmental impacts. In accordance with collected separately to prevent negative municipal waste. It must be disposed as unsorted.

IP20 ATTENTION The product cannot be disposed as unsorted.

IP20 Installation and maintenance must be performed exclusively by specialised personnel.

IP20 The LED module contained in this luminaire shall only be replaced by the manufacturer. For further informations, please contact your supplier.

IP20 The local separate collection system for electrical and electronic products.

IP20 In this luminaire is sanctioned disposal of waste at the end of the life cycle adopted pursuant to this Directive on the procedures of Directive 2012/19/UE and relevant national laws and regulations environmental impacts. In accordance with collected separately to prevent negative municipal waste. It must be disposed as unsorted.

IP20 ATTENTION The product cannot be disposed as unsorted.

IP20 Installation and maintenance must be performed exclusively by specialised personnel.

IP20 The LED module contained in this luminaire shall only be replaced by the manufacturer. For further informations, please contact your supplier.

IP20 The local separate collection system for electrical and electronic products.

IP20 In this luminaire is sanctioned disposal of waste at the end of the life cycle adopted pursuant to this Directive on the procedures of Directive 2012/19/UE and relevant national laws and regulations environmental impacts. In accordance with collected separately to prevent negative municipal waste. It must be disposed as unsorted.

IP20 ATTENTION The product cannot be disposed as unsorted.

IP20 Installation and maintenance must be performed exclusively by specialised personnel.

IP20 The LED module contained in this luminaire shall only be replaced by the manufacturer. For further informations, please contact your supplier.

IP20 The local separate collection system for electrical and electronic products.

IP20 Indice di protezione IP 20. Protezione contro l'ingresso di corpi solidi di Ø 12 mm. Nessuna protezione contro la pioggia. Marcatura non prevista sull'apparecchio.

IP20 Le parti che conducono corrente non devono entrare in contatto con l'umidità. Le superfici quali paralumi, vetri, riflettori e coperture possono essere pulite con un panno morbido senza detersivo. Proteggere la lampada dall'umidità durante l'uso.

IP20 Protection against contact with solid bodies of Ø ≥ 12 mm. No protection is provided on the luminaire.

IP20 Parts that conduct current must not be exposed to humidity. Surfaces such as lampshades, glasses, reflectors and covers can be cleaned with a soft cloth but without using detergents.

IP20 Index de protection IP 20. Protection des éléments conducteurs accessibles n'a aucune protection contre la pluie. Il est recommandé de nettoyer les surfaces avec un tissu souple sans détergent. Protéger l'appareil contre l'humidité pendant son utilisation.

IP20 Les parties qui conduisent le courant électrique ne doivent jamais entrer en contact avec l'humidité. Les surfaces comme abat-jours, verres, réflecteurs et couvercles peuvent être nettoyés avec un tissu souple sans détergent. Protéger l'appareil contre l'humidité pendant son utilisation.

IP20 Schutzart IP 20. Schutz gegen Regenwasser. Ø12 mm. Kein Schutz gegen Stromleitende Teile dürfen nicht und Abdeckungen können mit einem weichen Tuch ohne Reinigungsmittel gereinigt werden. Die Lampe gegen Feuchtigkeit schützen.

IP20 ACHTUNG Das Gerät darf nicht als unsortierter Stedlungsabfall entsorgt werden. Zum Schutz der Umwelt muss es getrennt einer Sammelstelle abgegeben werden. Gemäß der Richtlinie 2012/19/UE und den entsprechenden nationalen Gesetzen über die Entsorgung von Altgeräten ist die Nichtenthaltung strafbar. Bitte informieren Sie sich über die örtlichen Sammelstellen für Elektroprodukte und elektronische Geräte.

IP20 Das LED-Modul in dieser Leuchte enthält das nur vom Hersteller ersetzt werden. Für weitere Informationen, wenden Sie sich bitte an Ihren Lieferanten.

IP20 La source lumineuse contenue dans ce appareil peut être échangée seulement par le constructeur. Merci de contacter le service commercial pour toutes les informations.

IP20 The LED module contained in this luminaire shall only be replaced by the manufacturer. For further informations, please contact your supplier.

IP20 The local separate collection system for electrical and electronic products.

IP20 In this luminaire is sanctioned disposal of waste at the end of the life cycle adopted pursuant to this Directive on the procedures of Directive 2012/19/UE and relevant national laws and regulations environmental impacts. In accordance with collected separately to prevent negative municipal waste. It must be disposed as unsorted.

IP20 ATTENTION The product cannot be disposed as unsorted.

IP20 Installation and maintenance must be performed exclusively by specialised personnel.

IP20 The LED module contained in this luminaire shall only be replaced by the manufacturer. For further informations, please contact your supplier.

IP20 The local separate collection system for electrical and electronic products.

IP20 In this luminaire is sanctioned disposal of waste at the end of the life cycle adopted pursuant to this Directive on the procedures of Directive 2012/19/UE and relevant national laws and regulations environmental impacts. In accordance with collected separately to prevent negative municipal waste. It must be disposed as unsorted.

IP20 ATTENTION The product cannot be disposed as unsorted.

IP20 Installation and maintenance must be performed exclusively by specialised personnel.

IP20 The LED module contained in this luminaire shall only be replaced by the manufacturer. For further informations, please contact your supplier.

IP20 The local separate collection system for electrical and electronic products.

IP20 Indice di protezione IP 20. Protezione contro l'ingresso di corpi solidi di Ø 12 mm. Nessuna protezione contro la pioggia. Marcatura non prevista sull'apparecchio.

IP20 Le parti che conducono corrente non devono entrare in contatto con l'umidità. Le superfici quali paralumi, vetri, riflettori e coperture possono essere pulite con un panno morbido senza detersivo. Proteggere la lampada dall'umidità durante l'uso.

IP20 Protection against contact with solid bodies of Ø ≥ 12 mm. No protection is provided on the luminaire.

IP20 Parts that conduct current must not be exposed to humidity. Surfaces such as lampshades, glasses, reflectors and covers can be cleaned with a soft cloth but without using detergents.

IP20 Index de protection IP 20. Protection des éléments conducteurs accessibles n'a aucune protection contre la pluie. Il est recommandé de nettoyer les surfaces avec un tissu souple sans détergent. Protéger l'appareil contre l'humidité pendant son utilisation.

IP20 Les parties qui conduisent le courant électrique ne doivent jamais entrer en contact avec l'humidité. Les surfaces comme abat-jours, verres, réflecteurs et couvercles peuvent être nettoyés avec un tissu souple sans détergent. Protéger l'appareil contre l'humidité pendant son utilisation.

IP20 Schutzart IP 20. Schutz gegen Regenwasser. Ø12 mm. Kein Schutz gegen Stromleitende Teile dürfen nicht und Abdeckungen können mit einem weichen Tuch ohne Reinigungsmittel gereinigt werden. Die Lampe gegen Feuchtigkeit schützen.

IP20 ACHTUNG Das Gerät darf nicht als unsortierter Stedlungsabfall entsorgt werden. Zum Schutz der Umwelt muss es getrennt einer Sammelstelle abgegeben werden. Gemäß der Richtlinie 2012/19/UE und den entsprechenden nationalen Gesetzen über die Entsorgung von Altgeräten ist die Nichtenthaltung strafbar. Bitte informieren Sie sich über die örtlichen Sammelstellen für Elektroprodukte und elektronische Geräte.

IP20 Das LED-Modul in dieser Leuchte enthält das nur vom Hersteller ersetzt werden. Für weitere Informationen, wenden Sie sich bitte an Ihren Lieferanten.

IP20 La source lumineuse contenue dans ce appareil peut être échangée seulement par le constructeur. Merci de contacter le service commercial pour toutes les informations.

IP20 The LED module contained in this luminaire shall only be replaced by the manufacturer. For further informations, please contact your supplier.

IP20 The local separate collection system for electrical and electronic products.

IP20 In this luminaire is sanctioned disposal of waste at the end of the life cycle adopted pursuant to this Directive on the procedures of Directive 2012/19/UE and relevant national laws and regulations environmental impacts. In accordance with collected separately to prevent negative municipal waste. It must be disposed as unsorted.

IP20 ATTENTION The product cannot be disposed as unsorted.

IP20 Installation and maintenance must be performed exclusively by specialised personnel.

IP20 The LED module contained in this luminaire shall only be replaced by the manufacturer. For further informations, please contact your supplier.

IP20 The local separate collection system for electrical and electronic products.

IP20 In this luminaire is sanctioned disposal of waste at the end of the life cycle adopted pursuant to this Directive on the procedures of Directive 2012/19/UE and relevant national laws and regulations environmental impacts. In accordance with collected separately to prevent negative municipal waste. It must be disposed as unsorted.

IP20 ATTENTION The product cannot be disposed as unsorted.

IP20 Installation and maintenance must be performed exclusively by specialised personnel.

IP20 The LED module contained in this luminaire shall only be replaced by the manufacturer. For further informations, please contact your supplier.

IP20 The local separate collection system for electrical and electronic products.

IP20 Indice di protezione IP 20. Protezione contro l'ingresso di corpi solidi di Ø 12 mm. Nessuna protezione contro la pioggia. Marcatura non prevista sull'apparecchio.

IP20 Le parti che conducono corrente non devono entrare in contatto con l'umidità. Le superfici quali paralumi, vetri, riflettori e coperture possono essere pulite con un panno morbido senza detersivo. Proteggere la lampada dall'umidità durante l'uso.

IP20 Protection against contact with solid bodies of Ø ≥ 12 mm. No protection is provided on the luminaire.

IP20 Parts that conduct current must not be exposed to humidity. Surfaces such as lampshades, glasses, reflectors and covers can be cleaned with a soft cloth but without using detergents.

IP20 Index de protection IP 20. Protection des éléments conducteurs accessibles n'a aucune protection contre la pluie. Il est recommandé de nettoyer les surfaces avec un tissu souple sans détergent. Protéger l'appareil contre l'humidité pendant son utilisation.

IP20 Les parties qui conduisent le courant électrique ne doivent jamais entrer en contact avec l'humidité. Les surfaces comme abat-jours, verres, réflecteurs et couvercles peuvent être nettoyés avec un tissu souple sans détergent. Protéger l'appareil contre l'humidité pendant son utilisation.

IP20 Schutzart IP 20. Schutz gegen Regenwasser. Ø12 mm. Kein Schutz gegen Stromleitende Teile dürfen nicht und Abdeckungen können mit einem weichen Tuch ohne Reinigungsmittel gereinigt werden. Die Lampe gegen Feuchtigkeit schützen.

IP20 ACHTUNG Das Gerät darf nicht als unsortierter Stedlungsabfall entsorgt werden. Zum Schutz der Umwelt muss es getrennt einer Sammelstelle abgegeben werden. Gemäß der Richtlinie 2012/19/UE und den entsprechenden nationalen Gesetzen über die Entsorgung von Altgeräten ist die Nichtenthaltung strafbar. Bitte informieren Sie sich über die örtlichen Sammelstellen für Elektroprodukte und elektronische Geräte.

IP20 Das LED-Modul in dieser Leuchte enthält das nur vom Hersteller ersetzt werden. Für weitere Informationen, wenden Sie sich bitte an Ihren Lieferanten.

IP20 La source lumineuse contenue dans ce appareil peut être échangée seulement par le constructeur. Merci de contacter le service commercial pour toutes les informations.

IP20 The LED module contained in this luminaire shall only be replaced by the manufacturer. For further informations, please contact your supplier.

IP20 The local separate collection system for electrical and electronic products.

IP20 In this luminaire is sanctioned disposal of waste at the end of the life cycle adopted pursuant to this Directive on the procedures of Directive 2012/19/UE and relevant national laws and regulations environmental impacts. In accordance with collected separately to prevent negative municipal waste. It must be disposed as unsorted.

IP20 ATTENTION The product cannot be disposed as unsorted.

IP20 Installation and maintenance must be performed exclusively by specialised personnel.

IP20 The LED module contained in this luminaire shall only be replaced by the manufacturer. For further informations, please contact your supplier.

IP20 The local separate collection system for electrical and electronic products.

IP20 In this luminaire is sanctioned disposal of waste at the end of the life cycle adopted pursuant to this Directive on the procedures of Directive 2012/19/UE and relevant national laws and regulations environmental impacts. In accordance with collected separately to prevent negative municipal waste. It must be disposed as unsorted.

IP20 ATTENTION The product cannot be disposed as unsorted.

IP20 Installation and maintenance must be performed exclusively by specialised personnel.

IP20 The LED module contained in this luminaire shall only be replaced by the manufacturer. For further informations, please contact your supplier.

IP20 The local separate collection system for electrical and electronic products.

Tensione di funzionamento 220 / 240 V AC 50Hz

Istruzioni di montaggio e uso

UE

IT

Operating voltage 220 / 240 V AC 50Hz

Assembly and operating instructions

UE

EN

Tension 220 / 240 V AC 50Hz

Manuel de montage et mode d'emploi

UE

FR

Betriebsspannung 220 / 240 V AC 50Hz

Montageanleitung und Gebrauchsanweisung

UE

DE

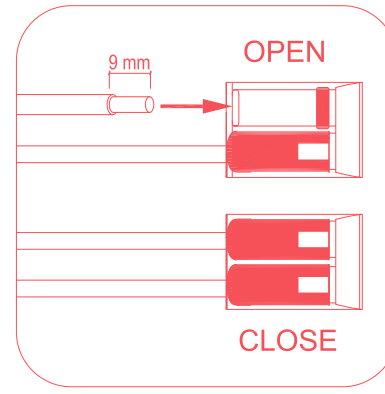
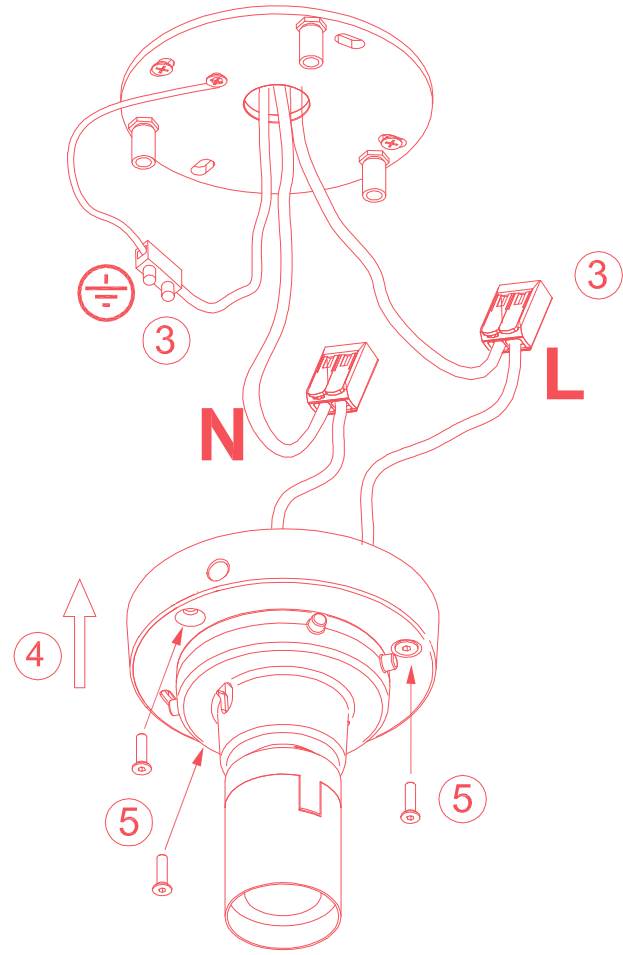
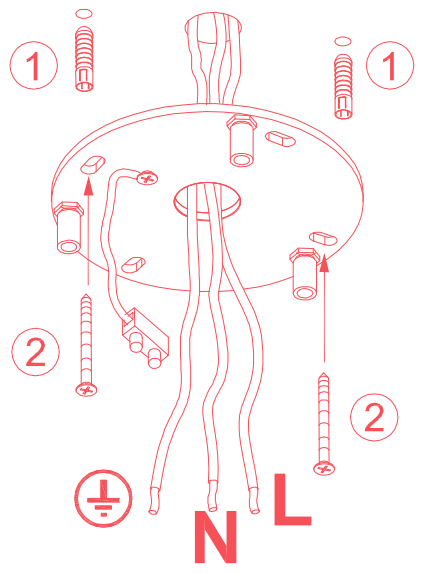

incluso/included

