

Parts List			
Item	Qty	Part Number	Description
1	8	9627158 / 9627159	Linaro 1m Track
2	1	9627176 / 9627177	Linaro End Power Feed
3	2	10024642 / 10024643	Linaro End Cap
4	7	9627164 / 9627165	Linaro Straight Connector
5	1	9627161 / 9627162	Linaro Middle Power Feed
6	2	9627167 / 9627168	Linaro 90° Connector
7	14	9627146 / 9627147	Linaro GU10 Spot

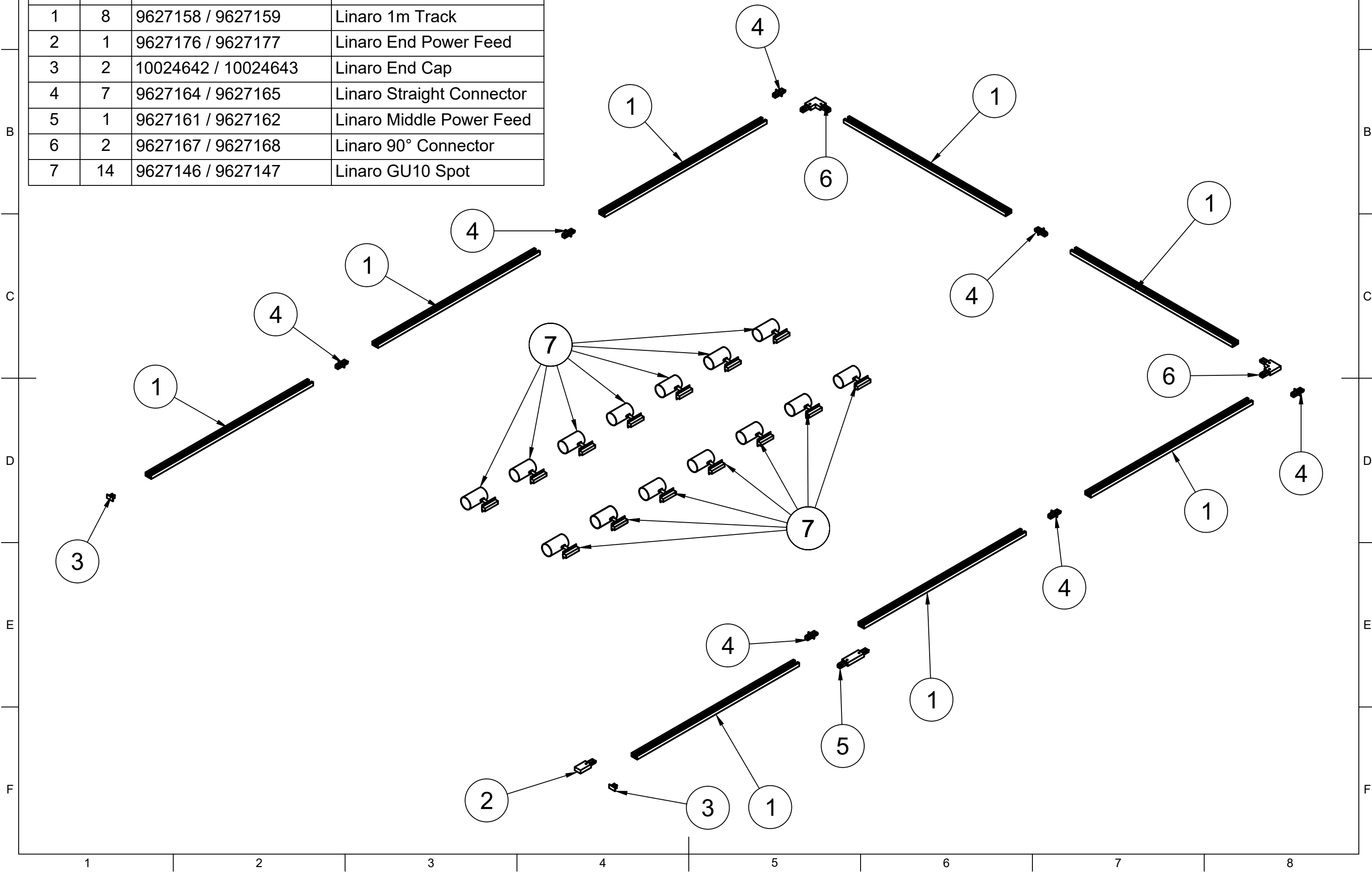

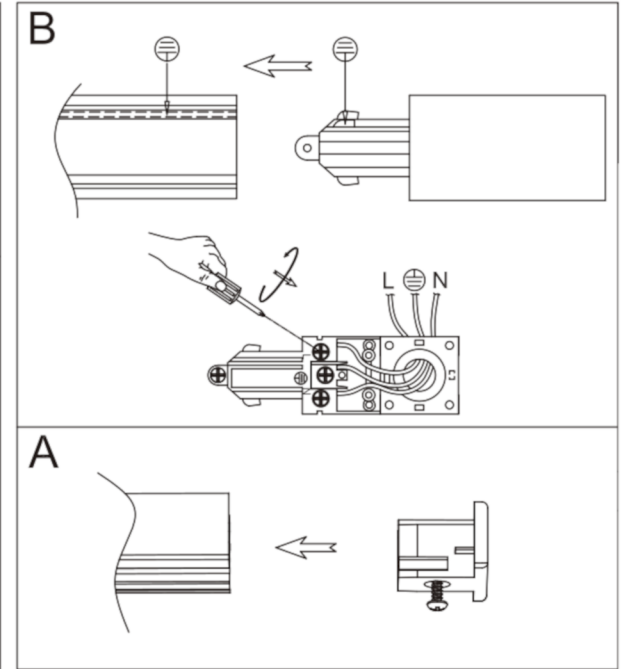

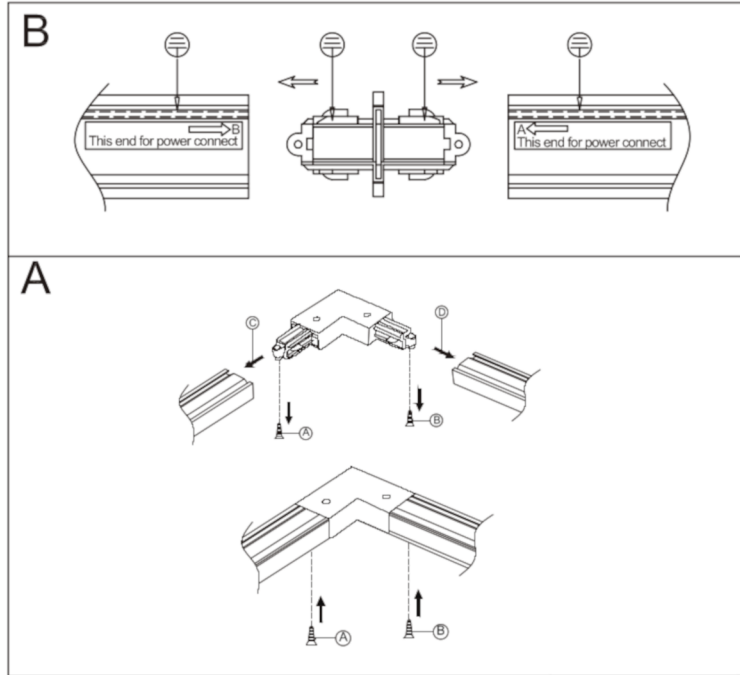
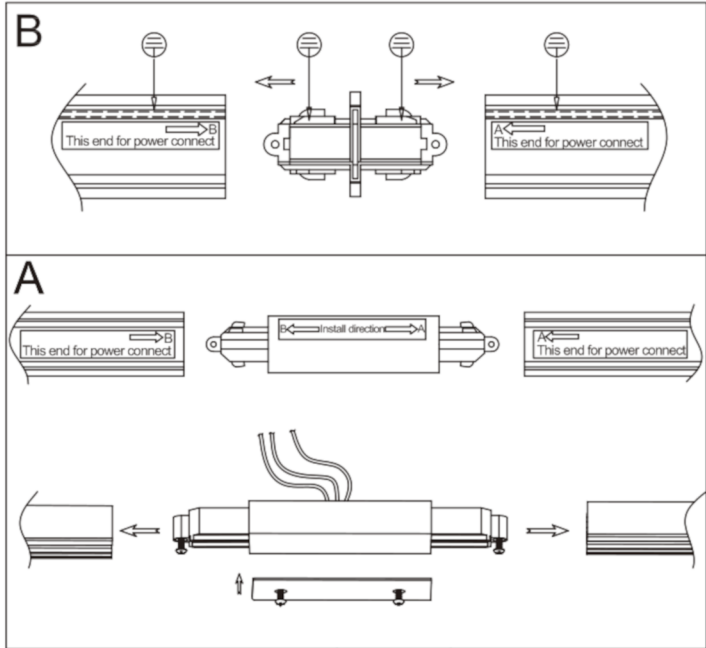
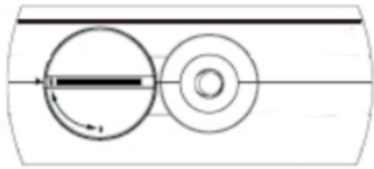

Please check the diection.  
Earth connection is only given  
when line on the base of the  
spot is on the same side as the  
line on the track

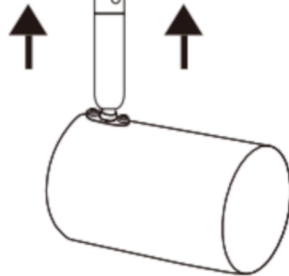

Example Spot

unlocked



Example Spot

locked

