



# INSTALLATION INSTRUCTIONS EN

The advice of a qualified person may be required for installation.  
 The product can be used outdoors if the luminaire shows the symbol IP44 or IP54, otherwise the product should only be used indoors. The lighting fitting with wooden elements may be installed only in heated rooms.  
 It is recommended to use a YDY 3 x 1.5 mm<sup>2</sup> power cord with a double sheath.

## RECOMMENDED LIGHT SOURCE: E27, 15W-20W LED BULB

### Installation:



1. Disconnect the power supply.
2. Strip 6 mm of the power supply cables and pass them through the leadthrough of the metal base.
3. Screw the base to the base using appropriately selected screws.
4. Connect the power cables to the appropriately marked terminals on in the connector - brown phase conductors (L1, L2) and blue neutral conductor (N). Figure 1. If the cube is equipped with terminals 1 and 2, power can be supplied. Separate the bulbs into two circuits. The jumper should then be pulled out between terminals L1 and L2, and then connect the phase conductors accordingly.
5. Connect the protective earth conductor (usually green and yellow) to the protective terminal marked with the symbol.  Picture 1.
6. Place the glass in the rim with the matte side  down as shown in figure 2.
7. Tightly screw the plastic handles to the rim using the supplied nuts and washers so that the glass is held in place. Under one of the nuts, put the eye of the green-yellow grounding wire screwed to the base. Figure 3. CAUTION! The plastic handles should be screwed in the correct direction (see figure 3).
8. Tighten the rim clockwise (fig. 4). The housing should be screwed on with sufficient force.

The light source used in this luminaire should be replaced only by the manufacturer or its service agent or a similarly qualified person.

### Maintenance:

Maintenance works should be performed with the power supply disconnected and after waiting for the LED panel to cool down.

After disassembling the cover and disconnecting the power supply, clean it with a soft cloth.

	- selective collecting of electrical equipment		
	- luminaire powered by alternating current		- luminaire for ceiling and wall mounting

## 2-year warranty:

1. The warranty covers a period of 2 years from the date of purchase in Poland and is valid only with the purchase document - receipt or invoice.
2. The warranty does not cover damage caused by overvoltage, lightning strikes and mechanical damage.
3. The warranty is valid only if the luminaire has been installed by a person with appropriate electrical qualifications and covers the repair or replacement of the product with a product free from defects or a refund of the amount paid.
4. In the event of a defect, the product should be sent to the following address: Temar sp.z o.o. , 39-300 Mielec, ul. 12 investors or pay back at the point of purchase. The repair should not take more than 14 business days.
5. The guarantee does not exclude, limit or suspend the rights of the buyer resulting from the provisions on the warranty for defects in the sold item.

## 1 15-20W LED E27

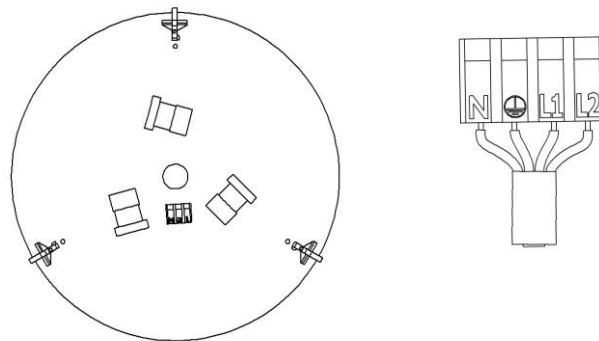

## 2

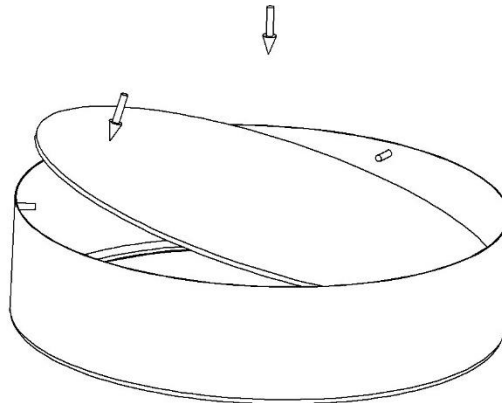

## 3

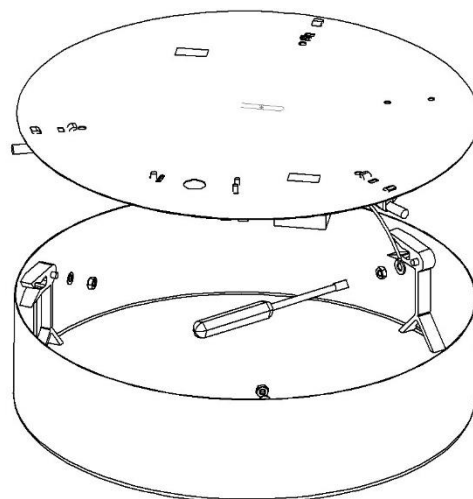
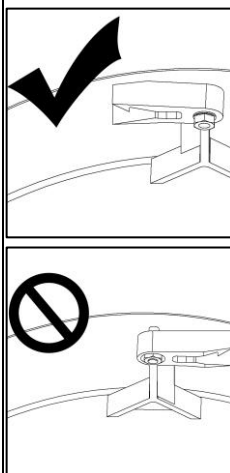

## 4

