

Artemide®

Castore

design
M. De Lucchi / H. Ubbens

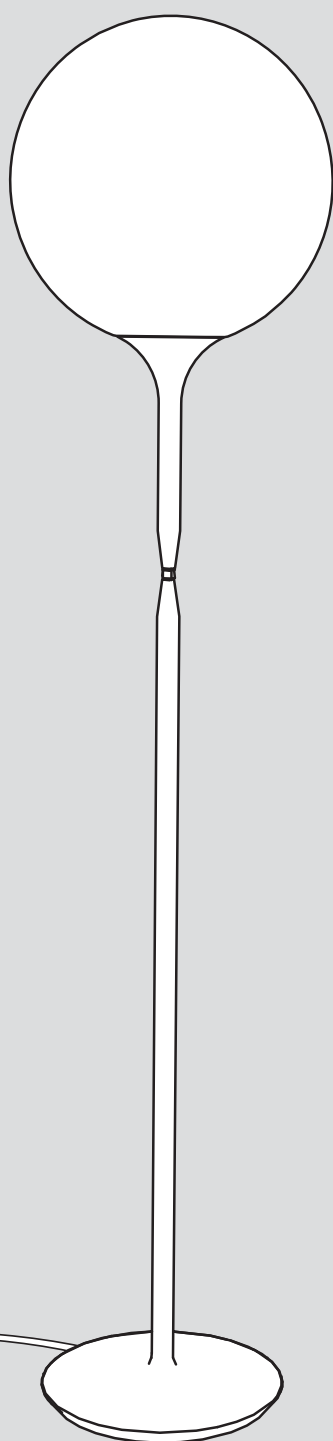



i

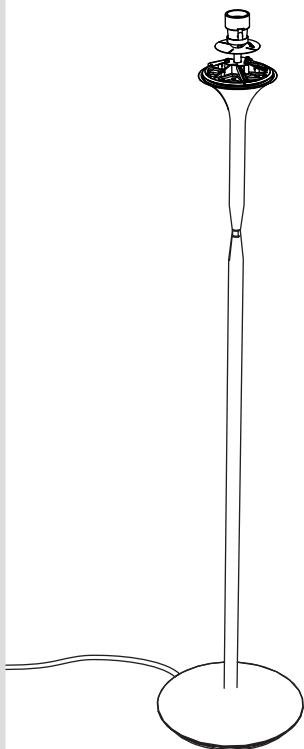
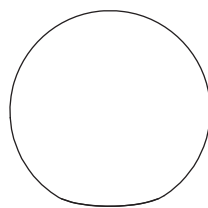
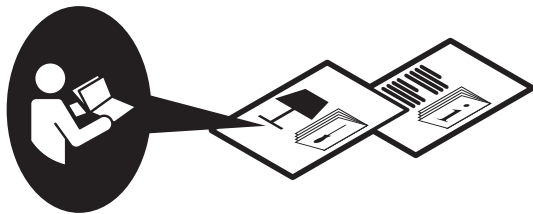
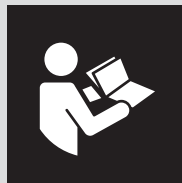
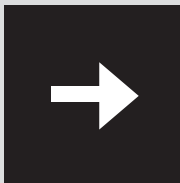
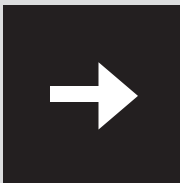
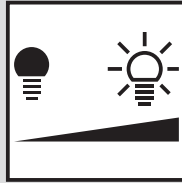
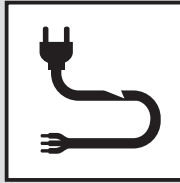
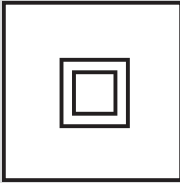

1

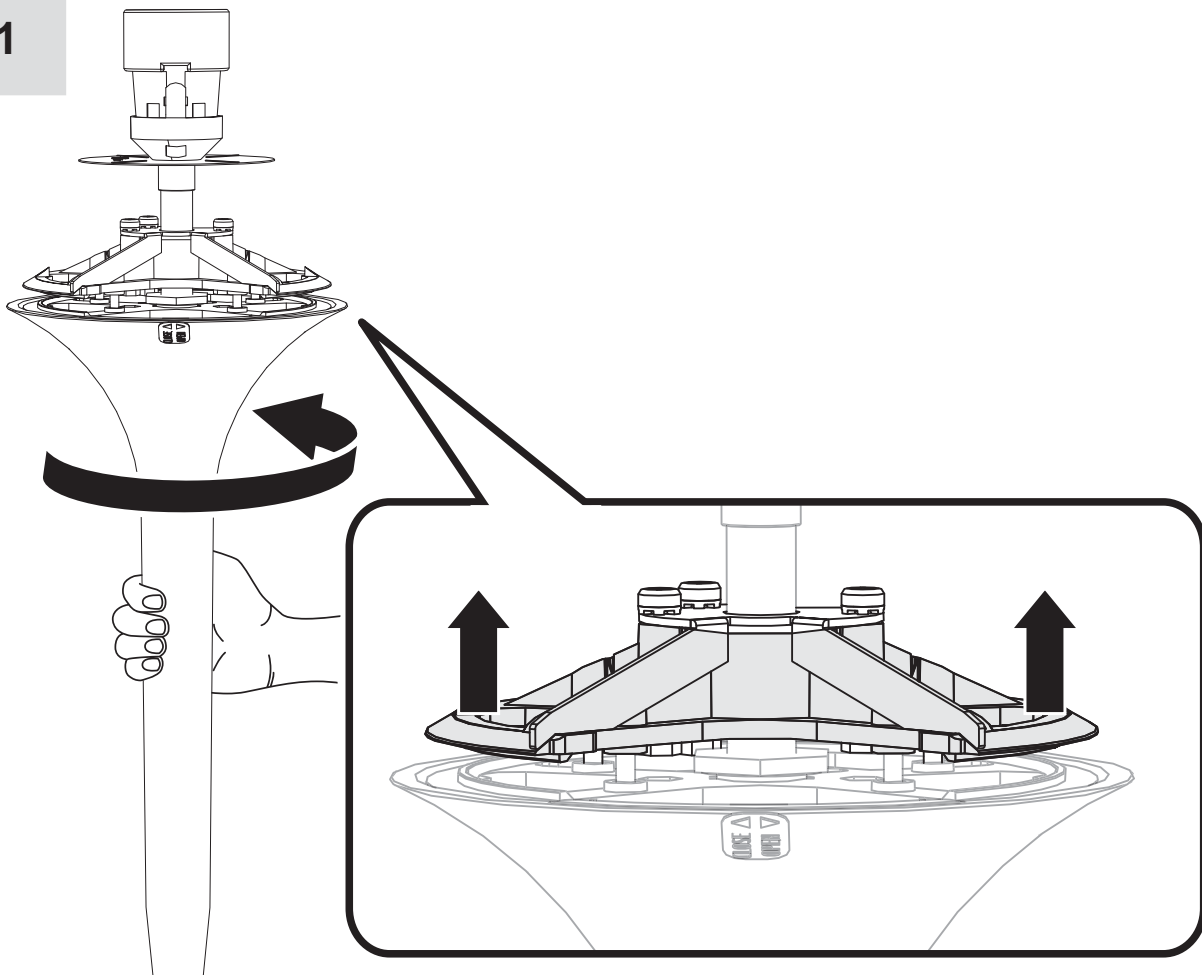

2

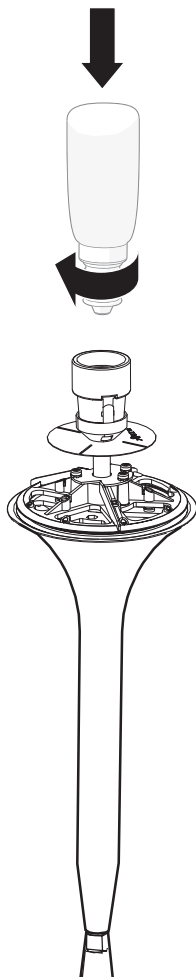

3

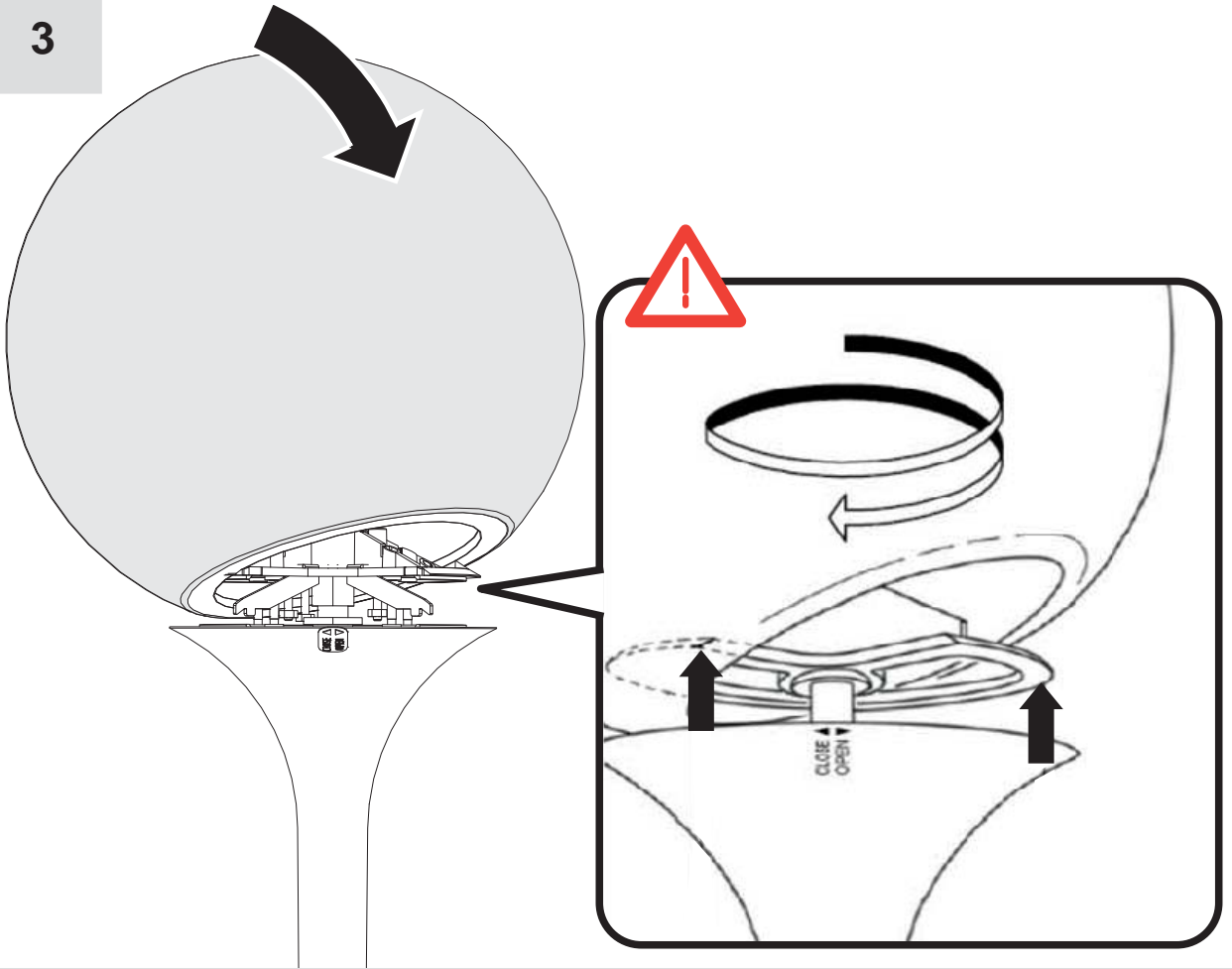

4

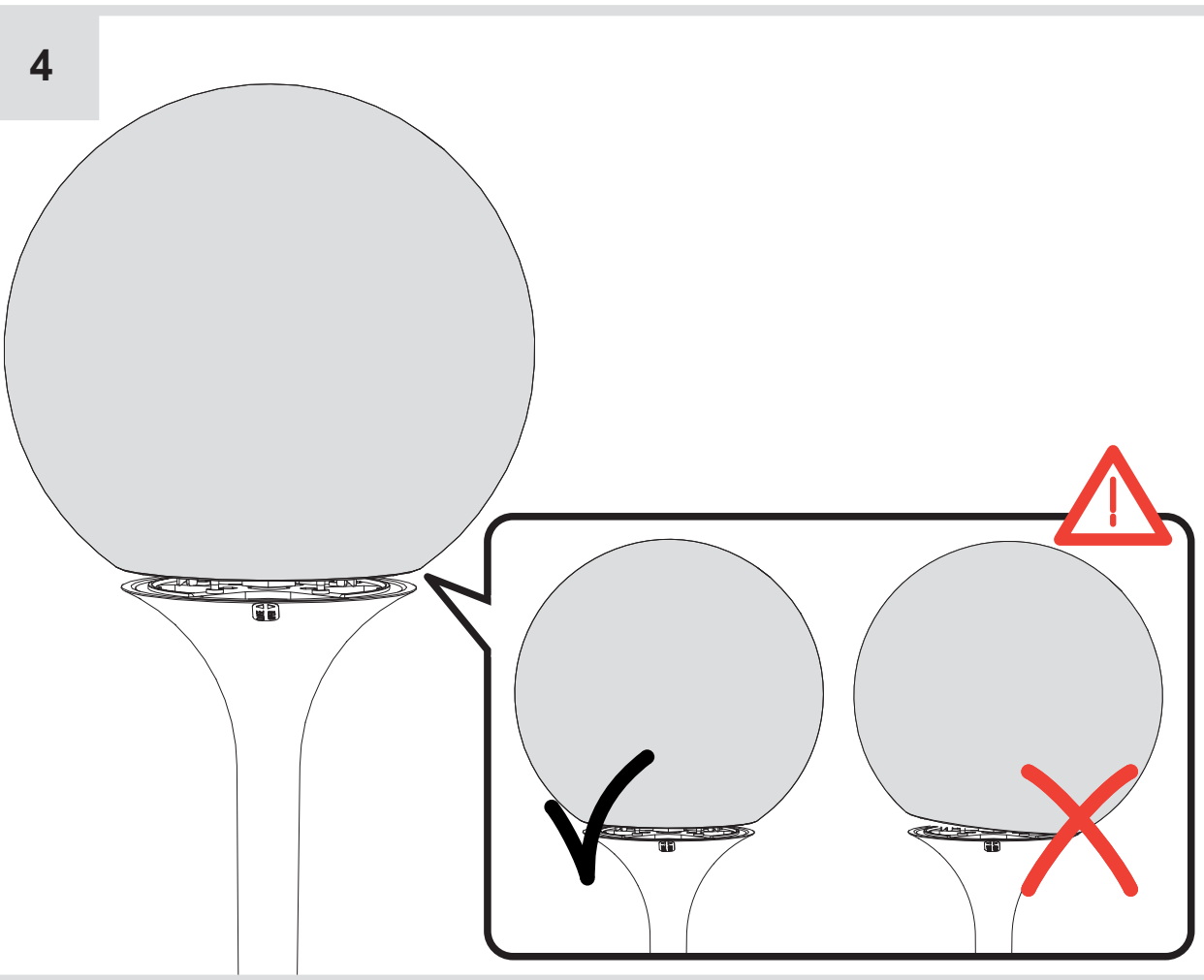

5

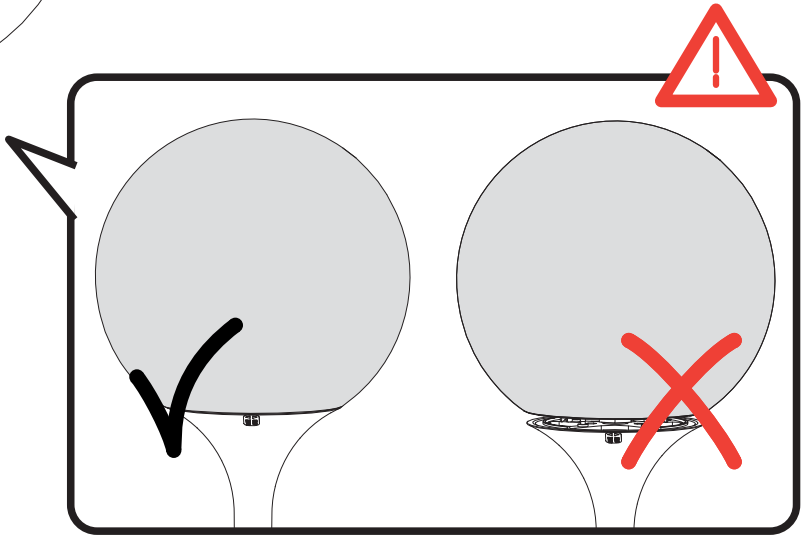
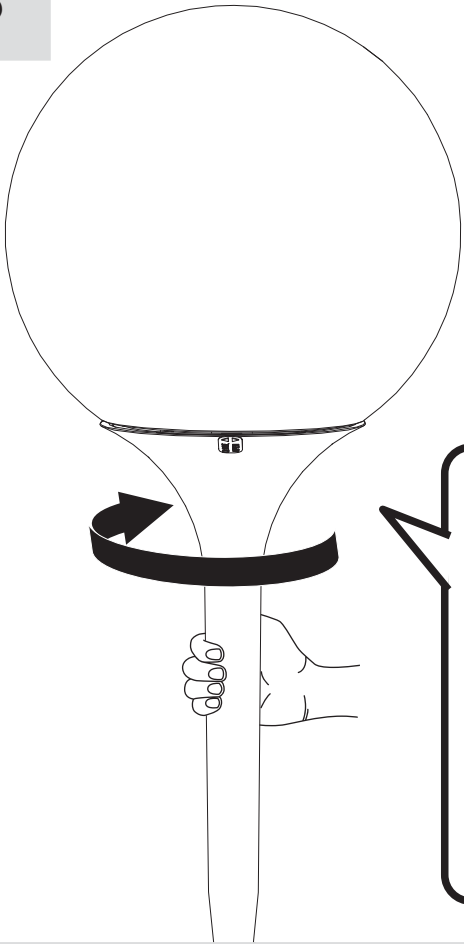

6

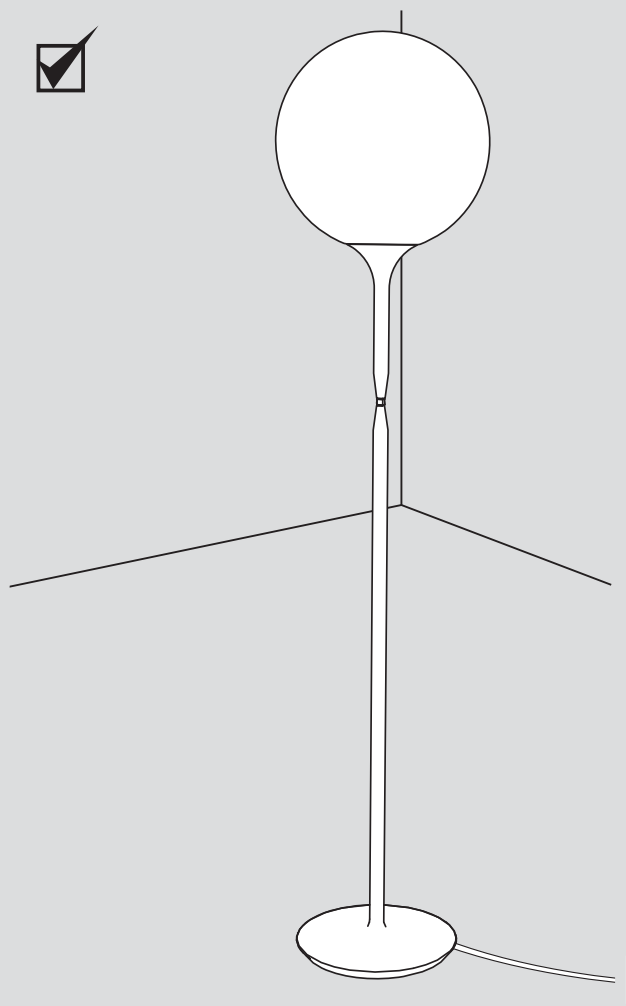
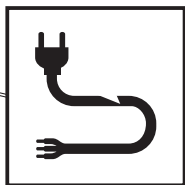
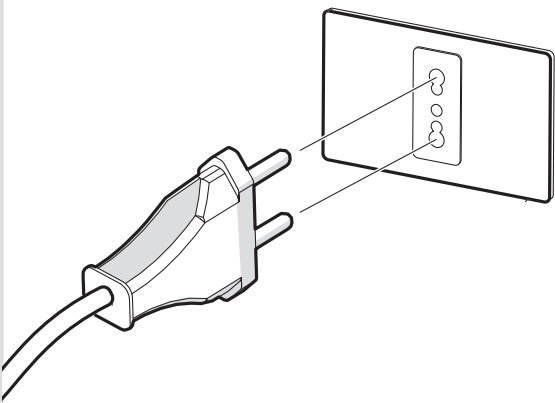



7a

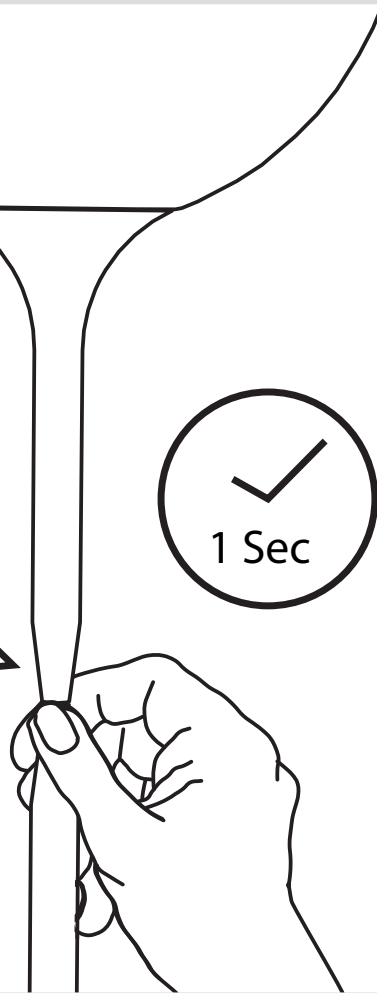
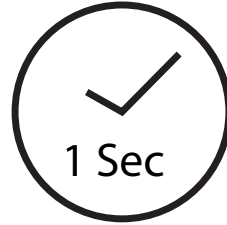
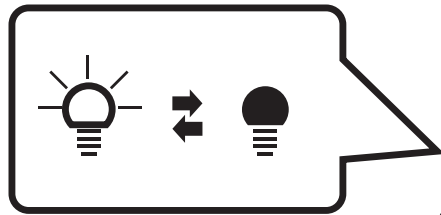

7b

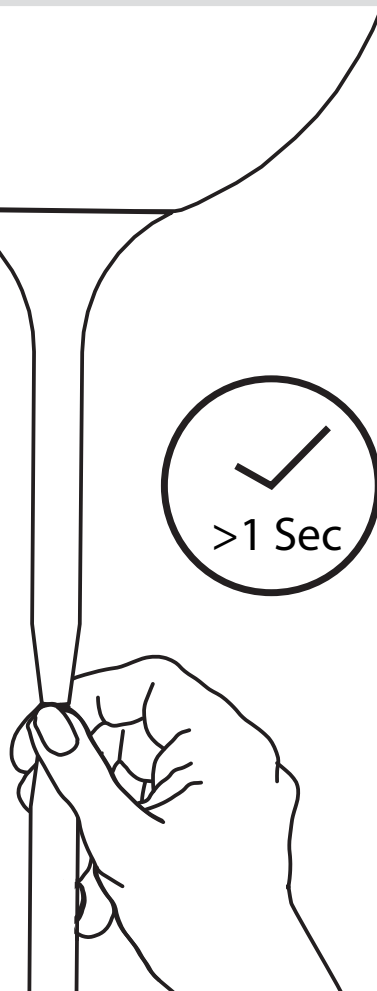
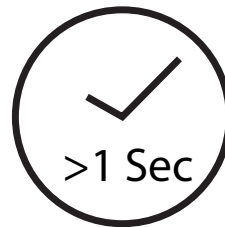
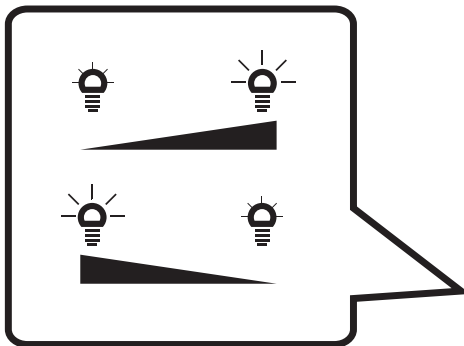

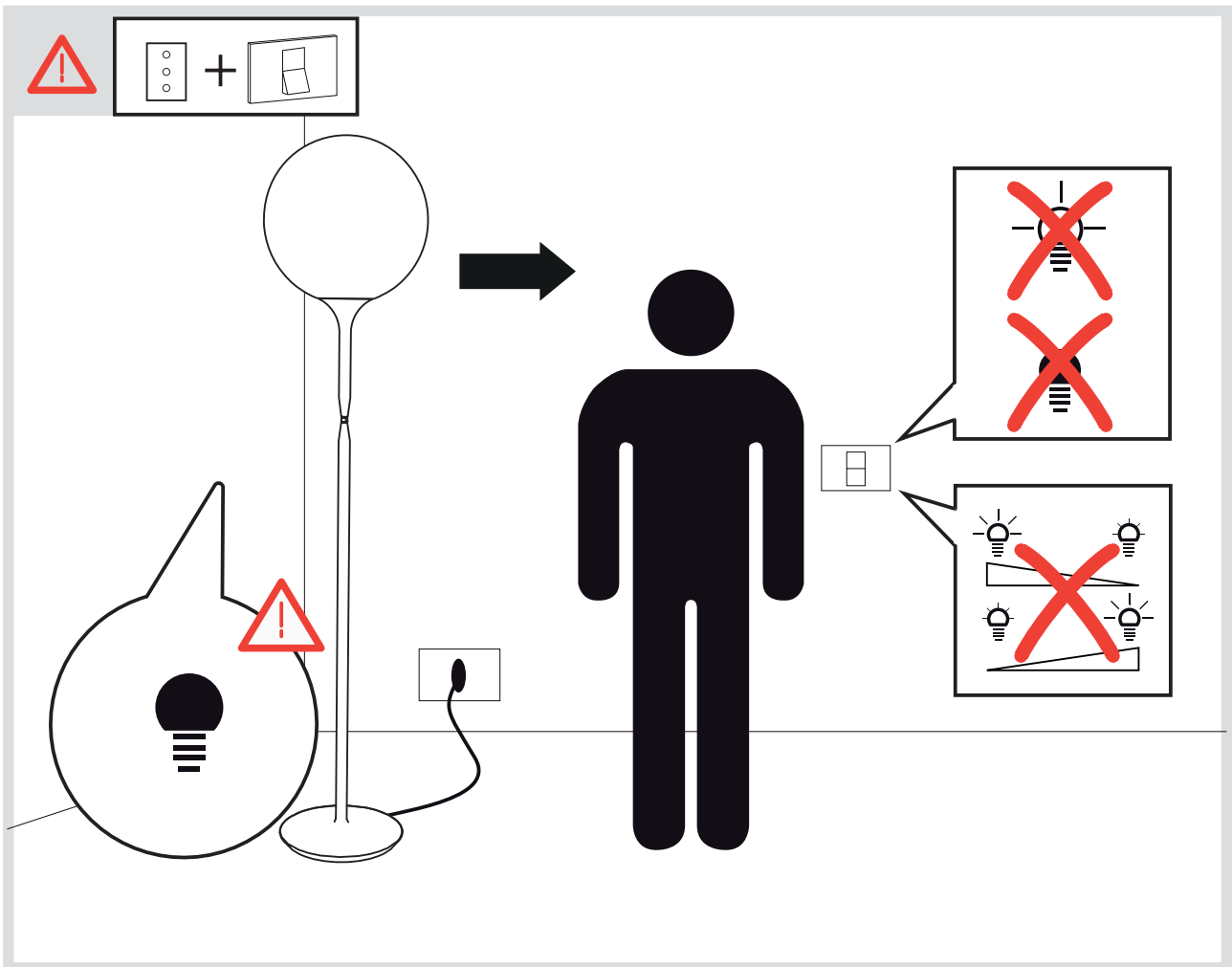
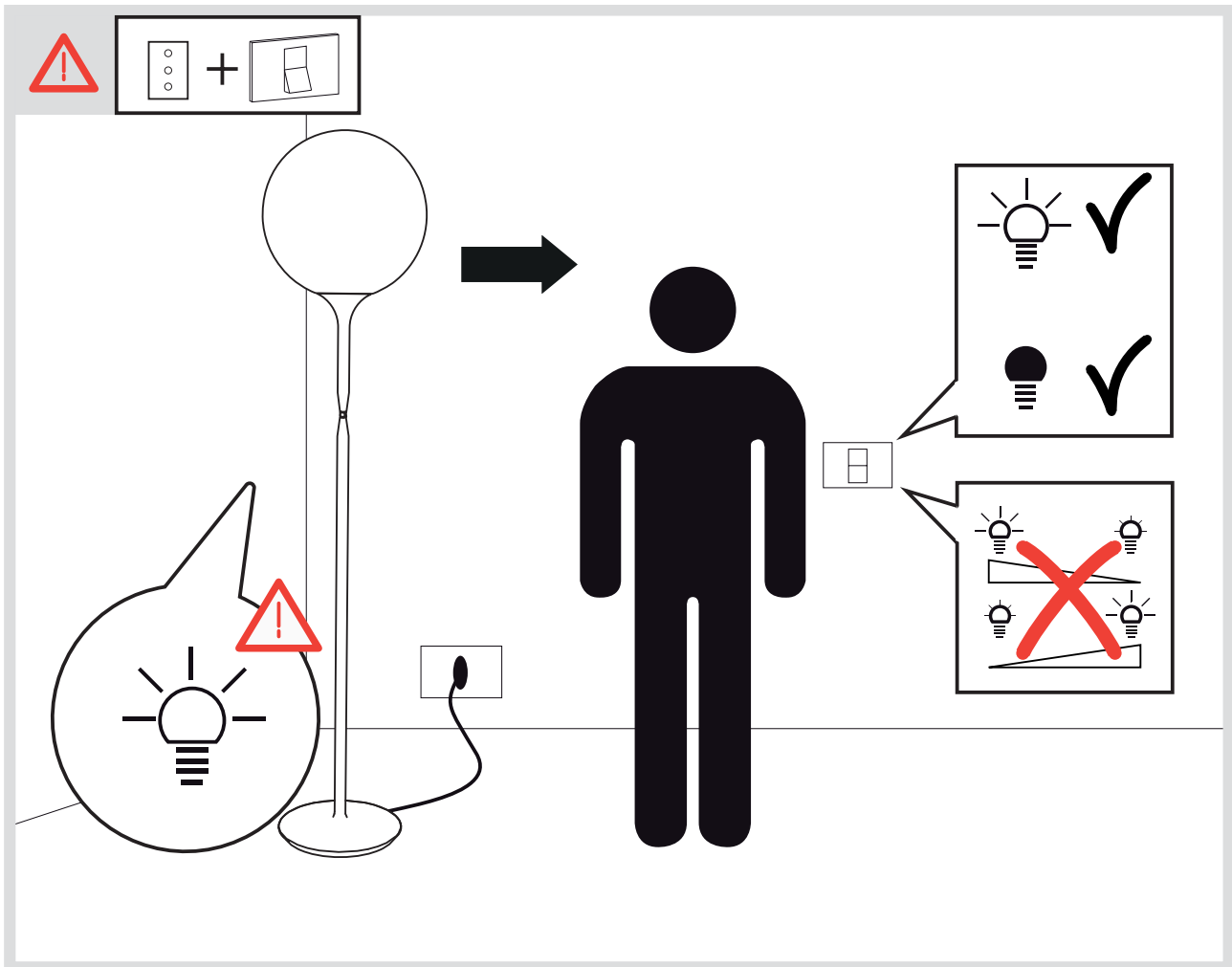



i

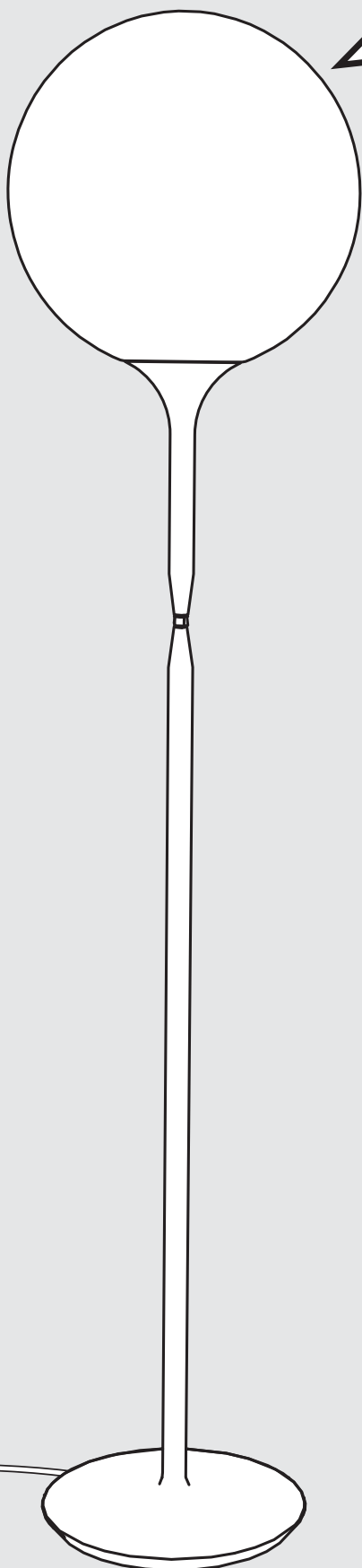

MAX 150W - E27

Halo: HSGST - 2900 lm
LED: DRAA - 2500 lm



MAX 205W - E27

Halo: HSGST - 4200 lm
LED: DRAA - 2500 lm



1

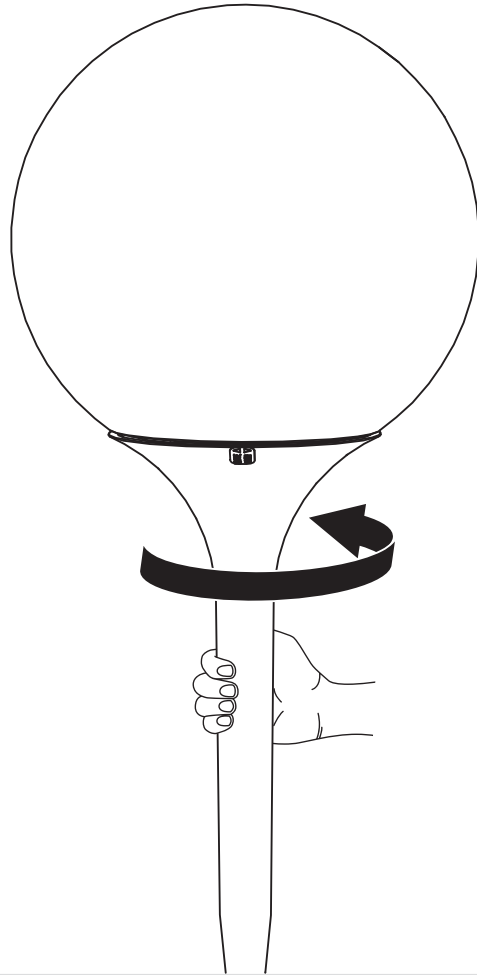

2

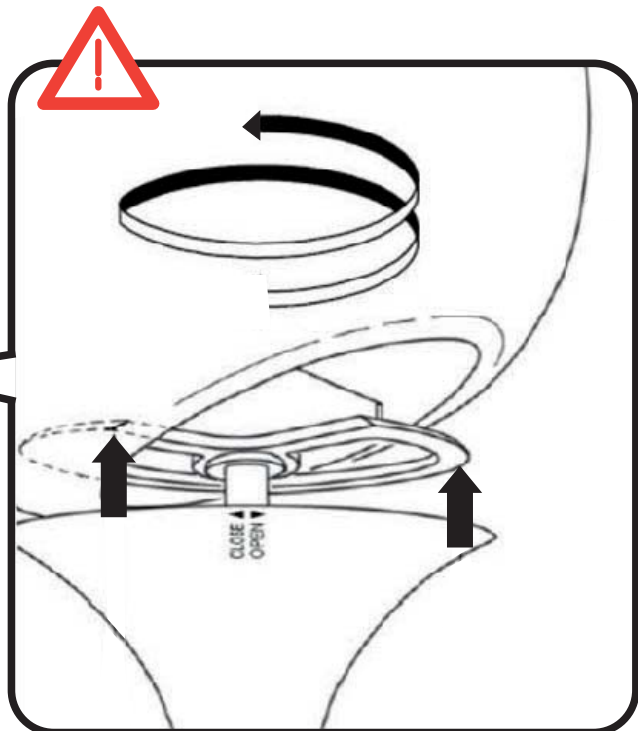
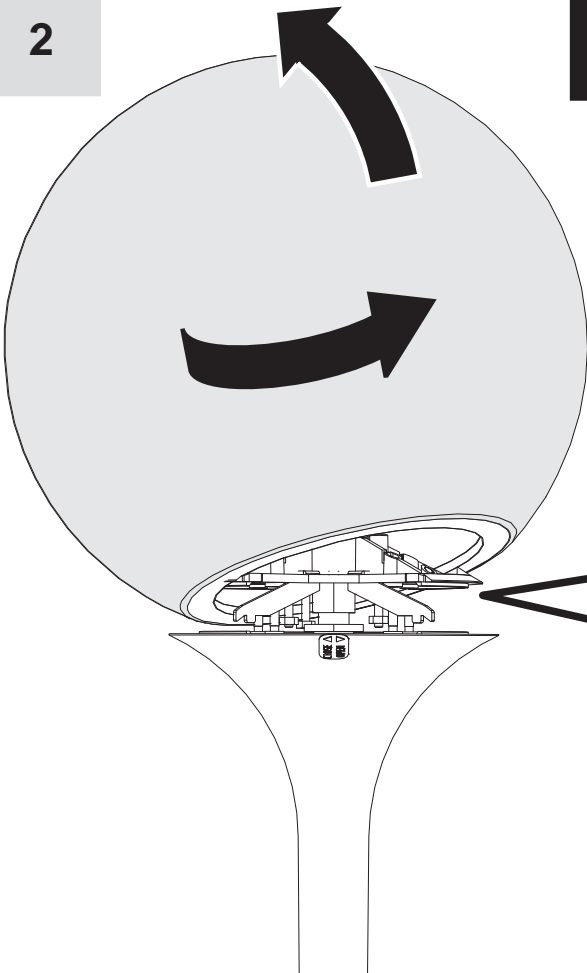
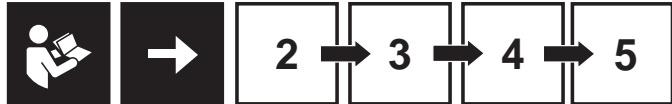

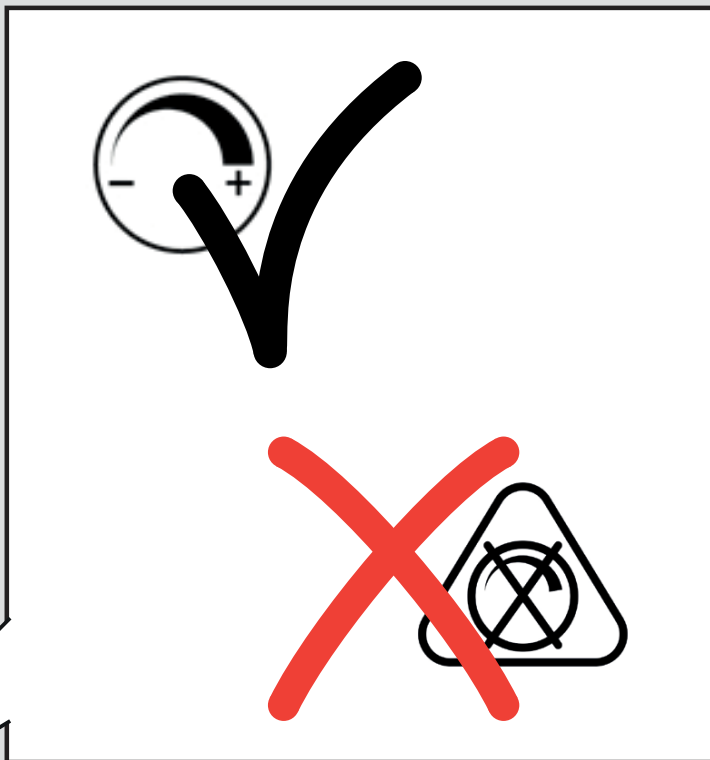
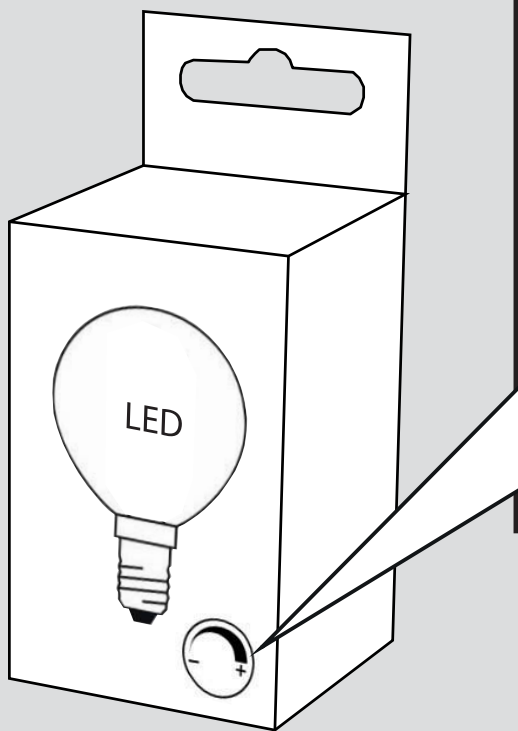

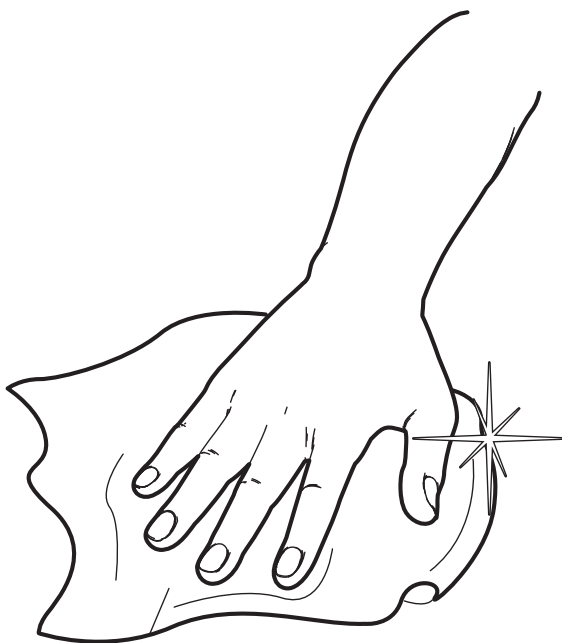

Artemide®



Artemide

via Bergamo, 18
20010 Pregnana M.se (MI)
ITALIA

tel. +39 02 935 181
fax +39 02 935 90 254
fax +39 02 935 90 496

www.artemide.com

VAT IT00846890150

cod. Y513000652