

Artikel Nr.: 930594

Netzgerät, FLAT, CC, UT350mA/12W











IP20 CE

Elektrische Daten

Betriebsart	stromkonstant	Eingangsspannung	220-240V AC/50-60Hz
Leistung	0,70-12,00 W	Leistungsfaktor	0,50C
Ausgangsspannung	2-35V DC	Anschlußmöglichkeit	offene Kabel
Ausgangsstrom	350 mA		

Produkteigenschaften

 Schutzklasse II	 Überspannungsschutz
SELV Schutzkleinspannung	 Lampenbetriebsgerät 110
 Kurzschlußfest	 Möbeleinbau geeignet
 Überlastschutz	ErP Standby-Stromverbrauch < 0,5 W
 Übertemperaturschutz	LVD Sicherheit nach EN 61347
 Sicherheitstrafo	EMC Funkentstörung + Störfestigkeit nach EN 55015 + EN 61547
 nicht dimmbar	EMC Netzstromoberwellen + Flicker nach EN 61000-3-2 + EN 61000-3-3

Schwarze Felder sind zutreffend / graue Felder sind nicht zutreffend

Artikel Nr.: 930594

Netzgerät, FLAT, CC, UT350mA/12W

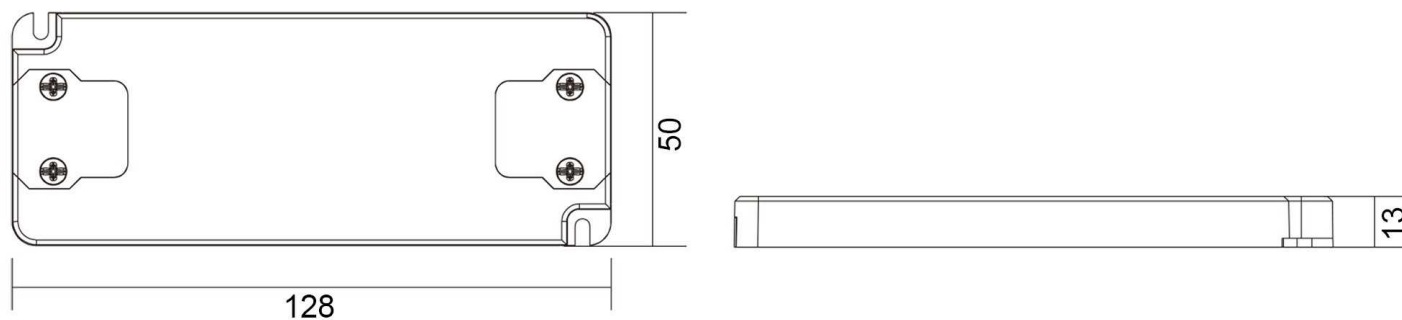
**Abmessungen und Gewicht****Grenzwerte**

Länge	128,00 mm	Betriebstemperatur	-20°C - +50°C
Breite	50,00 mm	Gehäusetemperatur	80,00
Höhe	13,00 mm		
Durchmesser	0,00 mm		
Gewicht	70 g		

Article No.: 930594

Power supply unit, FLAT, CC, UT350mA/12W











IP20 

Electrical Characteristics

Operating mode	constant current	Input voltage	220-240V AC/50-60Hz
Power	0,70-12,00 W	Power factor	0,50C
Output voltage	2-35V DC	Connection possibility	wire with open ends
Output current	350 mA		

Product features

	Protection class II		Overvoltage protection
SELV	Low voltage protection		Lamp control gear 110
	Short circuit protection		Suitable for furniture installation
	Overload protection	ErP	Standby-power consumption < 0,5 W
	Overheating protection	LVD	Safety according to EN 61347
	Safety transformer	EMC	Interference suppression + immunity according to EN 55015 + EN 61547
	not dimmable	EMC	Mains harmonics + flicker according to EN 61000-3-2 + EN 61000-3-3

Black fields are applicable / gray fields are not applicable

Article No.: 930594

Power supply unit, FLAT, CC, UT350mA/12W

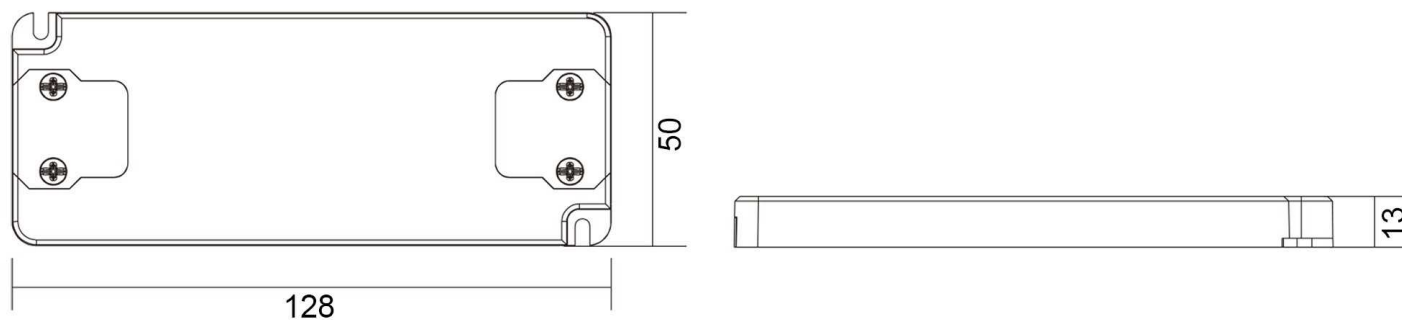
**Dimensions & Weight****Absolute maximum ratings**

Length	128,00 mm	Operating temperature	-20°C - +50°C
Width	50,00 mm	Case temperature	80,00
Height	13,00 mm		
Diameter	0,00 mm		
Product weight	70 g		