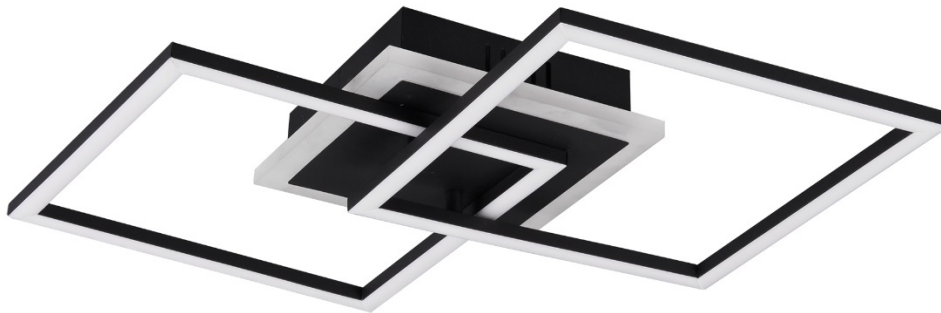

8032345

27W LED
incl. LED Board: L9002467
230V ~ 50Hz

(DE) Bestimmungsgemäße Verwendung

(GB) Intended use / (FR) Utilisation conforme / (NL) Beoogd gebruik / (PL) Stosowanie zgodnie z przeznaczeniem /
(NO) Riktig bruk / (DK) Korrekt brug / (SE) Avsedd användning / (FI) Määräystenmukainen käyttö
(IT) Impiego appropriato / (ES) Uso prescrito / (CZ) Použití v souladu s určením / (PT) Utilização correta / (GR) Ενδεικτική χρήση

(DE) Ortsfeste Verwendung als Deckenleuchte im Innenbereich	(GB) Provided for stationary indoor use on ceilings
(FR) Installation fixe en tant que plafonnier à l'intérieur	(NL) Vast gebruik als plafondlamp binnenshuis
(PL) Do montażu stacjonarnego jako lampa sufitowa do wnętrz	(NO) Til stasjonært bruk som taklampe innendørs
(DK) Til stationær brug som loftlampe indendørs	(SE) Används som fast taklampe inomhus
(FI) Kiinteä käyttö sisätilojen kattovalaisimena	(IT) Impiego fisso come plafoniera in ambienti interni
(ES) Empleo fijo como lámpara de techo en interiores	(CZ) Stacionární použití jako stropní svítidlo v interiéru
(PT) Aplicação fixa como luminária de teto em interiores	(GR) Σταθερή χρήση ως φωτιστικό οροφής σε εσωτερικό χώρο

(DE) Verwendete Symbole

(GB) Safety Precautions / (FR) Symboles utilisés / (NL) Gebruikte symbolen / (PL) Stosowane symbole / (NO) Brukte symboler /
(DK) Brugte symboler / (SE) Använda symboler / (FI) Käytetyt symbolit / (IT) Simboli usati / (ES) Símbolos empleados /
(CZ) Použité symboly / (PT) Símbolos utilizados / (GR) Χρησιμοποιούμενα σύμβολα

IP 20

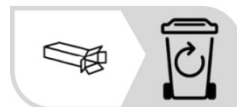
(DE) Lieferumfang

(GB) Package contents / (FR) Contenu de la livraison / (NL) Bij de levering inbegrepen / (PL) Zakres dostawy / (NO) Leveringsomfang / (DK) Leveringsomfang / (SE) Leveransomfattning / (FI) Toimitussisältö / (IT) Fornitura / (ES) Volumen de suministro / (CZ) Rozsah dodávky / (PT) Material fornecido / (GR) Παραδοτέος εξοπλισμός

(DE) 1 Deckenleuchte Montagematerial Montageanleitung	(GB) 1 Ceiling lamp Installation hardware Mounting instructions	(FR) 1 Plafonnier Matériel de montage Instructions de montage
(NL) 1 Plafondlamp Monteringsmateriale Montagehandleiding	(PL) 1 Lampa sufitowa Elementy montażowe Instrukcja montażu	(NO) 1 Taklampe Monteringsmateriale Brukerveiledning
(DK) 1 Loftlampe Monteringsmateriale Brugervejledning	(SE) 1 Taklampe Monteringsmaterial Monteringsanvisning	(FI) 1 Kattovalaisin Asennus materiaali Asennusohjeet
(IT) 1 Plafoniera Materiale di montaggio Istruzioni di montaggio	(ES) 1 Lámpara de techo Material de montaje Instrucciones de montaje	(CZ) 1 Stropní svítidlo Materiál pro montáž Návod k montáži
(PT) 1 Luminária de teto Material de montagem Instruções de montagem	(GR) 1 Φωτιστικό οροφής Υλικό συναρμολόγησης Οδηγίες συναρμολόγησης	

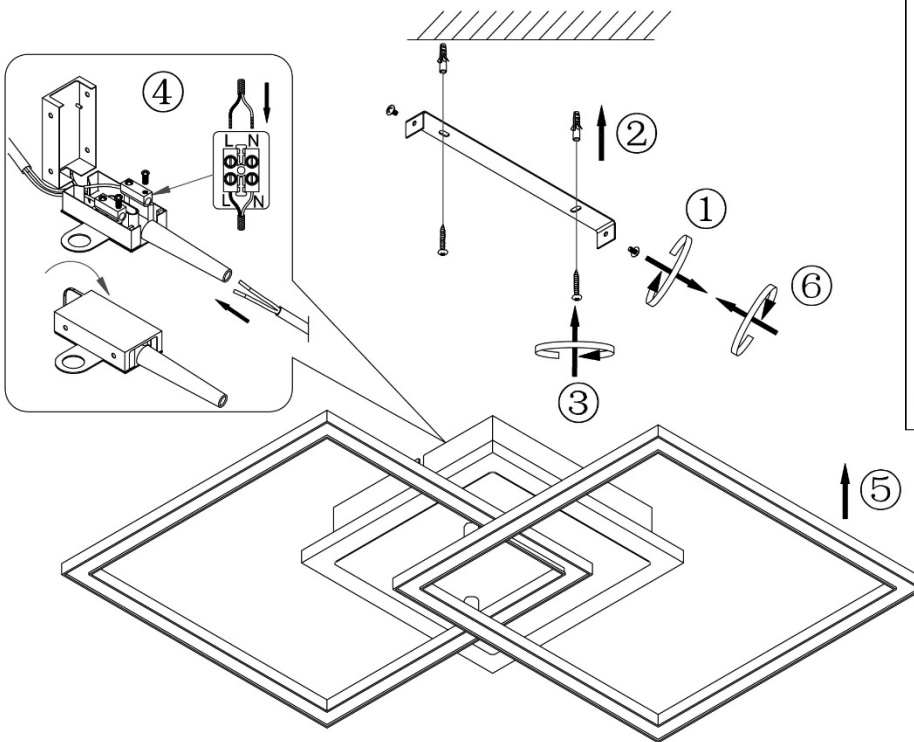
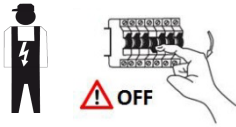

Variation der Lichtfarbe mit dem Wandschalter
Variation of the color temperature with the wall switch
Variation de la température de couleur avec l'interrupteur mural

ON	OFF/ON	OFF/ON	OFF/ON
100%	100%	100%	warm night
3000K	4000K	6500K	light

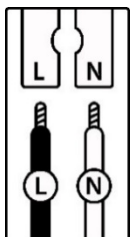
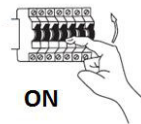

	(DE)	(GB)	(FR)	(NL)	(PL)	(NO)	(DK)
L	Stromführender Leiter	Live conductor	Conducteur	Spanningvoerende draad	Przewód prądowy	Strømførende leder	Strømførende leder
N	Neutralleiter	Neutral conductor	Conducteur neutre	Nulleider	Przewód zerowy	Nøytralleider	Neutralleider

	(SE)	(FI)	(IT)	(ES)	(CZ)	(PT)	(GR)
L	Strömförande ledare	Virtajohdin	Conduttore sotto tensione	Líneas conductoras de corriente	Vodič pod napětím	Condutor vivo	Ρευματοφόρος αγωγός
N	Neutralledare	Nollajohdin	Conduttore neutro	Conductor neutro	Neutrální vodič	Condutor neutro	Ουδέτερος αγωγός

Fernbedienung/ remote control/ télécommande

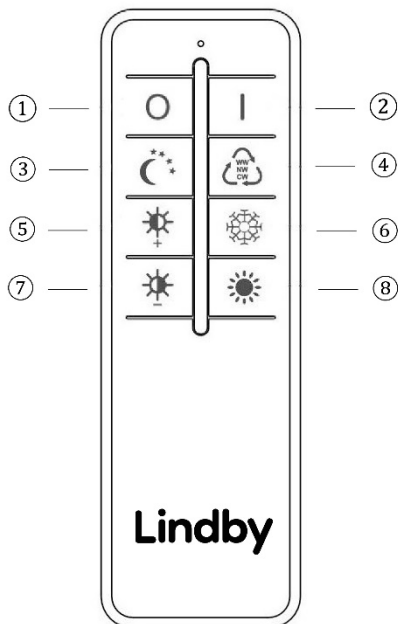

Funktionsbeschreibung mit Fernbedienung

Es wird immer das zuletzt eingestellte Lichtszenario wiedergegeben (Memory-Effekt).

Das synchrone Steuern von mehreren Leuchten ist nicht vorgesehen.

Bedienung der Fernbedienung

1. & 2. Ein/Aus

3. Nachtlicht

4. Modus:

1. Schritt: 2700K/ 2. Schritt: 4000K/ 3. Schritt: 6000K

5. & 7. Helligkeitsregler: Die Regulierung erfolgt stufenweise. Durch kurzes Drücken lassen sich die einzelnen Stufen ansteuern. Durch dauerhaftes Drücken der Taste wird das Maximum bzw. Minimum an Helligkeit erreicht.

6. & 8. Die Regulierung erfolgt stufenweise. Durch kurzes Drücken lassen sich die einzelnen Stufen ansteuern. Durch dauerhaftes Drücken der Taste wird die wärmste bzw. kälteste Farbeinstellung erreicht.

Fernbedienung einrichten

Taste 2 gedrückt halten und Leuchte über Wandschalter einschalten. Nach 5 Sekunden blinkt die Lampe einmal, bedeutet erfolgreiche Kodierung

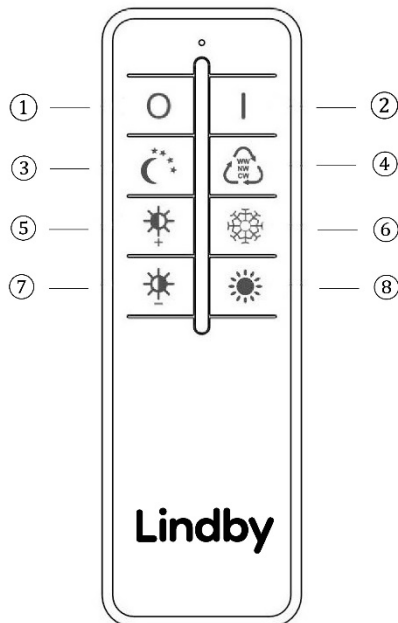

Description of how the light works with the remote control unit

The most recently configured light setting is always displayed (memory effect)

The synchronous control of several lights is not foreseen.

Operation of the remote control

1. & 2. On/Off

3. Night light

4. Mode:

1. Step: 2700K/ 2. Step: 4000K/ 3. Step: 6000K

5. & 7. Brightness regulator: The adjustment takes place in stages. By pressing for a short period, it is possible to control the individual stages. Pressing the button permanently results in the maximum or minimum brightness being reached.

6. & 8. The adjustment takes place in stages. By pressing for a short period, it is possible to control the individual stages. Pressing the button permanently results in the warmest or coldest colour setting being reached.

Set up remote control

Press and hold key 2 and switch on light using wall switch. After 5 seconds the light will flash once, signalling successful coding

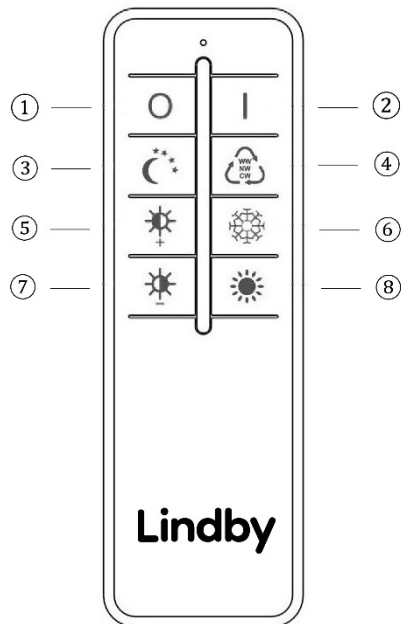

Description des fonctions avec la telecommande

L'effet de lumière réglé en dernier est toujours restitué (effet mémoire).

Il n'est pas prévu de pouvoir commander plusieurs lampes en même temps.

Utilisation de la telecommande

1. & 2. On/Off

3. Veilleuse

4. Mode:

1. Étape: 2700K/ 2. Étape: 4000K/ 3. Étape: 6000K

5. & 7. Regulateur de luminosité : Ce réglage se fait par paliers. Les différents degrés se règlent par une légère pression sur la touche. En appuyant en continu sur la touche, on atteint la luminosité maximale ou minimale.

6. & 8. Ce réglage se fait par paliers. Les différents degrés se règlent par une légère pression sur la touche. En appuyant en continu sur la touche, on atteint le réglage le plus chaud ou le plus froid de la couleur.

Régler la télécommande

Appuyez et maintenez enfoncée la touche 2, puis allumez la lumière à l'aide de l'interrupteur mural. Au bout de 5 secondes, le voyant clignote une fois pour indiquer que le codage a réussi

	QR	EAN
<p>(DE) Dieses Produkt enthält eine Lichtquelle der Energieeffizienzklasse E (EN) This product contains a light source of energy efficiency class E (FR) Ce produit comprend une source de lumière de classe d'efficacité énergétique E (NL) Dit product bevat een lichtbron van energie-efficiëntieklasse E (PL) Produkt ten zawiera źródło światła o klasie efektywności energetycznej E (NO) Dette produktet inneholder en lyskilde i energieeffektivitetsklasse E (DK) Dette produkt indeholder en lyskilde af energieeffektklasse E (SE) Denna produkt innehåller en ljuskälla i energieffektivitetsklass E (FI) Tämä tuote sisältää energiätehokkuusluokan E valonlähteen (IT) Questo prodotto contiene una sorgente luminosa della classe di efficienza energetica E (ES) Este producto contiene una fuente de luz de la clase de eficiencia energética E (CZ) Tento výrobek obsahuje světelný zdroj třídy energetické účinnosti E (PT) Este produto contém uma fonte de luz da classe de eficiência energética E (GR) Αυτό το προϊόν περιέχει μια φωτεινή πηγή ενεργειακής απόδοσης κλάσης E (SK) Tento výrobok obsahuje zdroj svetla triedy energetickej efektivity E</p>		<p>4251911754537</p>

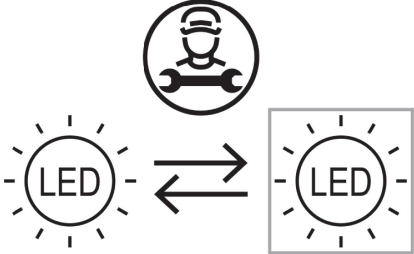
	<p>(DE) Durch einen Fachmann austauschbare Lichtquelle (nur LED). (EN) Replaceable (LED only) light source by a professional. (FR) Source de lumière remplaçable (LED uniquement) par un professionnel. (NL) Lichtbron (alleen led) te vervangen door een professional. (PL) Wymienne (tylko LED) źródło światła wykonane przez profesjonalistę. (NO) Utskiftbar (kun LED) lyskilde av en profesjonell. (DK) Udskiftelig lyskilde (kun LED), udskiftes af en elektriker. (SE) Ljuskälla (endast LED) utbytbar genom fackman. (FI) Ammattilainen voi vaihtaa vaihdettavan (vain LED) valonlähteen. (IT) Sorgente luminosa (solo LED) sostituibile da un professionista. (ES) Fuente de luz (solo LED) sustituible por un profesional. (CZ) Vyměnitelný (pouze LED) světelný zdroj odborníkem. (PT) Luz LED (apenas LED) substituível por um profissional. (GR) Η πηγή φωτός (μόνο LED) να αντικαθίσταται από επαγγελματία. (SK) Zdroj svetla (iba LED) vymeniteľný prostredníctvom odborníka.</p>
--	--

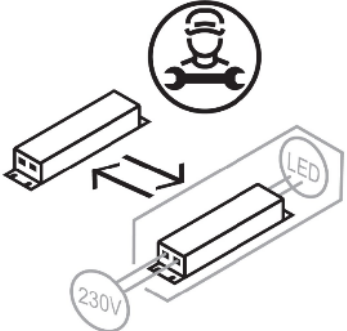
	<p>(DE) Durch einen Fachmann austauschbares Betriebsgerät. (EN) Replaceable control gear by a professional. (FR) Contrôleur remplaçable par un professionnel. (NL) Voorschakelapparatuur te vervangen door een professional. (PL) Wymienny układ sterujący przez profesjonalistę. (NO) Utskiftbar kontrollutstyr av en profesjonell. (DK) Udskiftelig igangsætter, udskiftes af en elektriker. (SE) Styrdon utbytbar genom fackman. (FI) Ammattilainen voi vaihtaa vaihdettavat ohjauslaitteet. (IT) Dispositivo di controllo sostituibile da un professionista. (ES) Dispositivo de control sustituible por un profesional. (CZ) Vyměnitelný předřadník odborníkem. (PT) Dispositivo de controlo substituível por um profissional. (GR) Ο εξοπλισμός ελέγχου να αντικαθίσταται από επαγγελματία. (SK) Predradník vymeniteľný prostredníctvom odborníka.</p>
---	--