



Paulmann



IP67



Info

www.paulmann.com

Paulmann Licht GmbH  
Quezinger Feld 2  
31832 Springe  
Germany



www.paulmann.com

Nº: 949.11, 949.13



2023/1542 EU, Nº 41:  
battery@paulmann.de

PIB 02/25



Li-Ion



230 000 043

xx/yyyy

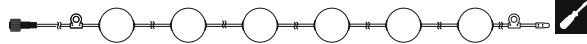

949.10:



X1



X1



Incl.

949.13:

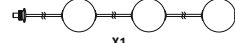

X1

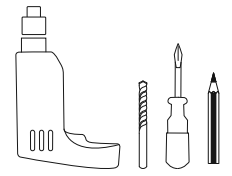

A1 A2 A3

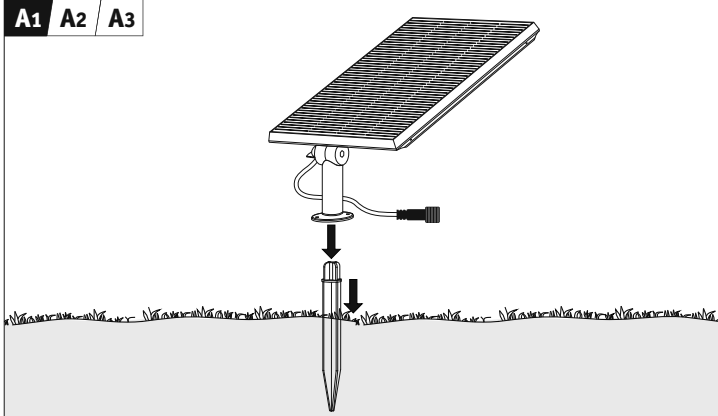

A1 A2 A3

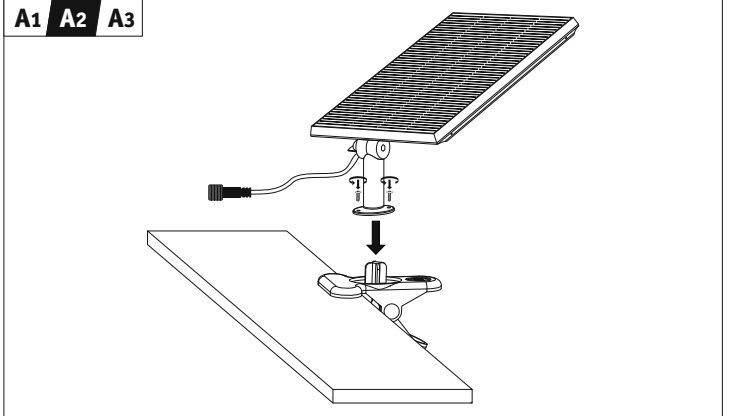

A1 A2 A3

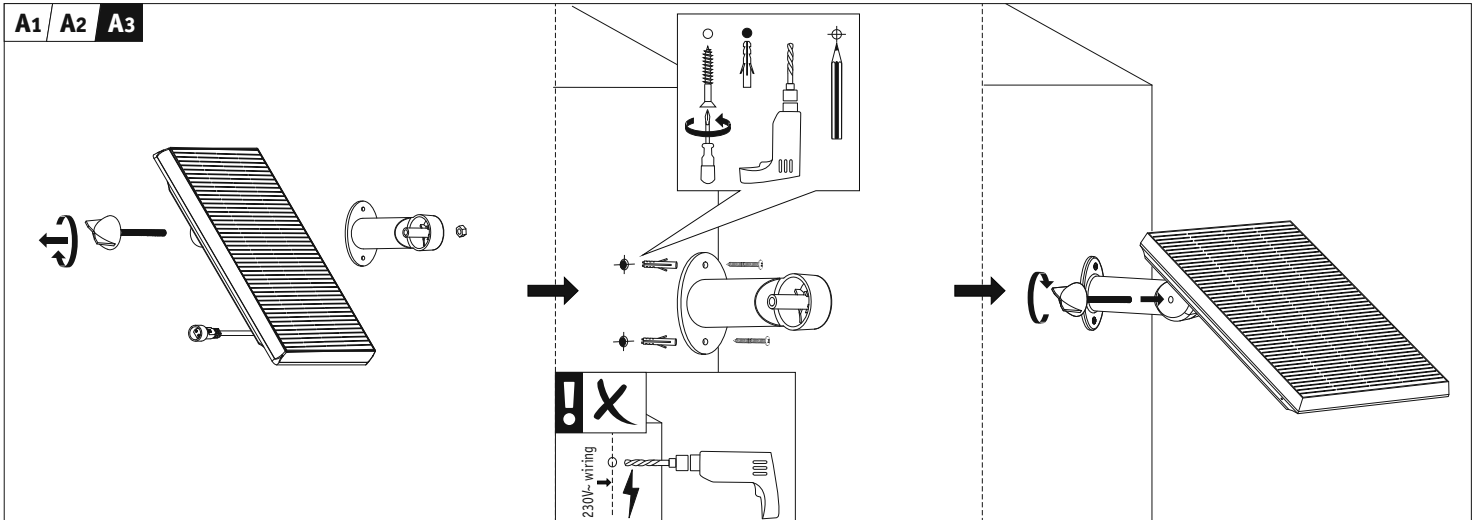

B

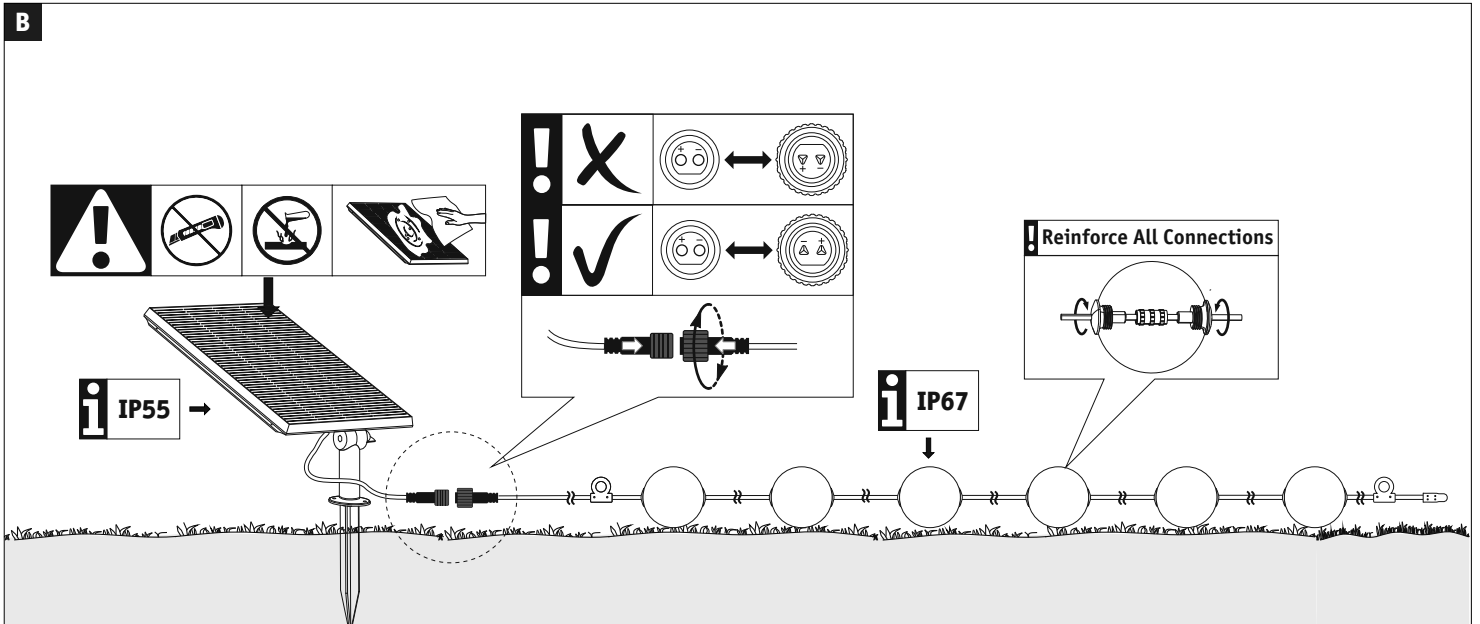

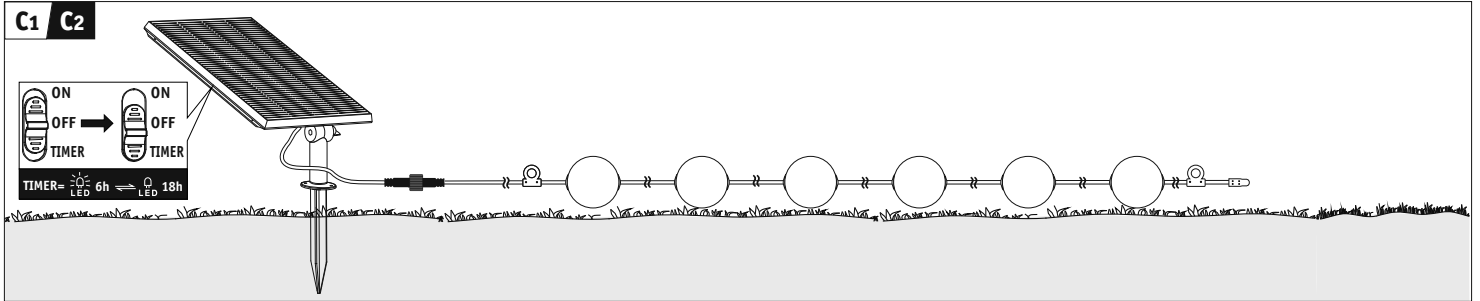
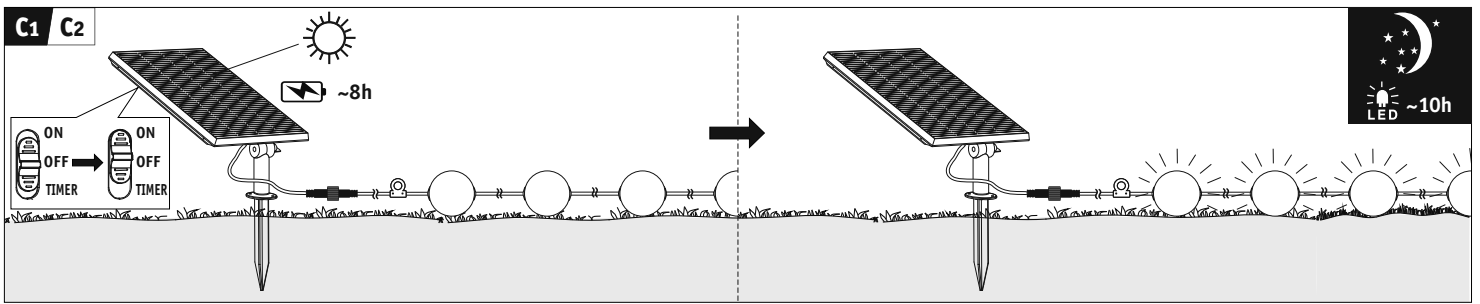

**! extension**

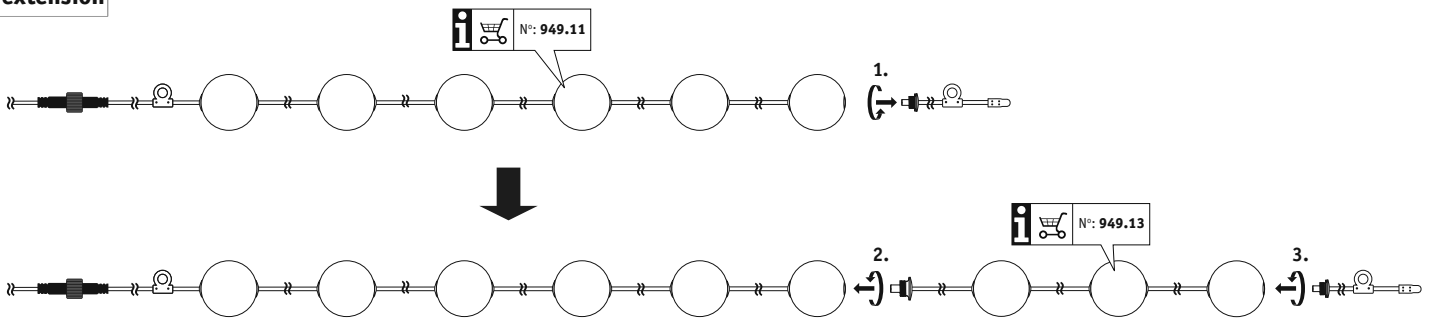

**! How to replace the bulb**

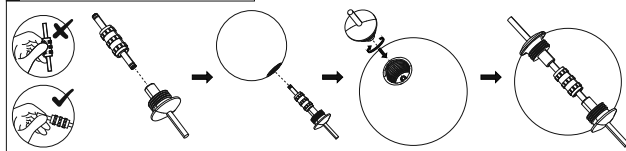

**!** DE Nur wiederaufladbare Batterien verwenden  
 EN Only use rechargeable  
 FR N'utiliser que des piles rechargeables  
 2x Li-Ion Battery (3,6V 2500mAh)

= DE Altgeräte dürfen nicht in den Restmüll. Sie können bei öffentlichen Sammelstellen von Entsorgungsträgern abgegeben werden. Altbatterien und Altakkumulatoren, sowie Lampen, die zerstörungsfrei aus dem Altgerät entnommen werden können, sind vor der Abgabe an eine Erfassungsstelle von dem Altgerät zu trennen. Vertreiber sind im Rahmen von § 17 Absatz 1 und 2 ElektroG zur unentgeltlichen Rücknahme dieses Produktes verpflichtet. Endnutzer von Altgeräten müssen eigenverantwortlich für die Löschung personenbezogener Daten auf den zu entsorgenden Altgeräten sorgen.  
[www.paulmann.com](http://www.paulmann.com)

= FR Les piles et accumulateurs usagés, ainsi que les lampes qui peuvent être retirées de l'appareil usagé sans être détruites, doivent être séparés de l'appareil usagé avant d'être remis à un point de collecte. Les distributeurs sont tenus de reprendre gratuitement ce produit dans le cadre de l'article 17, paragraphes 1 et 2 de l'ÉlektroG. Les utilisateurs finaux d'équipements usagés doivent veiller, sous leur propre responsabilité, à la suppression des données à caractère personnel sur les équipements usagés à mettre au rebut.  
[www.paulmann.com](http://www.paulmann.com)

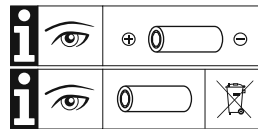

rechargeable battery  
 18650 3.6V 2500mAh

