

) david
trubridge

Project



Coral



Coral Pendant is based on one of the geometric polyhedra that have interested David since he was a boy. The intricate form is made from just one single component repeated 60 times. Originally designed purely as an experiment, it only became a light later when David tried to find a use for it by putting a bulb inside.

The plywood finish can be all natural or painted creating a wide range of colour options. Coral was David's first lighting design which now is considered to be a design classic.



Features

Shipped Kitset

Seed System kitset lightshades are on average 1/30th of the volume of the assembled light. This aims to help minimize the effects of shipping and to reduce the design's environmental footprint.

Compliance

CE

AS/NZS

(Declarations of conformity available on request).

Care Instructions

All wooden and/or polycarbonate lights are intended for use in dry interior conditions only and can be cleaned with a soft cloth dampened slightly in warm soapy water when the light is switched off. Do not use detergents.

Light sizes

David Trubridge kitset lightshades come in various sizes, making it easy to find the right size to any interior space whether it's small or large.

EPD Certified

An EPD is a standardised and verified way of quantifying the environmental impacts of a product, based on a consistent set of rules that have been developed through a stakeholder consultation process.

Warranty

This light is warranted for three years from date of purchase for failure of parts.



THE INTERNATIONAL EPD® SYSTEM

Technical Data

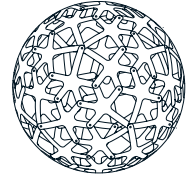
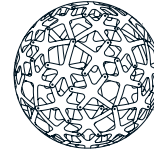
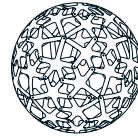
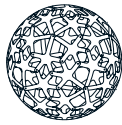
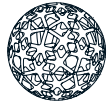

400mm/16"

600mm/24"

800mm/31"

1000mm/39"

1200mm/47"

1600mm/63"

Diameter: 400mm / 16"	Diameter: 600mm / 24"	Diameter: 800mm / 31"	Diameter: 1000mm / 39"	Diameter: 1200mm / 47"	Diameter: 1600mm / 63"
Weight: 0.4kg / 0.88lb	Weight: 1kg / 2.20lb	Weight: 1.5kg / 3.30lb	Weight: 2.3kg / 5.07lb	Weight: 3.8kg / 8.37lb	Weight: 9kg / 19.84lb
2m / 6.5ft	2m / 6.5ft	2m / 6.5ft	3m / 9.8ft	5m / 16.4ft	5m / 16.4ft
Bamboo plywood (Sourced from FSC accredited factory)	Bamboo plywood (Sourced from FSC accredited factory)	Bamboo plywood (Sourced from FSC accredited factory)	Bamboo plywood (Sourced from FSC accredited factory)	Bamboo plywood (Sourced from FSC accredited factory)	Bamboo plywood (Sourced from FSC accredited factory)
Nylon	Nylon	Nylon	Nylon	Nylon	Aluminium
Hangs on cord	Hangs on cord	Hangs on cord	1 x Suspension Wire	1 x Suspension Wire	1 x Suspension Wire
290mm x 170mm x 85mm 11" x 7" x 3" 0.004m ³ / 0.141ft ³ 0.7kg / 1.54lb	385mm x 215mm x 105mm 15" x 8" x 4" 0.009m ³ / 0.317ft ³ 1.4kg / 3.00lb	500mm x 280mm x 100mm 20" x 11" x 4" 0.014m ³ / 0.494ft ³ 2.3kg / 5.1lb	400mm x 310mm x 125mm 16" x 12" x 5" 0.016m ³ / 0.565ft ³ 3.2kg / 7.1lb	365mm x 425mm x 125mm 14" x 17" x 5" 0.019m ³ / 0.671ft ³ 4.2kg / 9.25lb	470mm x 395mm x 180mm 19" x 16" x 7" 0.33m ³ / 1.165ft ³ 9.5kg / 20.94lb

Dimensions

Cordset*

Material

Fasteners

Suspension

Packaging

*Black comes with black cordset and fasteners. All others come with white cordset and clear fasteners. Custom lengths available on request.

You will need:

Fixings for cone gripper (fixing screws NOT SUPPLIED).

Note: Choose appropriate hardware to attach base plate (Fig.1) to ceiling substrate.

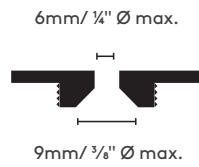

Fig 1. Base Plate

Installation

1000mm/39"

1200mm/47"

1600mm/63"

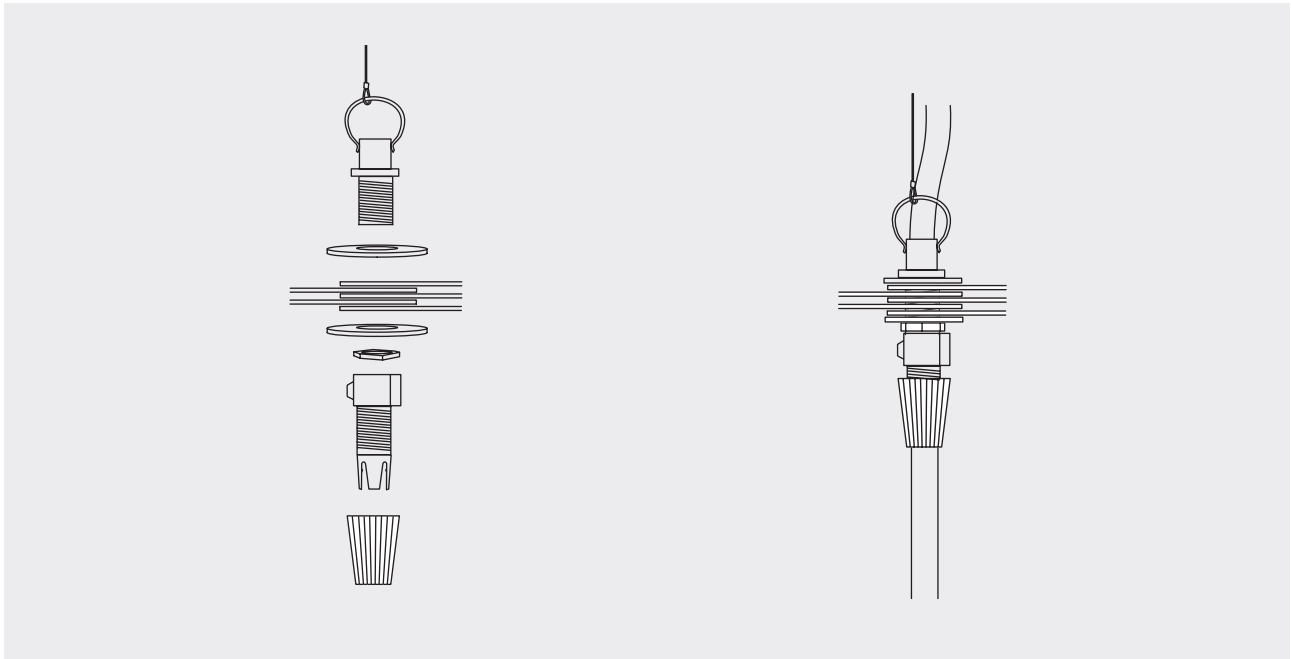

Step 1.

Follow the order of each component in diagram. Adjust the bulb / lamp to mid way in the pendant lightshade shown in Step 2 and then tighten.

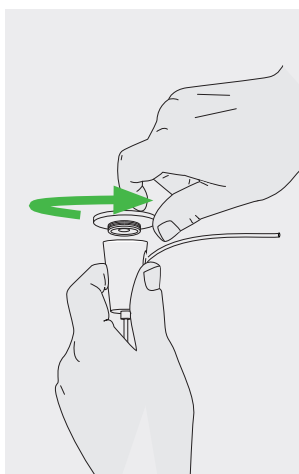

Step 2.
Unscrew baseplate.

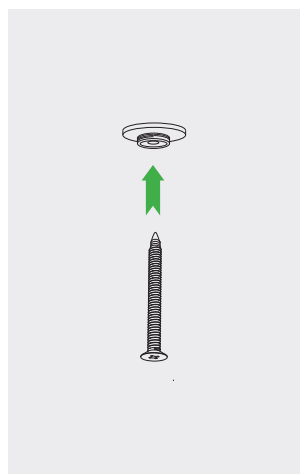

Step 3.
Use appropriate fixing screw to mount base plate (Fig.1).

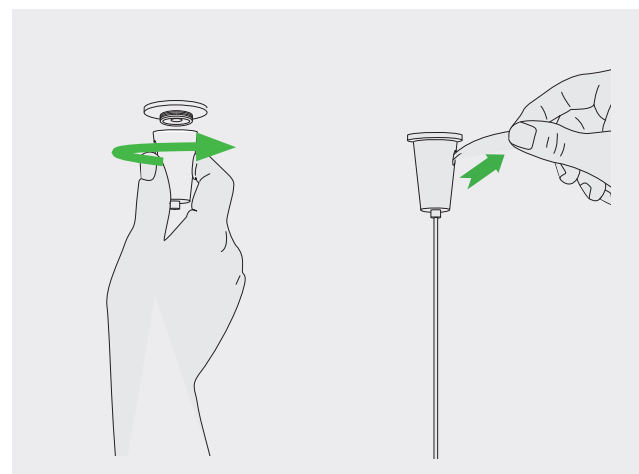

Step 4.
Remove cable from cone. Screw cone back onto baseplate. Re-insert cable and level light. Once desired position is set, trim excess cable.

Diagrams

400mm/16"

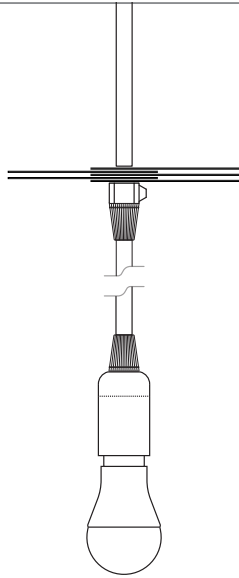

North America: E26, Max 60 Watts
120v AC 60hz
Rest of World: E14, Max 60 Watts
230-240v AC 50hz

600mm/24"
800mm/31"

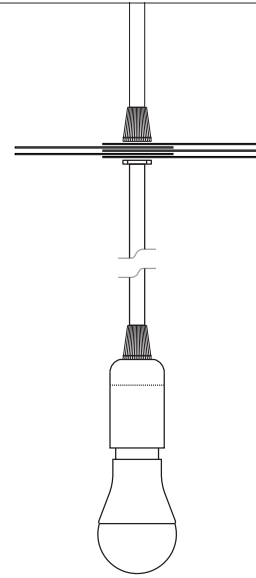

North America: E26, Max 60 Watts
120v AC 60hz
Rest of World: E27, Max 60 Watts
230-240v AC 50hz

1000mm/39"
1200mm/47"
1600mm/63"

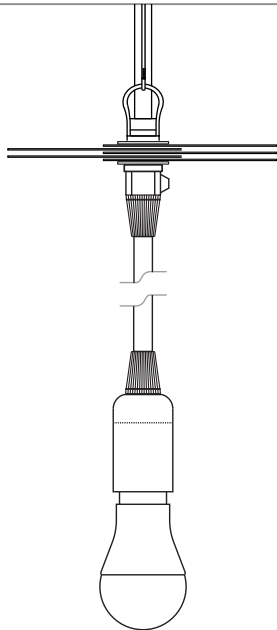

North America: E26, Max 60 Watts
120v AC 60hz
Rest of World: E27, Max 60 Watts
230-240v AC 50hz

david trubridge Pendant Series

This luminaire is compatible with bulbs of the energy classes:

A+++
A++
A+
A
B
C
D
E

874/2012

Finish Choices

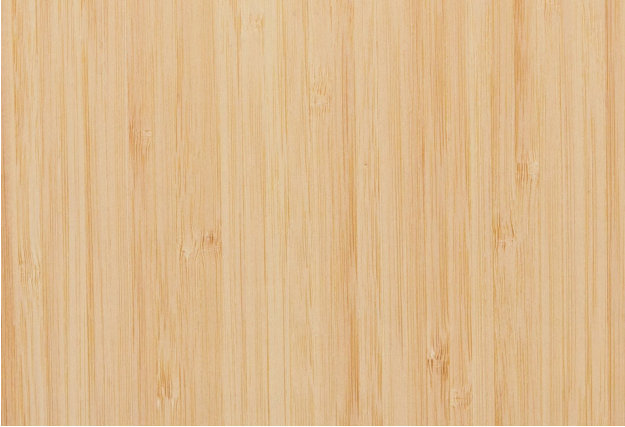

Natural

All bamboo (our primary material) is secondary product, from renewable forests in China grown as a food source. We have visited these plantations and are satisfied with the quality of their systems.



Caramel

Caramel bamboo starts out as natural and is carbonised using steam to caramelise the natural sugars which darken the bamboo. This process creates a different look without using chemicals.



Painted Lights

We use an acrylic low VOC (volatile organic compound) paint that is made in New Zealand. Colour swatches are available in all retailers. See the Resene website for more info. www.resene.co.nz



Natural



Caramel

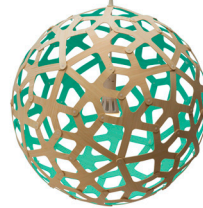

Aqua



Lime



Red

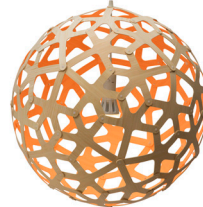

Orange

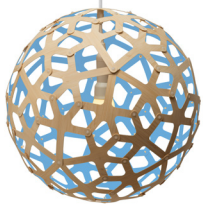

Blue



Pink

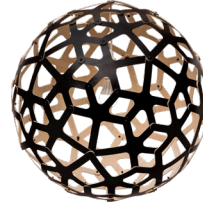

Black 1 Side (Outside)



Black 1 Side (Inside)



Black 2 Sides



White 1 Side



White 2 Sides



Contact

New Zealand
Showroom/Head office

Contact

+64 6 6500 204
info@davidtrubridge.com

Address

Corner Station Road &
Groome Place, Whakatu,
Hastings, Hawkes Bay,
New Zealand