

Instructions

Utzon JU1

Jørn Utzon

1947



Congratulations with your new Utzon lamp, designed in 1947 by Jørn Utzon. We hope you will enjoy using this product and follow these instructions to ensure correct installation. If you have any questions or comments, please do not hesitate to contact us by mail at:
info@andtradition.com

&Tradition®

Utzon JU1

Jørn Utzon

1947

Please read these instructions carefully and retain them for future reference to ensure that the product is used correctly. For your own safety, please study each step of this instruction manual first. &Tradition is not responsible for any faults or damages caused by not following these instructions correctly. Do not modify this product in any way.

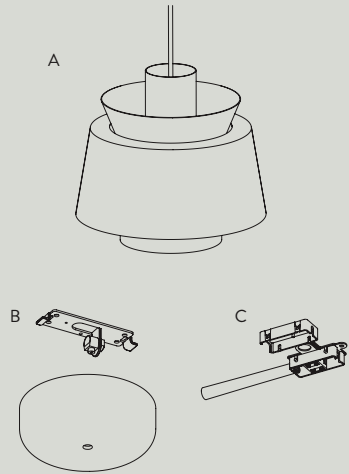

Contents

- A Utzon lamp
- B Canopy and ceiling bracket
- C Connection box

Tools needed

- Bulb type E27
- Small flat-head screwdriver for wiring

Safety precautions

- Dispose of plastic bag from packaging and do not allow children to play with it.
- Keep product well out of children's reach.
- The lamp is only intended for interior use.
- Consult a professional qualified electrician if in any doubt.
- Do not place the cable within reach of small children or anywhere with a risk of falling over it.

Cleaning instructions

- Wipe surface of lamp shade with a soft, damp sponge or cloth.
- Do not use any abrasive cleaning tools such as steel wool, scouring sponges or stiff brushes.
- Never use strong cleaning agents such as white spirit, turpentine, household glass cleaner or cellulose thinners.
- Only wipe the inside of the shade with a soft, damp cloth or feather duster.

For indoor use only
E27 maximum 60W
Bulb not included

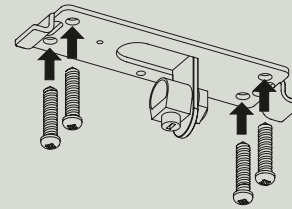

Step 1

Ensure power supply is turned off and remove any existing lamp fitting. Locate the supply cable and ensure it is ready to be fitted to the connector box.

Mount the metal bracket (B) securely in the ceiling with screws and wall plugs, appropriate for the ceiling of installation.

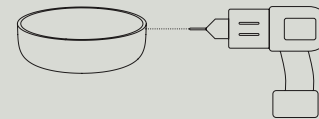

Step 2

Drill a hole into the side of the canopy and pull electric cord through it

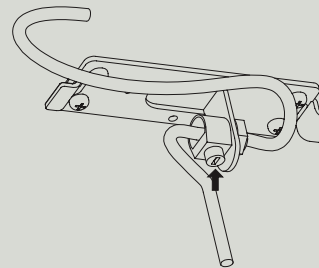

Step 3

To determine the right suspension height for the lamp, pass the electrical cord through the strain relief of the metal bracket (C). When you have the desired suspension height of the lamp, tighten the plastic screw of the strain relief.

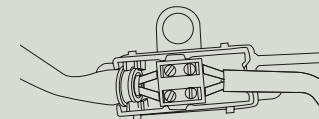

Step 4

Use the terminal box inside the connection box (D) to assemble the wires from the pendant with the wires from the power supply. Close the connection box and place it inside the canopy.



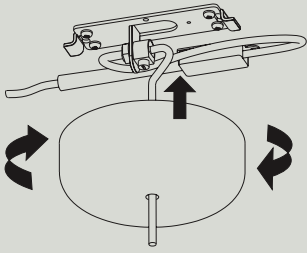

Step 5

Install the plastic canopy onto the metal bracket.

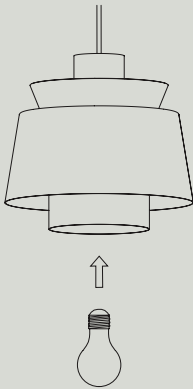

Step 6

Install the E27 light bulb.