

827  
**AMARCORD**

Design: Adolini + Simonini associati - 2017

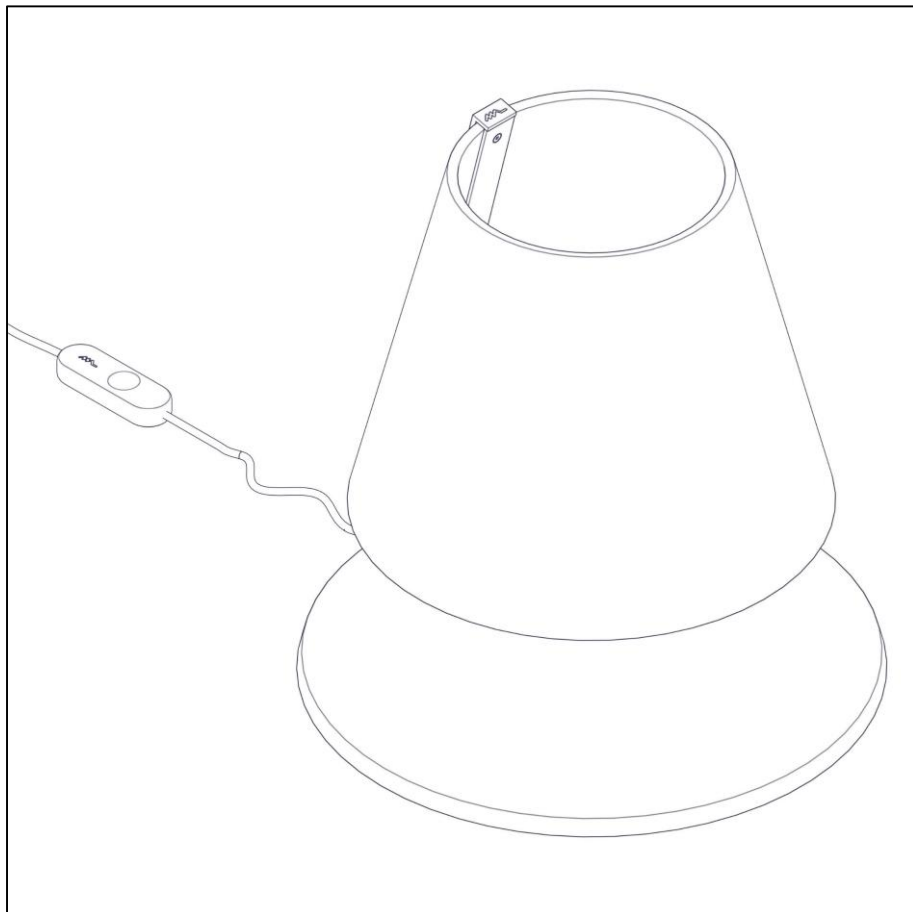

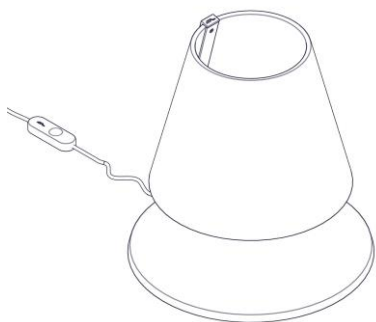
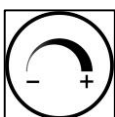
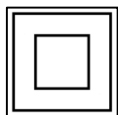
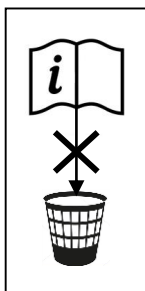
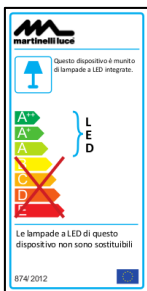
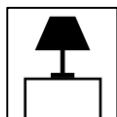

x 1

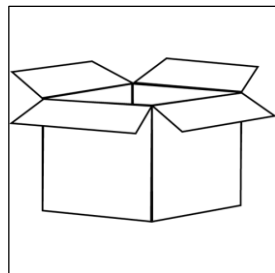

x 1

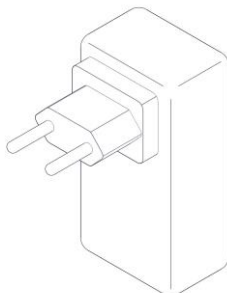

x 1

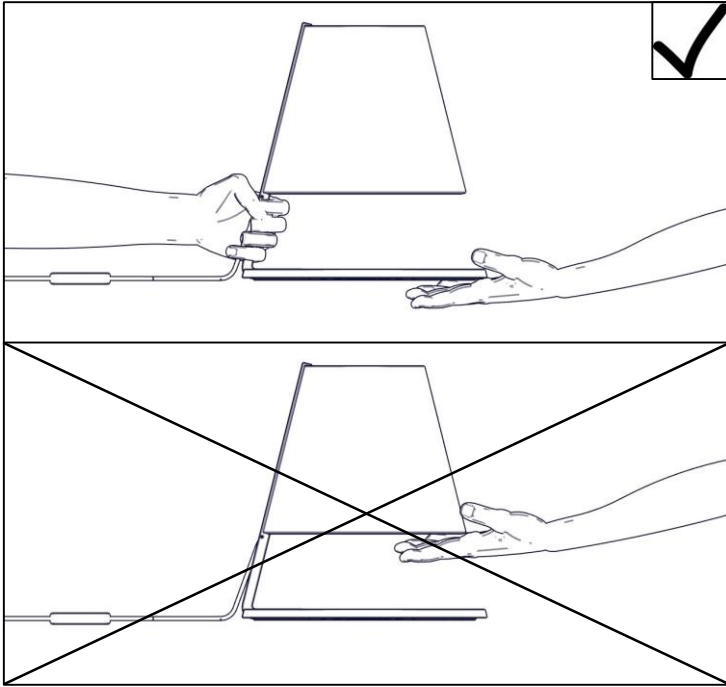

1

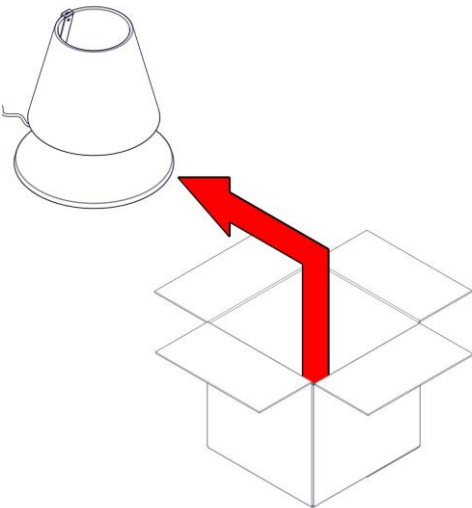

2



3

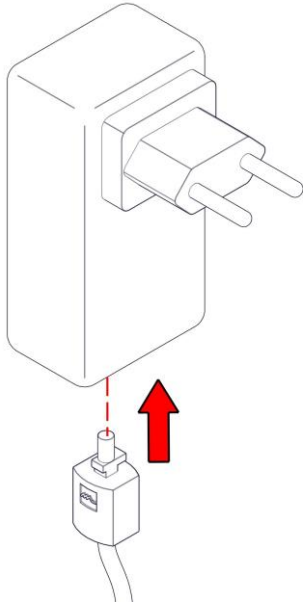

4

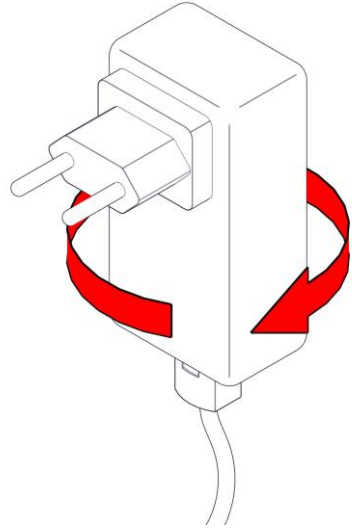

5

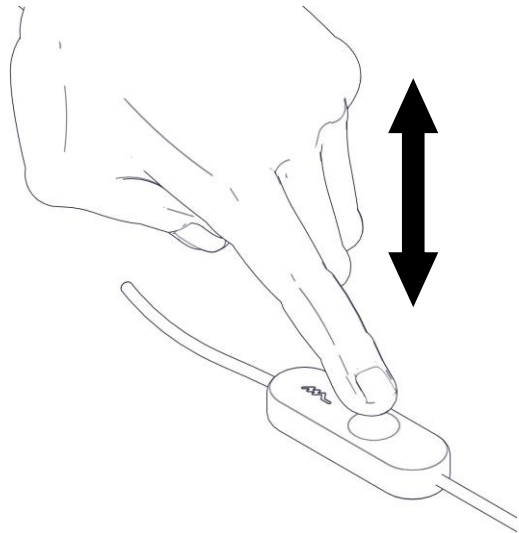
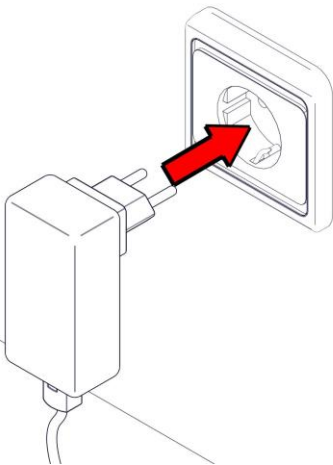

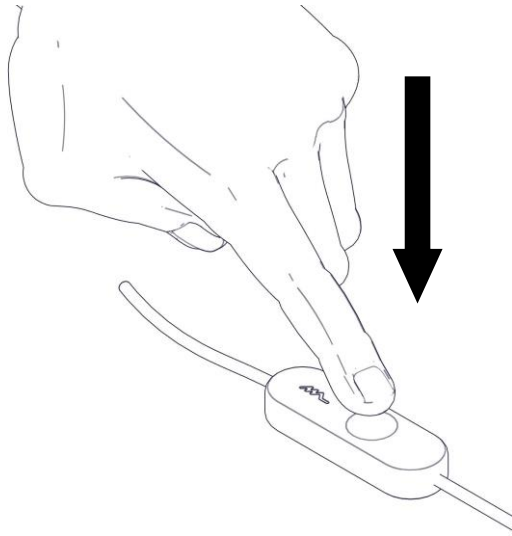

*i*

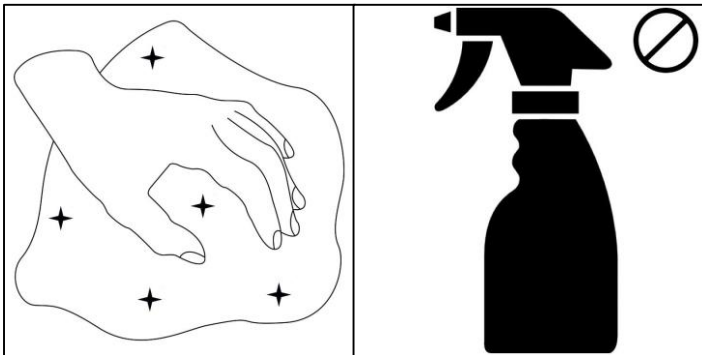





# **martinelli luce**

Via Teresa Bandettini  
55100 Lucca (Lu) – Italy

Tel.+39/0583.418315  
Fax. +39/0583.419003

[www.martinelliluce.it](http://www.martinelliluce.it)  
[info@martinelliluce.it](mailto:info@martinelliluce.it)