



# Ginger

## Joan Gaspar

marset



**Ginger 60**

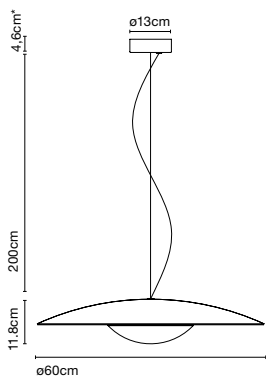

\* 6,5cm (DALI)

**Ginger 42**

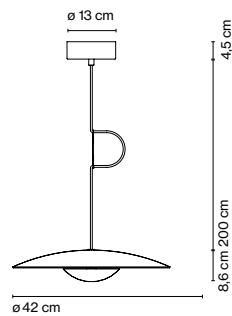

**Ginger 32**

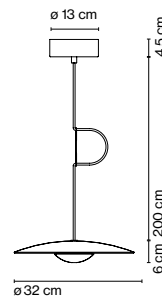

Wood is a great ally of cozy lighting. It is a material that is hard to mold, a challenge that the Ginger collection neatly resolves. The combination of sheets of wood and paper pressed together under high pressure achieves a laminate that appears almost entirely flat.

**Ginger 60**

Light source: LED SMD 700mA 22,4W 2700K CRI90 2933lm  
 Luminaire: 180 - 295 VAC TRIAC 26,09W 1165lm  
 220 - 240 VAC DALI 26,37W 1165lm  
 220 - 240 VAC 1-10V 27,15W 1165lm  
 LED included

**Ginger 42**

Light source: LED SMD 700mA 16,28W 2700K CRI90 1873lm  
 Luminaire: 180 - 295 VAC TRIAC 19,71W 698lm  
 220 - 240 VAC DALI 20,32W 698lm  
 220 - 240 VAC 1-10V 20,85W 698lm  
 LED included

**Ginger 32**

Light source: LED SMD 700mA 8,2W 2700K CRI90 913lm  
 Luminaire: 220 - 240 VAC TRIAC 10,87W 350lm  
 220 - 240 VAC DALI 11,59W 350lm  
 220 - 240 VAC 1-10V 10,36W 350lm  
 LED included

- Oak
- Wenge
- Brushed brass - Brushed brass
- Brushed brass - White
- Black - White

Black electrical cord

**Pressed wood or brushed aluminum diffuser. Injected and lacquered black metal matte aluminum dissipater.**

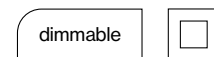

- [Download](#) Assembly Instructions
- [Download](#) Photometric Data
- [Download](#) 2D
- [Download](#) 3D
- [Download](#) Energy label

**Range**

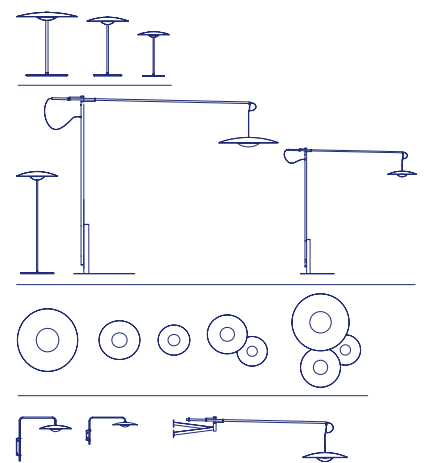



**Ginger 20**

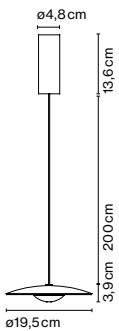

**Ginger 20x3**

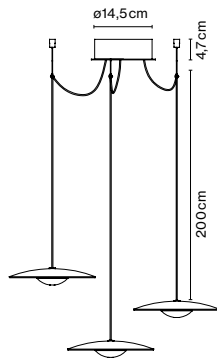

**Ginger 20x3:  
Canopy accessory**

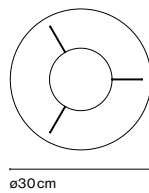

**Ginger 20**

Light source: LED SMD  
350mA 4,05W 2700K CRI90  
463lm  
Luminaire: 220 - 240 VAC  
TRIAC 5,72W 161lm  
LED included

**Ginger 20x3**

Light source: LED SMD  
350mA 4,1W(x3) 2700K  
CRI90 463lm(x3)  
Luminaire: 220 - 240 VAC  
TRIAC 15,13W 161lm(x3)  
LED included

- Oak - Oak
- Wenge - Wenge
- Oak - White
- Wenge - White
- Brushed brass - Brushed brass
- Brushed brass - White
- Black - White

Black electrical cord

**Watch the video**

info@marset.com  
www.marset.com

**Pressed wood or brushed aluminum diffuser. Injected and lacquered black metal matte aluminum dissipater.**

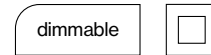

- [Download](#) Assembly Instructions
- [Download](#) Photometric Data
- [Download](#) 2D
- [Download](#) 3D
- [Download](#) Energy label

**Range**

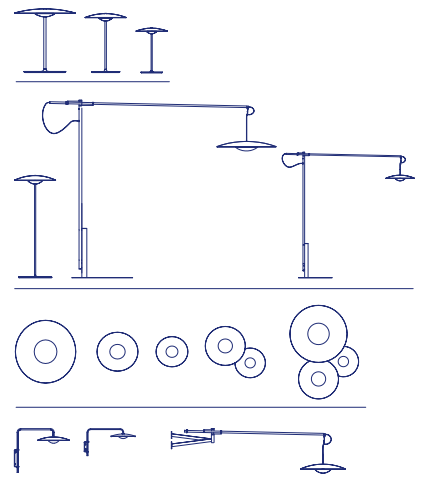

Wood is a great ally of cozy lighting. It is a material that is hard to mold, a challenge that the Ginger collection neatly resolves. The combination of sheets of wood and paper pressed together under high pressure achieves a laminate that appears almost entirely flat.

**For mounted canopy installation**

Take into account the total power in watts, the power of the driver, and the wire entry points of the canopy. The total wattage of the selected lamps elements cannot exceed the max wattage of the canopy's driver. Therefore, you must choose your canopy/driver by the power required. Finally, the number of lamps installed in a single canopy cannot exceed the number of wire entry points of that canopy.

**Canopy 20W/ Circular**

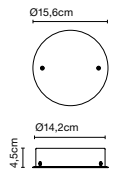

**Canopy 50W/ Circular**

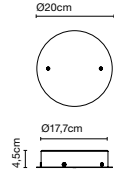

**Canopy 50W/ Rectangular**

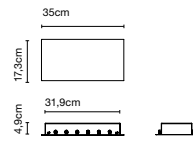

**Canopy 50W/ Circular**

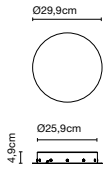

**Canopy 100W/ Circular**

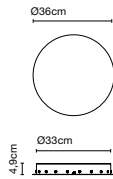

**Hook accessory**

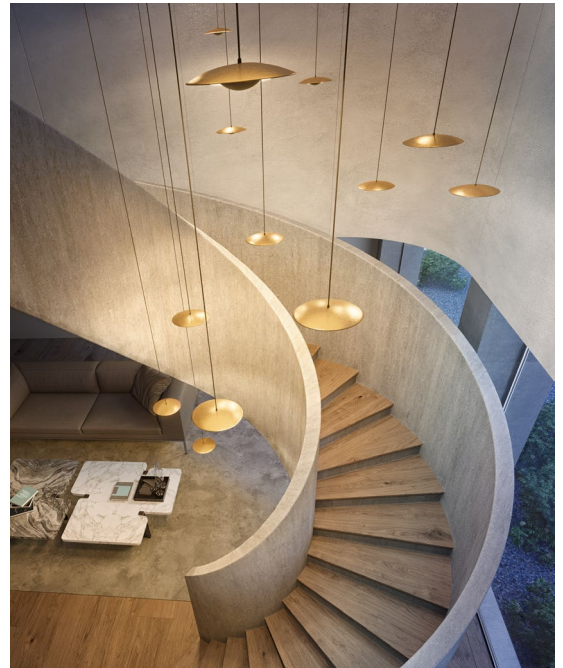

**Ginger 20 - 24V**

Light source: LED SMD 24Vdc 5W 2700K CRI90 495lm  
Luminaire: (Power supply not included) 161lm

**Wire entry points**

Canopy 20W/ Circular	3
Canopy 50W/ Circular	5
Canopy 50W/ Rectangular	9
Canopy 50W/ Circular	9
Canopy 100W/ Circular	19

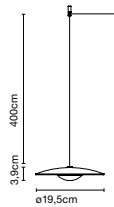

Black electrical cord

This system makes it possible to connect several suspension lamps into a single point of light, offering the absolute freedom to build with light. The Cluster accessory helps to illuminate large spaces or create compositions with the Dipping Light collection or the Ginger 20 model.

### How Ginger illuminates

