



Paulmann



31.08.2021
ENERGY LABEL 874/2012
A++ - A

01.09.2021
ENERGY LABEL 2019/2015
F

LED symbols and www.paulmann.com/symbols

Paulmann Licht GmbH
Quezinger Feld 2
31832 Springe
Germany
www.paulmann.com

Art.-Nr.: 798.84

PSU 09/22

CE UK CA

1x

1x

Incl.

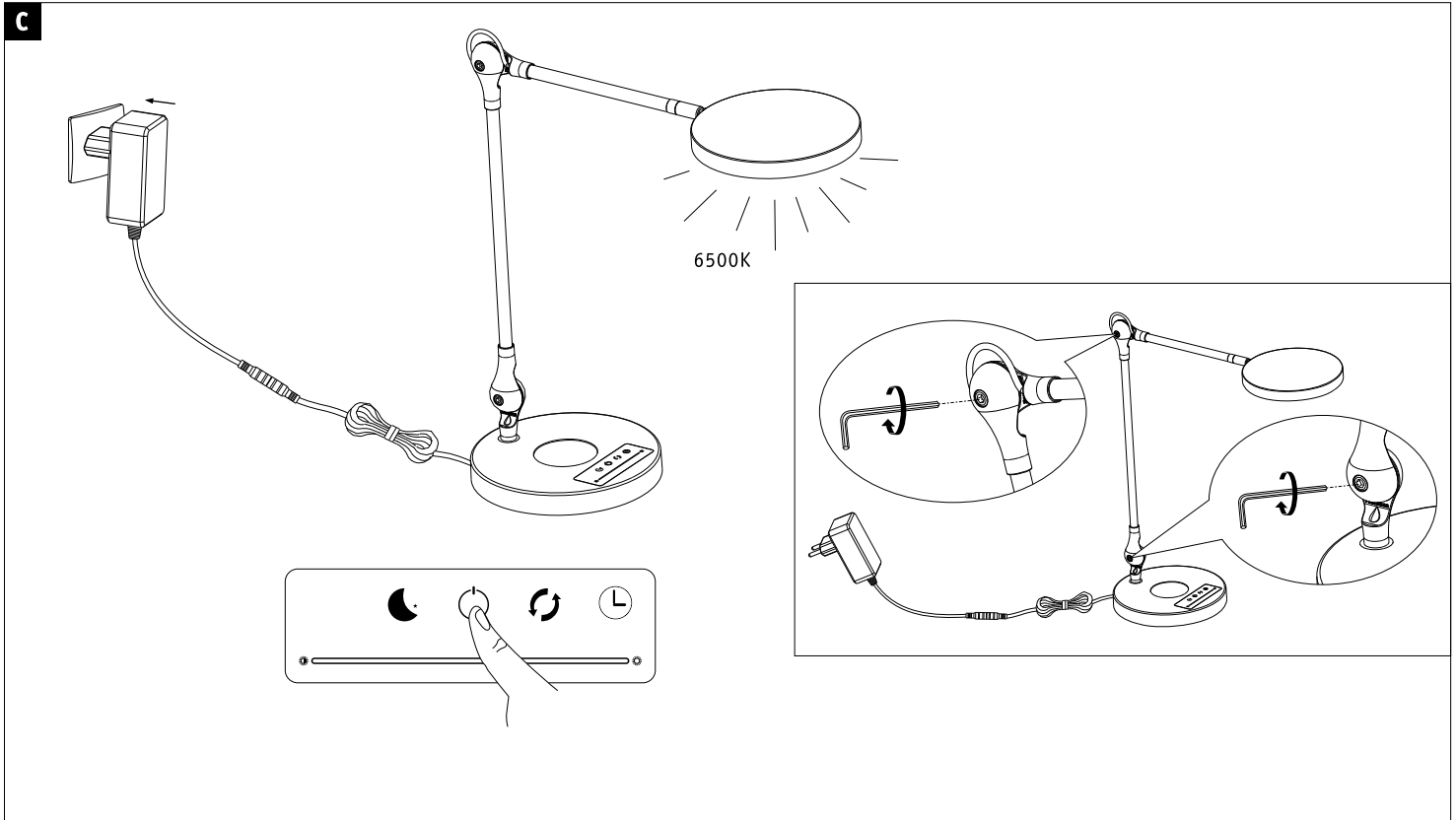
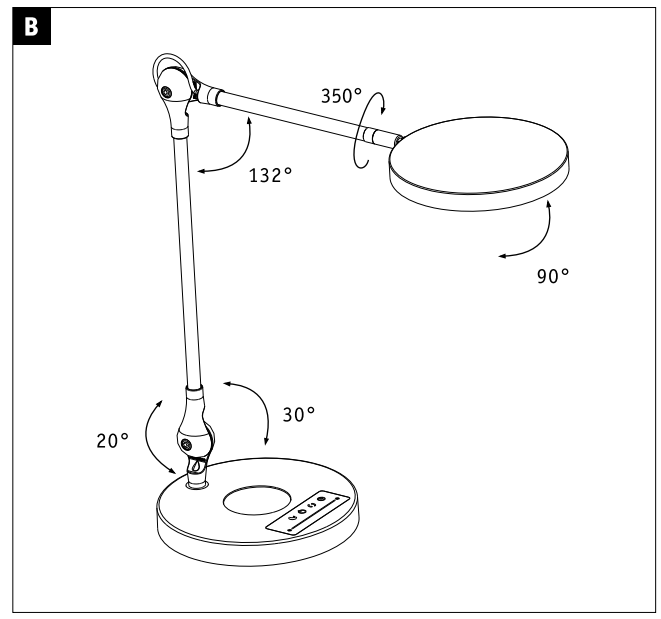
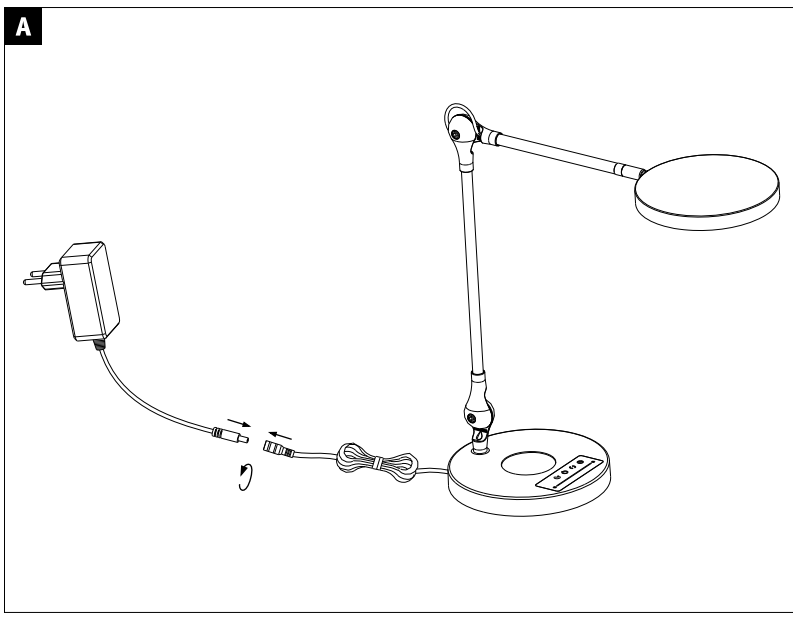

D1

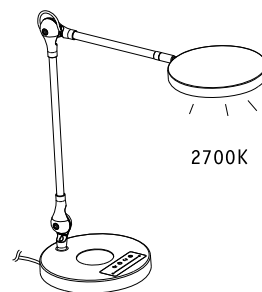
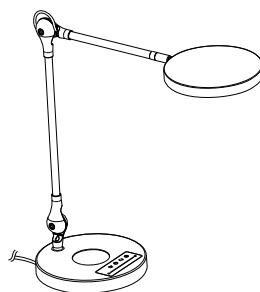
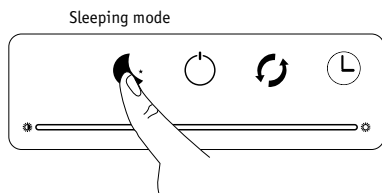

D2

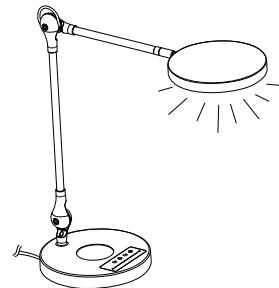
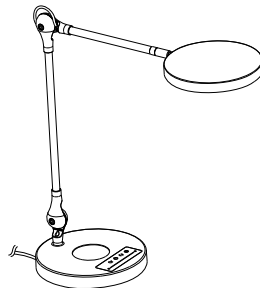
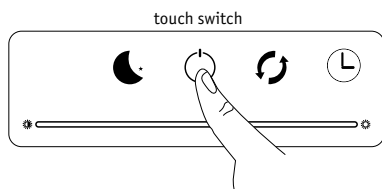

D3

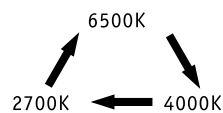
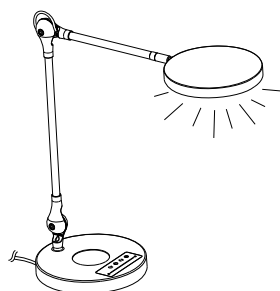
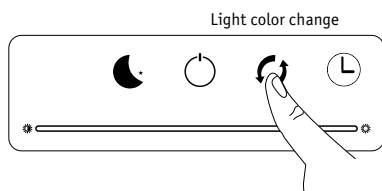

D4

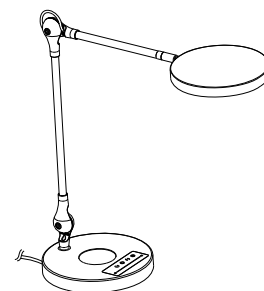
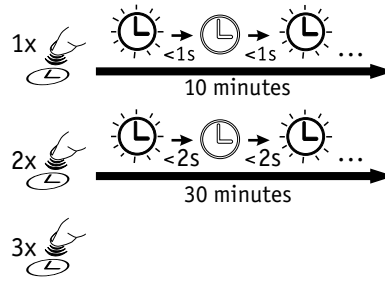
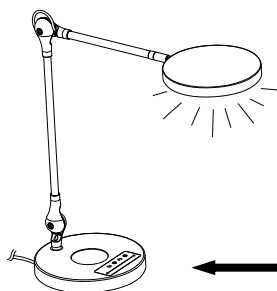
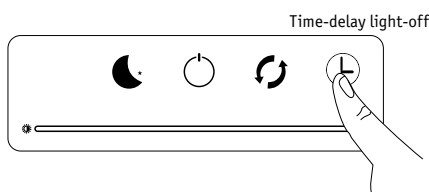

D5

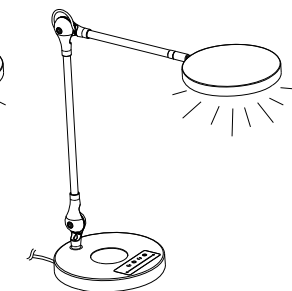
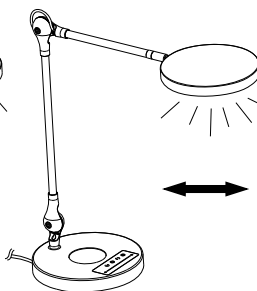
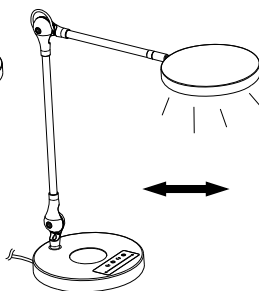
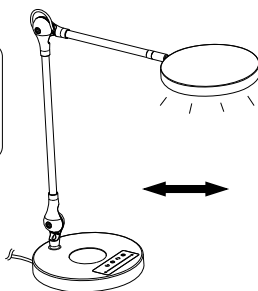
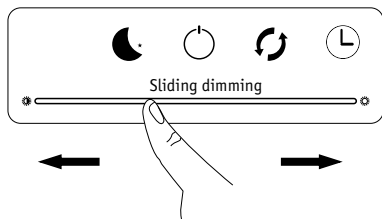

D6

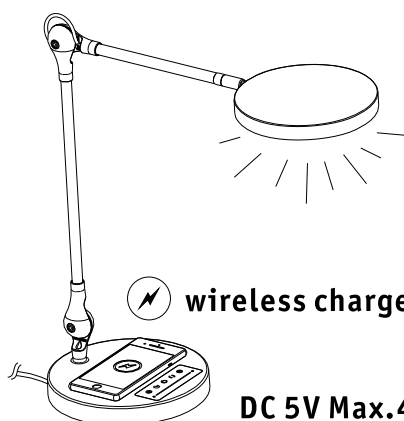

DC 5V Max.4.5W

