

9616086

15,8W LED / 15,8W Total
incl. LED Board: L9001387
230V ~ 50Hz



(DE) Bestimmungsgemäße Verwendung

(EN) Intended use | (FR) Utilisation conforme | (NL) Beoogd gebruik | (PL) Stosowanie zgodnie z przeznaczeniem | (NO) Riktig bruk | (DK) Korrekt brug
(SE) Avsedd användning | (FI) Määräystenmukainen käyttö | (IT) Impiego appropriato | (ES) Uso prescrito | (CZ) Použití v souladu s určením
(PT) Utilização correta | (GR) Ενδεδειγμένη χρήση | (SK) Predpokladané použitie | (EE) Eeldatav kasutus | (LV) Paredzams lietojums
(LT) Numatomas naudojimas | (RO) Utilizare intenționată | (SI) Predvidena uporaba | (HR) Namjenska upotreba | (HU) Tervezett felhasználás
(BG) предназначена употреба | (AL) Përdorimi i parashikuar | (MK) Предвидена употреба | (TR) Amaçlı kullanım | (UK) Призначене використання
(BA,ME,RS) Namjenska upotreba

(DE)	Ortsfeste Verwendung an Wegen/in Beeten im Außenbereich	(GB)	For stationary use outdoors on paths or in flower beds
(FR)	Pose fixe le long des allées/des parterres de plantes, à l'extérieur	(NL)	Vast gebruik langs paden en bloembedden buitenshuis
(PL)	Do montażu stacjonarnego na zewnątrz przy drogach/ grządkach	(NO)	Til stasjonært bruk på veier og i bed utendørs
(DK)	Til stationær brug på veje og i bed udendørs	(SE)	Fast användning vid stigar/rabatter utomhus
(FI)	Kiinteä käyttö ulkotilojen kulkureiteillä/kukkapenkeissä	(IT)	Impiego fisso su sentieri/aiuole in ambienti esterni
(ES)	Empleo fijo en caminos / jardineras en el exterior	(CZ)	Stacionární použití jako cestiček u záhonů v exteriéru
(PT)	Aplicação fixa para caminhos/ canteiros em exteriores	(GR)	Σταθερή χρήση σε διαδρόμους/παρτέρια σε εξωτερικό χώρο
(SK)	Na stacionárne použitie vo vonkajšom prostredí na chodníkoch alebo v záhonoch	(BG)	За стационарна употреба на открито по пътеки или в цветни лехи
(EE)	Statsionaarseks kasutamiseks õues radadel või lillepeenardel	(LV)	Stacionārai izmantošanai ārpus telpām uz celiņiem vai puķu dobēs
(LT)	Stacionariam naudojimui lauke ant takų arba gėlynuose	(RO)	Pentru utilizare staționară în exterior pe alei sau în straturile de flori
(SI)	Za stacionarno uporabo na prostem na poteh ali cvetličnih gredah	(HR)	Za stacionarnu upotrebu vani na stazama ili u cvjetnim gredicama
(HU)	Helyhez kötött használatra kültéren utakon vagy virágágyásokban	(AL)	Për përdorim të palëvizshëm jashtë në rrugë ose në kopshte lulesh
(MK)	За стационарна употреба надвор на патеки или во цветни градини	(TR)	Yollarda veya çiçek yataklarında durağan kullanım için
(UK)	Для стациoнарного використання на вулицях або в квіткових клумбах	(BA)	Za stacionarnu upotrebu na stazama ili u cvjetnim gredicama
		(ME)	
		(RS)	

(DE) Lieferumfang		
(EN) Package contents (FR) Contenu de la livraison (NL) Bij de levering inbegrepen (PL) Zakres dostawy (NO) Levering (DK) Leveringsomfang (SE) Leveransomfattning (FI) Toimitussisältö (IT) Fornitura (ES) Volumen de suministro (CZ) Rozsah dodávky (PT) Material fornecido (GR) Παραδοτέος εξοπλισμός (SK) Obsah balenia (EE) Pakendi sisu (LV) Pakas saturs (LT) Pakuotės turinys (RO) Conținutul pachetului (SI) Vsebina paketa (HR) Sadržaj paketa (HU) A csomag tartalma (BG) обхват на доставката (AL) Përmbajtja e dorëzimit (MK) Содржина на испорака (TR) Teslimat içeriği (UK) Зміст доставки (BA,ME,RS) Sadržaj isporuke		
(DE) 1 Wegeleuchte Montagematerial Montageanleitung	(GB) 1 Path light Installation hardware Mounting instructions	(FR) 1 Borne lumineuse Matériel de montage Instructions de montage
(NL) 1 Padverlichting Monteringsmateriale Montagehandleiding	(PL) 1 Śtupek oświetleniowy Elementy montażowe Instrukcja montażu	(NO) 1 Gatelampe Monteringsmateriale Brukerveiledning
(DK) 1 Gadelys Monteringsmateriale Brugervejledning	(SE) 1 Väglykta Monteringsmaterial Monteringsanvisning	(FI) 1 Pylväsvalaisin Asennusmateriaali Asennusohjeet
(IT) 1 Lampioncino Materiale di montaggio Istruzioni di montaggio	(ES) 1 Lámpara para caminos Material de montaje Instrucciones de montaje	(CZ) 1 Osvětlení cestíček Materiál pro montáž Návod k montáži
(PT) 1 Luminária técnica Material de montagem Instruções de montagem	(GR) 1 Φωτιστικό διαδρόμων Υλικό συναρμολόγησης Οδηγίες συναρμολόγησης	(SK) 1 cestné svetlo Inštaláčny hardvér Inštaláčná príručka
(BG) 1 светлина за пътека материали за монтаж инструкции за монтаж	(EE) 1 teevalgusti Paigaldustarvikud Paigaldusjuhend	(LV) 1 ceļa gaisma Instalācijas aparatūra Uzstādīšanas instrukcija
(LT) 1 kelio žibintas Montavimo aparatinė įranga Montavimo instrukcija	(RO) 1 lampă de cărare Hardware de instalare Instrucțiuni de montare	(SI) 1 svetilka za pot Namestitvena strojna oprema Navodila za montažo
(HR) 1 svjetlo staze Instalacijski hardver Upute za montažu	(HU) 1 ösvény világítás Telepítési hardver Szerelési útmutató	(AL) 1 dritë për rrugë Materiali i montimit Udhëzuesi i montimit
(MK) 1 светло за патека Монтажен материјал Упатство за монтажа	(TR) 1 yol lambası Montaj malzemesi Montaj kılavuzu	(UK) 1 світло для стежки Монтажний матеріал Інструкція з монтажу
(BA) 1 svjetlo za stazu (ME) Montažni materijal (RS) Uputstvo za montažu		

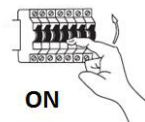
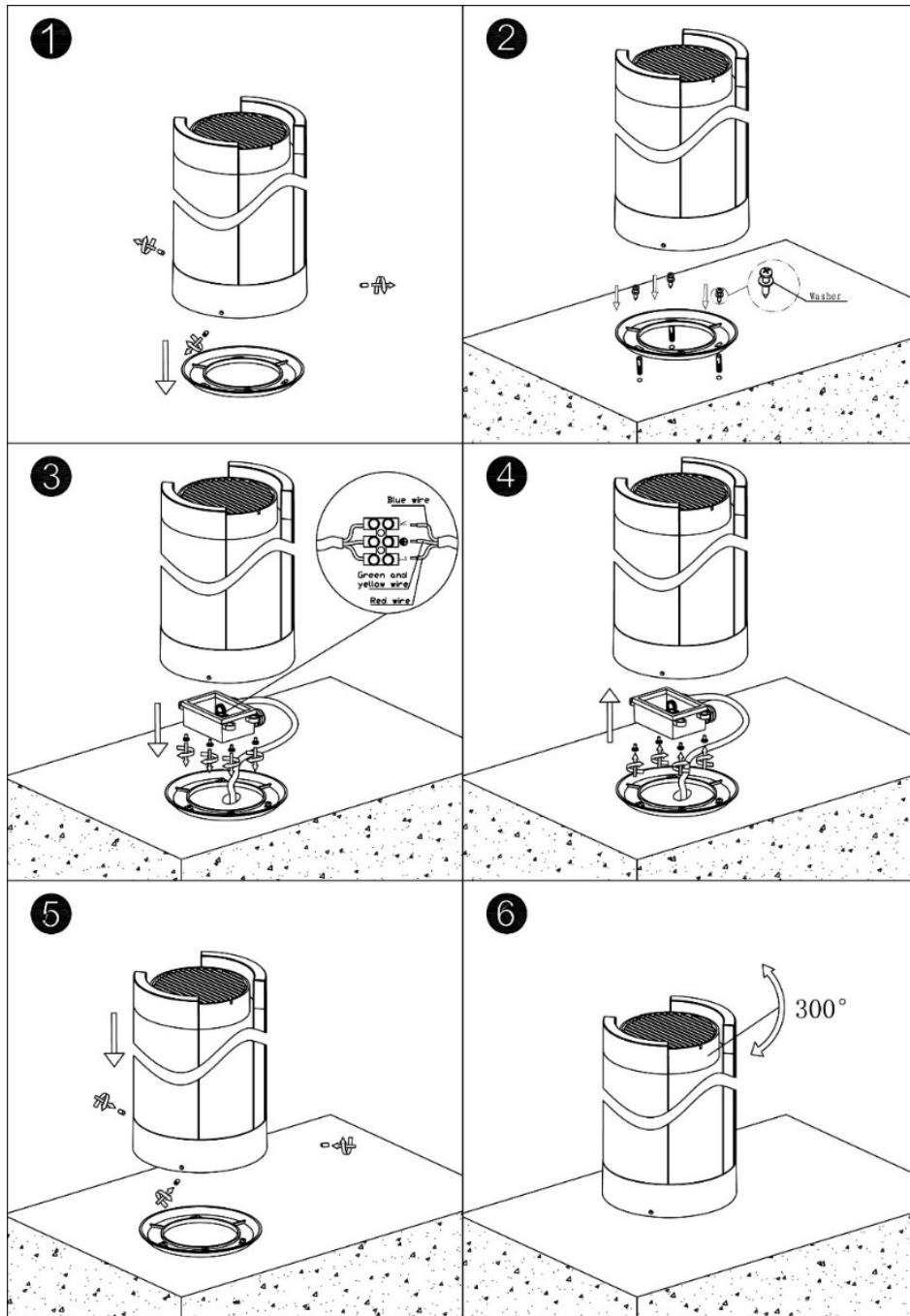
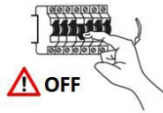

	(DE)	(EN)	(FR)	(NL)	(PL)	(NO)
L	Stromführender Leiter	Live conductor	Conducteur	Spanningvoerende draad	Przewód prądowy	Strømførende leder
	Schutzleiter	Earth conductor	Conducteur de protection (terre)	Aardkabel	Przewód uziemiający	Jordledningen
N	Neutralleiter	Neutral conductor	Conducteur neutre	Nulleider	Przewód zerowy	Nøytralleider

	(DK)	(SE)	(FI)	(IT)	(ES)	(CZ)
L	Strømførende leder	Strömförande ledare	Virtajohdin	Conduttore sotto tensione	Conductor de corriente	Vodič pod napětím
	Jordledningen	Skyddsledare	Suojajohdin	Conduttore di terra	Conductor de protección	Ochranný vodič
N	Neutralleider	Neutralledare	Nollajohdin	Conduttore neutro	Conductor neutro	Neutrální vodič

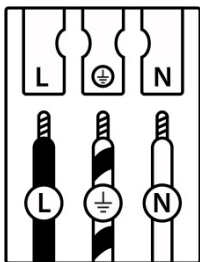

	(PT)	(GR)	(SK)	(EE)	(LV)	(LT)
L	Condutor vivo	Ρευματοφόρος αγωγός	Živý vodič	Faasisjuht	Dzīvais vadītājs	Gyvas dirigentas
	Condutor de terra	Αγωγός γείωσης	Zemný vodič	Maandusjuht	Zemes vadītājs	Žemės dirigentas
N	Condutor neutro	Ουδέτερος αγωγός	Neutrálny vodič	Neutraaljuht	Neitrālais vadītājs	Neutrinis dirigentas

	(RO)	(SI)	(HR)	(HU)	(BG)	(AL)
L	Conductor viu	Živi dirigent	Živi dirigent	Élő vezető	проводник под напряжение	Konduktor i gjallë
	Conductor de împământare	Zemeljski dirigent	Uzemljeni dirigent	Földvezető	защитен проводник	Dirigjent i tokës
N	Conductor neutru	Nevtralni dirigent	Neutralni dirigent	Semleges vezető	нулев проводник	Kondaktor neutral

	(MK)	(TR)	(UK)	(BA)(ME)(RS)
L	Жив кондуктор	Canlı yönetici	Живий диригент	Živi dirigent
	Земјен проводник	Toprak iletkeni	Земельний провідник	Zemaljski provodnik
N	Неутрален проводник	Nötr iletken	Нейтральний провідник	Neutralni provodnik

(DE) Verwendete Symbole

(EN) Safety Precautions | (FR) Symboles utilisés | (NL) Gebruikte symbolen | (PL) Stosowane symbole | (NO) Brukte symboler | (DK) Brugte symboler | (SE) Använda symboler | (FI) Käytetyt symbolit | (IT) Simboli usati | (ES) Símbolos empleados | (CZ) Použité symboly | (PT) Símbolos utilizados | (GR) Χρησιμοποιούμενα σύμβολα | (SK) Bezpečnostné opatrenia | (EE) Ohutusabinõud | (LV) Drošības pasākumi | (LT) Saugos priemonės | (RO) Măsuri de precauție | (SI) Varnostni ukrepi | (HR) Mjere opreza | (HU) Használt szimbólumok | (BG) Мерки за безопасност | (AL) Simbolet e përdorura | (MK) Користени симболи | (TR) Kullanılan semboller | (UK) Використовувані символи | (BA,ME,RS) Korišteni simboli

IP 65

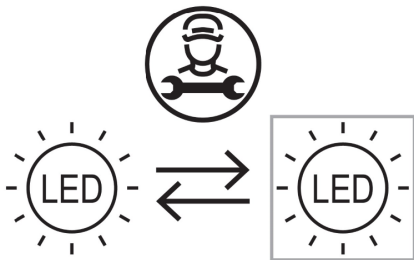

<p>(DE) Dieses Produkt enthält eine Lichtquelle der Energieeffizienzklasse E (EN) This product contains a light source of energy efficiency class E (FR) Ce produit comprend une source de lumière de classe d'efficacité énergétique E (NL) Dit product bevat een lichtbron van energie-efficiëntieklasse E (PL) Produkt ten zawiera źródło światła o klasie efektywności energetycznej E (NO) Dette produktet inneholder en lyskilde i energieeffektivitetsklasse E (DK) Dette produkt indeholder en lyskilde af energieeffektklasse E (SE) Denna produkt innehåller en ljuskälla i energieffektivitetsklass E (FI) Tämä tuote sisältää energiatehokkuusluokan E valonlähteen (IT) Questo prodotto contiene una sorgente luminosa della classe di efficienza energetica E (ES) Este producto contiene una fuente de luz de la clase de eficiencia energética E (CZ) Tento výrobek obsahuje světelný zdroj třídy energetické účinnosti E (PT) Este produto contém uma fonte de luz da classe de eficiência energética E (GR) Αυτό το προϊόν περιέχει μια φωτεινή πηγή ενεργειακής απόδοσης κλάσης E (SK) Tento výrobok obsahuje zdroj svetla triedy energetickej efektivity E (EE) See toode sisaldab energiatõhususklassi E valgusallikat (LV) Šis produkts satur enerģijas efektivitātes klases E gaismas avotu (LT) Šis gaminys turi energijos efektyvumo klasės E šviesos šaltinį (RO) Acest produs conține o sursă de lumină de clasă de eficiență energetică E (SI) Ta izdelek vsebuje svetlobni vir energijskega razreda E (HR) Ovaj proizvod sadrži izvor svjetlosti energetske učinkovitosti klase E (HU) Ez a termék egy E energiahatékonysági osztályú fényforrást tartalmaz (BG) Този продукт съдържа източник на светлина с клас на енергийна ефективност: E (AL) Ky produkt përmban një burim drite të klasës së efikasitetit të energjisë E (MK) Овој производ содржи извор на светлина од класа на енергетска ефикасност E (TR) Bu ürün, enerji verimliliği sınıfı E olan bir ışık kaynağı içerir (UK) Цей продукт містить джерело світла класу енергоефективності E (BA)(ME)(RS) Ovaj proizvod sadrži izvor svjetlosti energetske klase E</p>	<p style="text-align: center;">QR</p> 	<p style="text-align: center;">EAN</p> <p style="text-align: center;">4251911717204</p>
--	--	--

	<p>(DE) Durch einen Fachmann austauschbare Lichtquelle (nur LED). (EN) Replaceable (LED only) light source by a professional. (FR) Source de lumière remplaçable (LED uniquement) par un professionnel. (NL) Lichtbron (alleen led) te vervangen door een professional. (PL) Wymienne (tylko LED) źródło światła wykonane przez profesjonalistę. (NO) Utskiftbar (kun LED) lyskilde av en profesjonell. (DK) Udskiftelig lyskilde (kun LED), udskiftes af en elektriker. (SE) Ljuskälla (endast LED) utbytbar genom fackman. (FI) Ammattilainen voi vaihtaa vaihdettavan (vain LED) valonlähteen. (IT) Sorgente luminosa (solo LED) sostituibile da un professionista. (ES) Fuente de luz (solo LED) sustituible por un profesional. (CZ) Vyměnitelný (pouze LED) světelný zdroj odborníkem. (PT) Luz LED (apenas LED) substituível por um profissional. (GR) Η πηγή φωτός (μόνο LED) να αντικαθίσταται από επαγγελματία. (SK) Zdroj svetla (iba LED) vymeniteľný prostredníctvom odborníka. (EE) Spetsialisti poolt vahetatav valgusallikas (ainult LED). (LV) Speciālista maināms gaismas avots (tikai LED). (LT) Specialisto keičiamas šviesos šaltinis (tik LED). (RO) Sursă de lumină schimbabilă de către un specialist (doar LED). (SI) Svetlobni vir, ki ga lahko zamenja strokovnjak (samo LED). (HR) Izvor svjetlosti koji može zamijeniti stručnjak (samo LED). (HU) Szakember által cserélhető (csak LED) fényforrás. (BG) Светлинен източник, който може да се смени от специалист (само LED). (AL) Burim drite i zëvendësueshëm (LED vetëm) nga një profesionist. (MK) Изворот на светлина (само LED) се заменува од професионалец. (TR) Değiştirilebilir (yalnızca LED) ışık kaynağı bir profesyonel tarafından değiştirilir. (UK) Замінний (тільки LED) джерело світла замінюється фахівцем. (BA)(ME)(RS) Zamjenjiv (samo LED) izvor svjetlosti zamjenjuje profesionalac.</p>
---	--