

GB Products with electronic ballasts / drivers must not be installed on the same electrical circuits as products with inductive loads, for example magnetic fluorescent luminaires, motors or ventilators. Inductive loads can generate excessive voltage surges which can damage electronic ballasts.

The light source in this luminaire shall only be replaced by the manufacturer or his service agent or a similar qualified person.

PLEASE READ THE INSTRUCTIONS CAREFULLY
BEFORE COMMENCING ASSEMBLY

Live: Normally Brown / Red
Neutral: Normally Blue / Black
Earth: Normally Green / Yellow

This product contains a light source of energy efficiency class F to Regulation (EU) No 2019/2015 (01/09/2021)

FR Les luminaires utilisant un ballast électronique / drivers ne peuvent être installés sur le même circuit que des appareils avec charges inductives, tels que luminaires fluorescents magnétiques, moteurs et ventilateurs. Les charges inductives peuvent générer des voltages excessifs et ainsi endommager les ballasts électroniques.

La source lumineuse de ce luminaire devrait seulement être remplacée par le fabricant ou par un de ses agents de maintenance ou par une personne qualifiée similaire.

LIRE ATTENTIVEMENT LES INSTRUCTIONS
AVANT DE COMMENCER LE MONTAGE

Phase: Normalement Brun / Rouge
Neutre: Normalement Bleu / Noir
Terre: Normalement Vert / Jaune

Ce produit contient une source lumineuse de classe d'efficacité énergétique F selon le règlement (UE) n° 2019/2015 (01/09/2021)

IT Tutti i prodotti che includono ballast elettronici / driver non devono essere installati sugli stessi circuiti elettrici come anche prodotti con carichi induttivi quali lampadari a fluorescenza magnetica, motori o ventilatori. I carichi induttivi possono generare scariche eccessive che possono danneggiare i ballast.

La sorgente di luce in questo apparecchio può essere sostituita solo dal produttore o da un suo agente di servizio o da una persona qualificata simile.

LEGGERE ATTENTAMENTE LE ISTRUZIONI
PRIMA DI COMINCIARE L'ASSEMBLAGGIO

Cavo positivo: normalmente marrone o rosso
Cavo neutro: normalmente blu o nero
Cavo terra: normalmente verde o giallo

Questo prodotto contiene una sorgente luminosa di classe di efficienza energetica F secondo il regolamento (UE) n° 2019/2015 (01/09/2021)

DE Produkte mit elektronischen Vorschaltgeräten/ Treibern dürfen nicht im selben Stromkreislauf installiert werden wie Verbraucher mit induktiven Lasten, z.B. magnetische Leuchtstofflampen, Motoren oder Ventilatoren. Induktive Lasten können übermäßige Spannungsspitzen erzeugen, die elektronische Vorschaltgeräte beschädigen könnten.

Die Lichtquelle in dieser Leuchte darf nur vom Hersteller oder seinem Servicemitarbeiter oder einer ähnlich qualifizierten Person ausgetauscht werden.

LESEN SIE BITTE DIE ANWEISUNGEN
SORGFÄLTIG DURCH, BEVOR SIE MIT DEM
ZUSAMMENBAUEN BEGINNEN

Phase: Normalerweise Braun / Rot
Nulleiter: Normalerweise Blau / Schwarz
Erde: Normalerweise Grün / Gelb

Dieses Produkt enthält eine Lichtquelle der Energieeffizienzklasse F gemäß Verordnung (EU) Nr. 2019/2015 (01/09/2021)

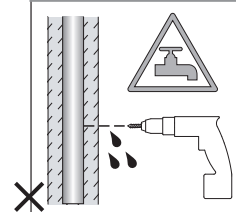
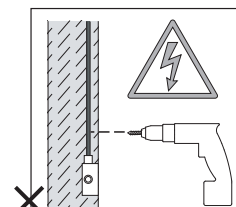
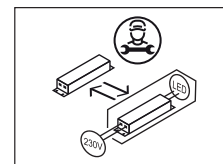
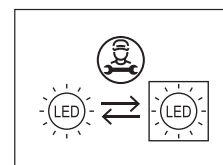

FOR WALL USE ONLY
Usage mural uniquement
Solo per uso a parete
Nur zur Verwendung als Wandleuchte



UNSUITABLE FOR DIMMING
Ne convient pour gradateur
Non dimmerabile
Nicht zum Dimmen geeignet

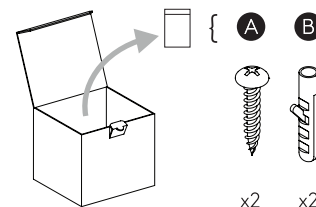
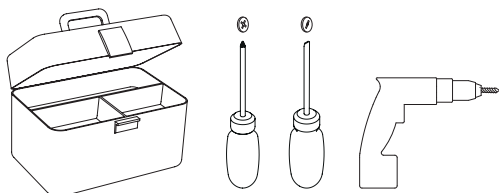

x2

x2

1

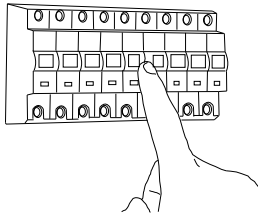

TURN OFF POWER
 Couper Le Courant! /
 Strom Abhalten! /
 Corte La Corriente!

2

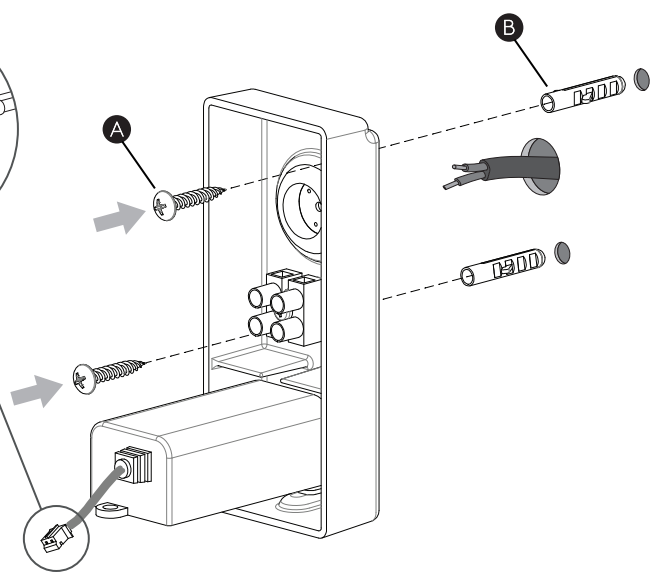
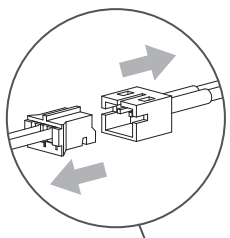

3

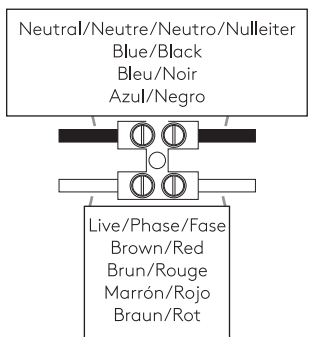

4

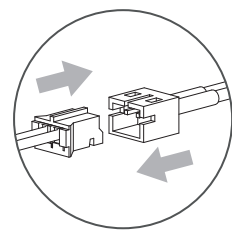

5

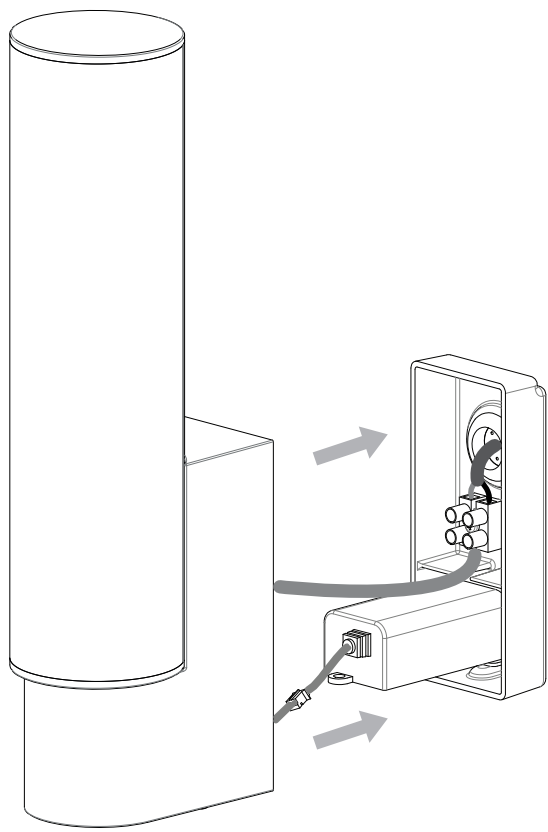

6

