

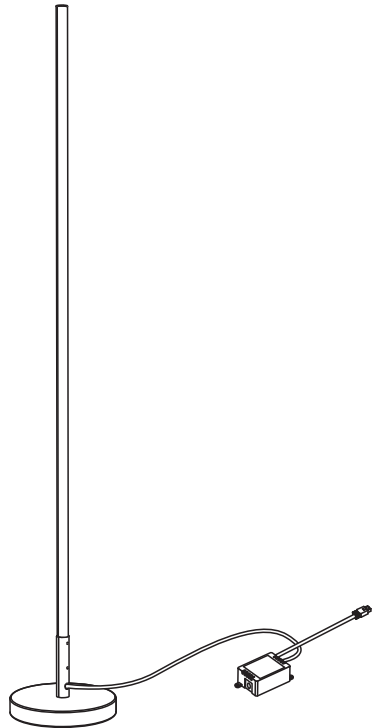

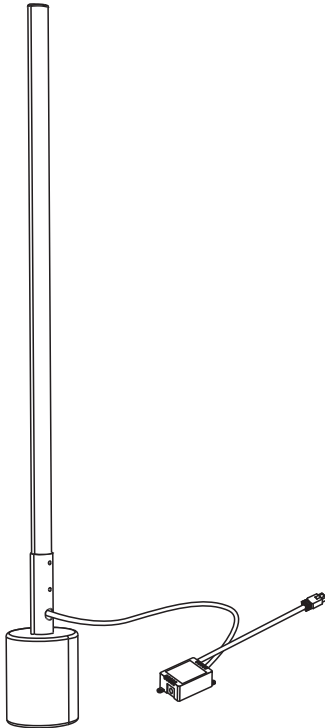







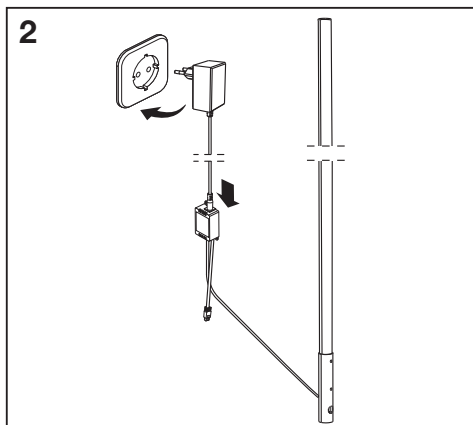
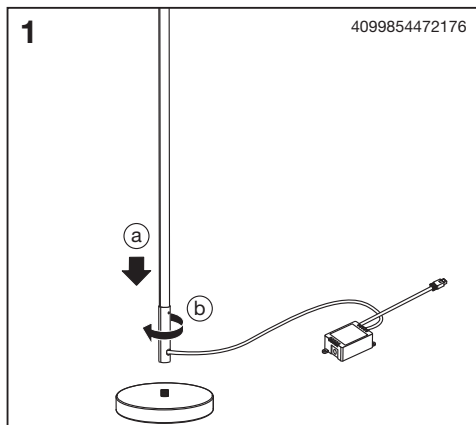
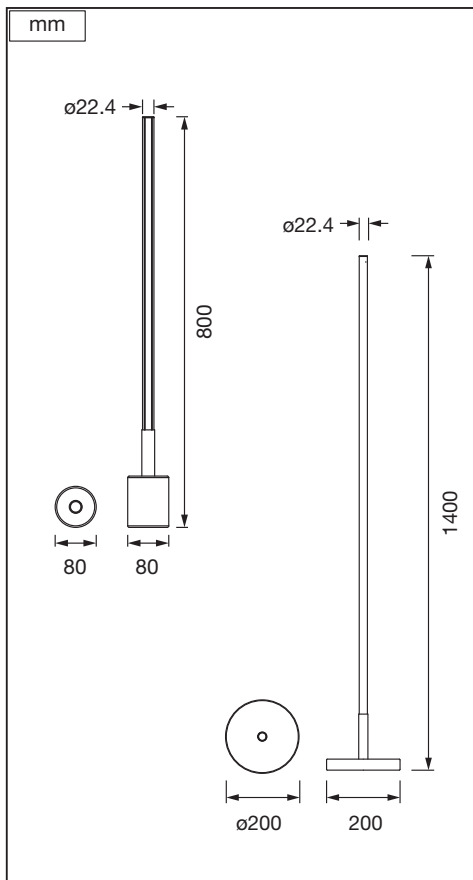
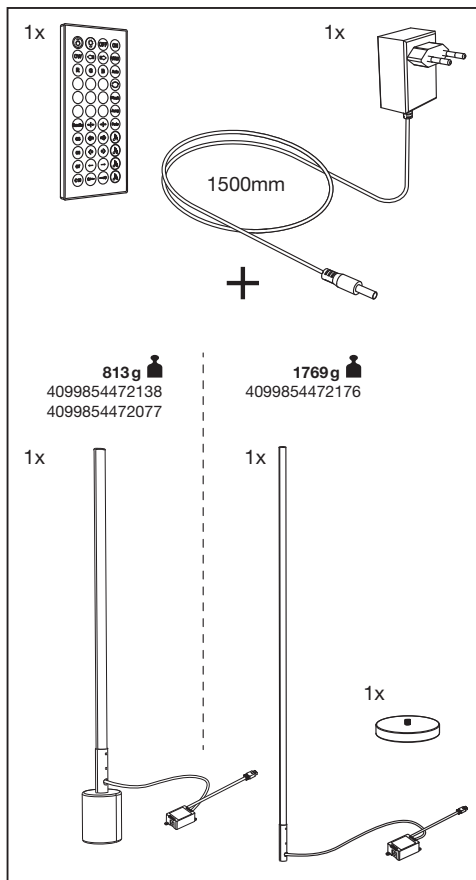

























## SMART<sup>+</sup> WIFI FLOOR



	EAN	W	lm light source	lm output	K	⊖(°C)	V~	mA	Hz	PF	DF	▽ (°)	
SMART WIFI FLOOR CORNERSLIM RGBTWWT	4099854472138	8	540	280	2700- 6500	-20...+40	220- 240	50	50/60	>0.5	>0.7	120	15000
SMART WIFI FLOOR CORNERSLIM RGBTWBK	4099854472077	8	540	180	2700- 6500	-20...+40	220- 240	50	50/60	>0.5	>0.7	120	15000
SMART WIFI FLOOR ROUND RGBTW BK	4099854472176	14	1170	350	2700- 6500	-20...+40	220- 240	80	50/60	>0.5	>0.7	120	15000



					
	EAN	n			<b>ENERGY</b> * X =
<b>SMART WIFI FLOOR CORNERSLIM RGBTWWT</b>	4099854472138	6	AC42115		E
<b>SMART WIFI FLOOR CORNERSLIM RGBTWBK</b>	4099854472077	6	AC42115		E
<b>SMART WIFI FLOOR ROUND RGBTW BK</b>	4099854472176	13	AC42115		E

\*  Dieses Produkt enthält eine Lichtquelle der Energieeffizienzklasse <X>.  This product contains a light source of energy efficiency class <X>.  Ce produit contient une source lumineuse de classe d'efficacité énergétique <X>.  Questo prodotto contiene una sorgente luminosa di classe di efficienza energetica <X>.  Este producto contiene una fuente luminosa de la clase de eficiencia energética <X>.  Este produto contém uma fonte de luz da classe de eficiência energética <X>.  Το προϊόν αυτό περιέχει φωτιστή πληγής της τάξης ενεργειακής απόδοσης <X>.  Dit product bevat een lichtbron van energie-efficiëntieklasse <X>.  Denna produkt innehåller en ljuskälla med energieffektivitetsklass <X>.  Tämä tuote sisältää valonlähteen, jonka energiatehokkuusluokka on <X>.  Dette produkt indeholder en lyskilde i energieffektivitetsklasse <X>.  Tento výrobek obsahuje světelný zdroj s třídou energetické účinnosti <X>.  Данный продукт содержит энергосберегающий источник света (класса <X>).  Ez a termék egy <X> energiatékonysági osztályú fényforrást tartalmaz.  Ten produkt zawiera źródło światła o klasie efektywności energetycznej <X>.  Tento výrobek obsahuje svetelný zdroj triedy energetickej účinnosti <X>.  Ta izdelek vsebuje svetlobni vir razreda enerjske učinkovitosti <X>.  Bu ürün, enerji verimliliği sınıfında bir ışık kaynağıdır <X>.  Ovaj proizvod sadržiava izvor svetlosti klase energetske učinkovitosti <X>.  Acest produs conține o sursă de lumină cu clasa de eficiență energetică <X>.  Тоzi продукт включва светлинен източник с клас на енергийна ефективност <X>.  Toode sisaldab energiatõhususe klassi <X> valgusallikat.  Šiame gaminyje yra šviesos šaltinis, kurio energijos vartojimo efektyvumo klasė <X>.  Ši s ražojums satur gaismas avotu, kura energoefektivitātes klase ir <X>.  Ovaj proizvod sadrži izvor svetlosti klase energetske efikasnosti <X>.  Цей виріб містить джерело світла класу енергоефективності <X>.  Бул өнімде <X> энергия тиімділігі класының жарық көзі бар.

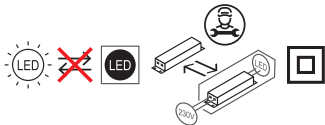

Points de collecte sur [www.quefairedemesdechets.fr](http://www.quefairedemesdechets.fr)

G11226626  
19.03.2025



LEDVANCE SASU  
CQM, 5 rue d'Altorf  
67120 Molsheim France  
[www.ledvance.com](http://www.ledvance.com)

© LEDVANCE Ltd, Sterling House,  
810 Mandarin Court, Warrington,  
Cheshire, WA1 1GG, United Kingdom