

- INSTRUCTION MANUAL -

PC PORTABLE

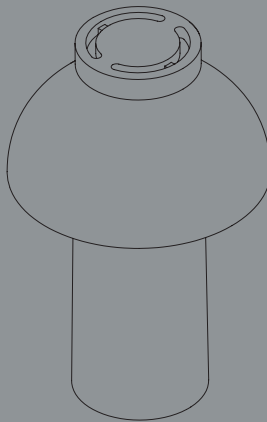

DESIGN BY PIERRE CHARPIN

HAY

TECHNICAL DATA

This product is fitted with a low voltage LED (DC 3.7V) bulb fitting and supplied with a suitable LED bulb. HAY recommends using the supplied bulb with this lamp.

FITTING TYPE | Low voltage LED G4

POWER (W) | 3 W

COLOUR TEMPERATURE | 3000K warm white

For replacements of LED bulbs, please contact HAY or an authorised dealer. HAY will not accept any responsibility for any accidents, injuries or damages that occur due to the use of incorrect bulbs.

- Max. charge voltage of battery: 4.25V
- Max. charging current: 1000mA
- Max. discharge current: 520mA

ATTENTION

The product must not be modified in any way. HAY accepts no responsibility for any products that have been modified or tampered with. If the external USB charging cable is damaged it should be replaced immediately. This lamp is designed for indoor and outdoor use. HAY recommends that the lamp is not kept outside while raining.

This lamp has an integrated high-performance lithiumion battery. When charging the battery, use a USB power source/driver with low voltage (SELV) output with a constant voltage of 5V, input current not more than 2A, according to IEC/EN 61347-2-13. After 300 charging cycles, it will maintain a capacity of 75% or more.

To extend battery life, it is recommended to regularly charge it with the supplied USB cable. The battery in this lamp is non-replaceable. The battery must be removed from the lamp and disposed of safely before the lamp is disposed of. Before removing the battery, make sure that the lamp is not plugged into a power source. Please read all instructions before installing the lamp.

NOTE | This equipment has been tested and found to comply with the limits for a Class B digital device, pursuant to part 15 of the FCC Rules. These limits are designed to provide reasonable protection against harmful interference in a residential installation. This equipment generates, uses and can radiate radio frequency energy and, if not installed and used in accordance with the instructions, may cause harmful interference to radio communications. However, there is no guarantee that interference will not occur in a particular installation. If this equipment does cause harmful interference to radio or television reception, which can be determined by turning the equipment off and on, the user is encouraged to try to correct the interference by one or more of the following measures:

- Reorient or relocate the receiving antenna.
- Increase the distance between the equipment and receiver.
- Connect the equipment to an outlet on a different circuit to the one the receiver is connected to.
- Consult the dealer or an experienced radio/TV technician for help.



CAUTION | Changes or modifications to this unit not expressly approved by the party responsible for compliance could void the user's authority to operate the equipment. This device complies with part 15 of the FCC Rules. Operation is subject to the following two conditions:

- This device may not cause harmful interference.
- This device must accept any interference received, including interference that may cause undesired operation.

WARNING | When using outdoor use portable luminaires, basic safety precautions should always be followed to reduce the risk of fire, electric shock and personal injury, including the following:

- Use only three-wire outdoor extension cords that have three-prong grounding plugs and grounding receptacles that accept the appliance's plug.
- Ground Fault Circuit Interrupter (GFCI) protection is to be provided on the circuit(s) or outlet(s) to be used for the wet location portable luminaire. Receptacles are available having built-in GFCI protection and are able to be used for this measure of safety.
- Use only with an extension cord for outdoor use, such as an extension cord of cord type SEW, SEOW, SEOWW, SOW, SOOW, STW, STOW, STOOW, SJEW, SJEOW, SJEOWW, SJW, SJOW, SJOOW, SJTW, SJTOW, or SJTOOW.
- Suitable for damp and wet locations.
- Do not submerge.

CARE AND MAINTENANCE

The product can be cleaned with a soft damp cloth and mild detergent, or a dry microfibre cloth. Do not use alcohol or any other solvents to clean the product and avoid using abrasive or rough sponges. Ensure that the power supply has been turned OFF before cleaning the product.

- PARTS -

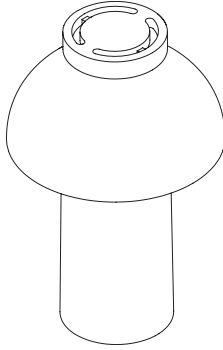

Lamp



LED Bulb

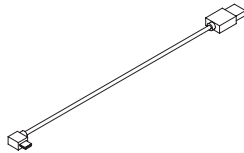

USB Power Cable

1.

Unpack all the parts and check that you have received all the parts listed.
Remove the shade by turning it counterclockwise and then lifting it off the lamp base.

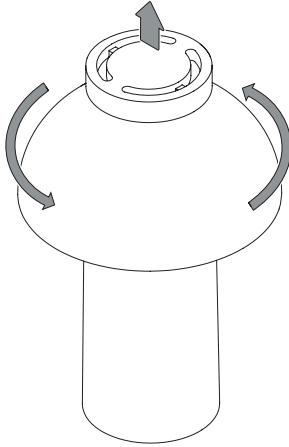

2.

Locate the supplied bulb, remove it from its packaging and place it into the bulb fitting, located in the lamp base. For replacement bulb options, please refer to the HAY website.

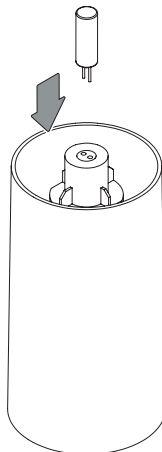

3.

Place the shade onto the lamp base, aligning the grooves on the shade with the bayonet fitting inside the lamp base. Turn clockwise and tighten securely.

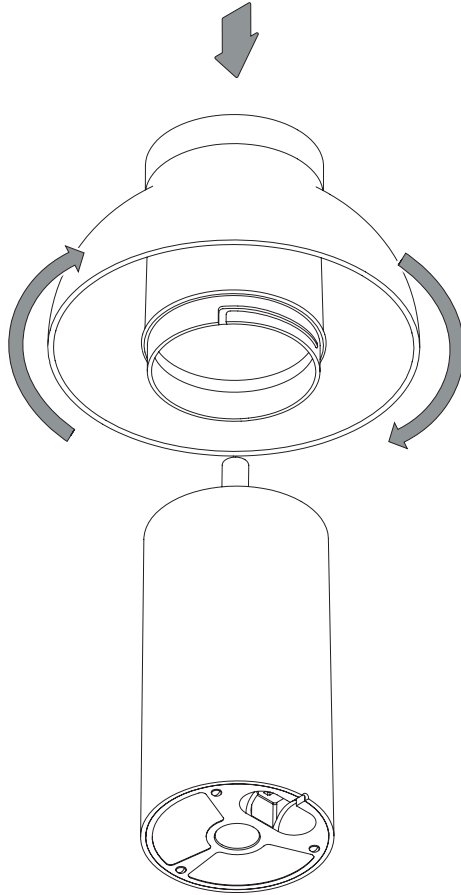

4.

To charge the battery, insert the USB charger into the USB port on the bottom of the lamp and connect the cable to a power supply. When the battery is charging, the light on the bottom will show red. When the battery is fully charged, the light will show green. The lamp can be used while charging, however this will extend the required charging time for full capacity.

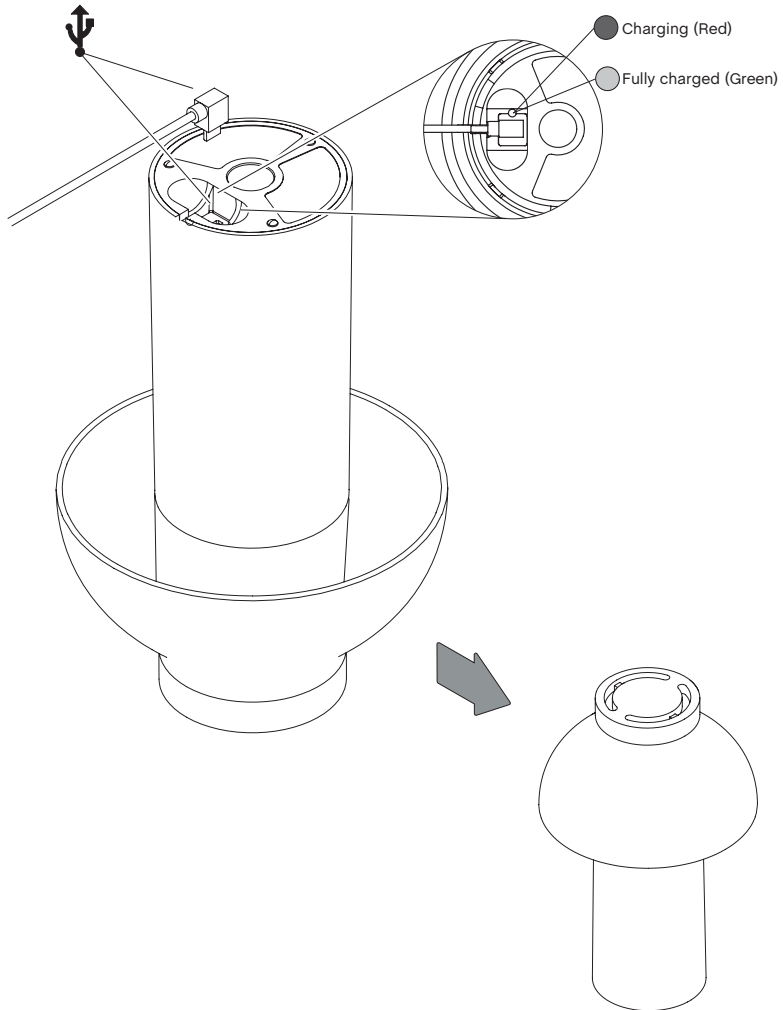

5.

To turn the lamp on, touch the round button on the bottom of the lamp. The lamp has a three-step dimmable feature. First push sets it to maximum brightness, second push to medium brightness and the third push to lowest brightness. Fourth push turns the lamp off.

Please save these instructions for future reference.

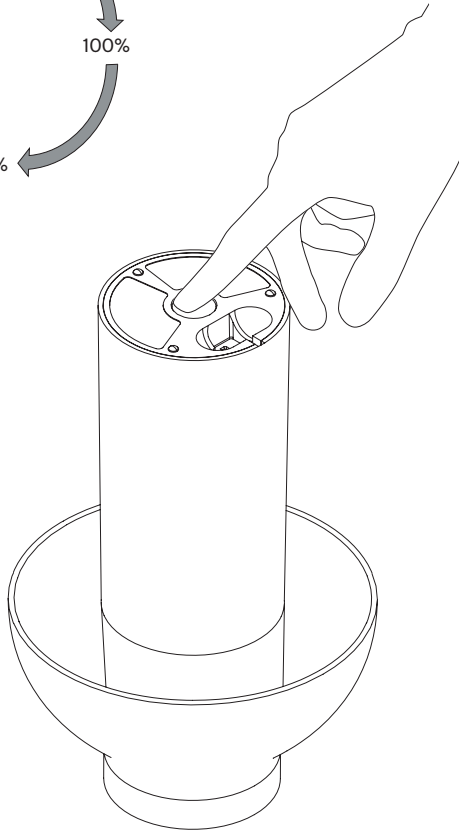
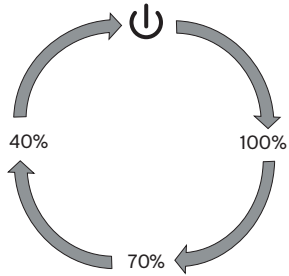

- CARE & MAINTENANCE -

Our Care & Maintenance offers guidance for optimal maintenance of your HAY product. It includes advice and instructions on cleaning and caring for specific materials to prolong the life of your lighting.



Please find our Care & Maintenance guide by scanning the QR code



You can find more relevant information on PC Portable by scanning the QR code

You can also find the same information here
hay.dk/downloads

Havnen 1 8700 Horsens Denmark
+45 4282 0282 / hay@hay.com

www.hay.com

04/01/2022

HAY