

Artemide®

Islet

design
M. Laakkonen

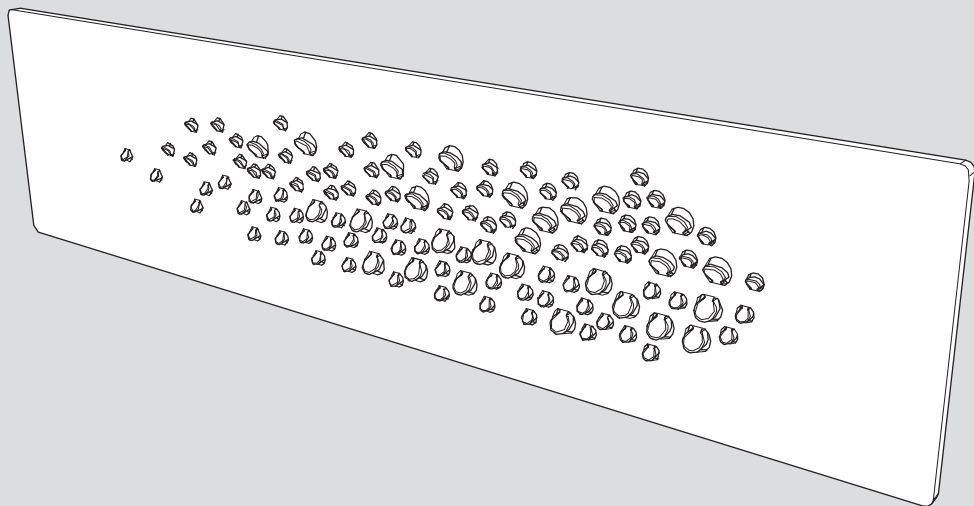



i

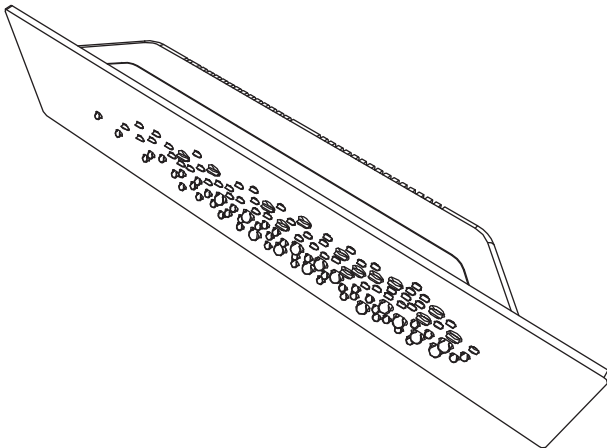
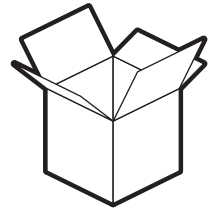
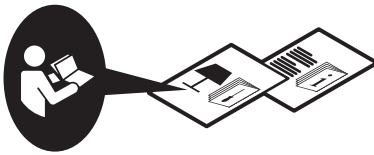
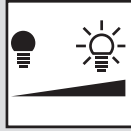

1

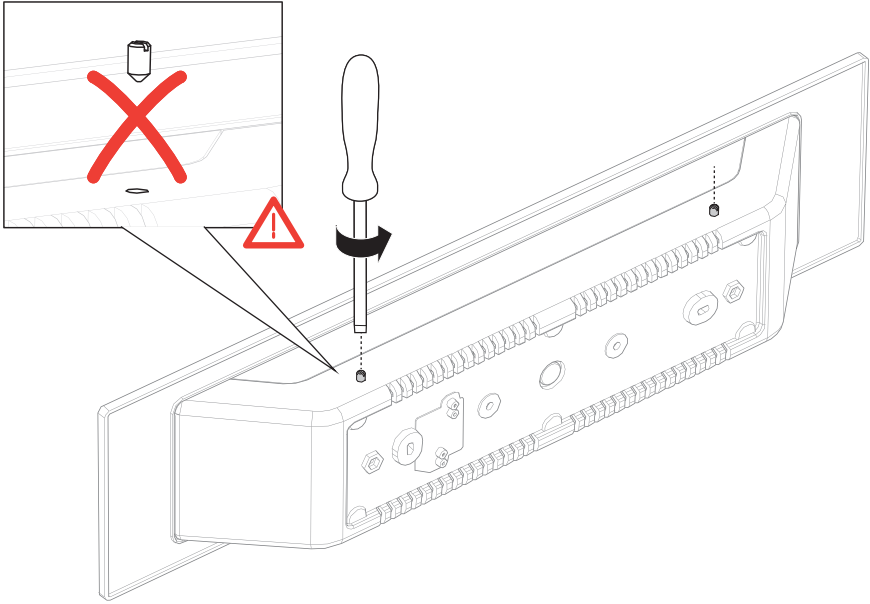

2

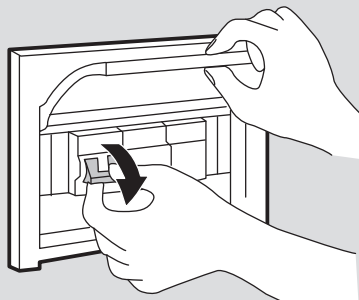
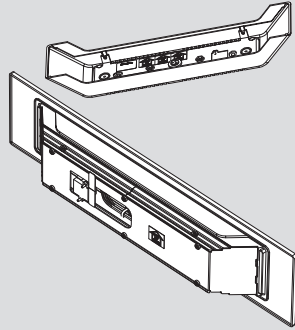
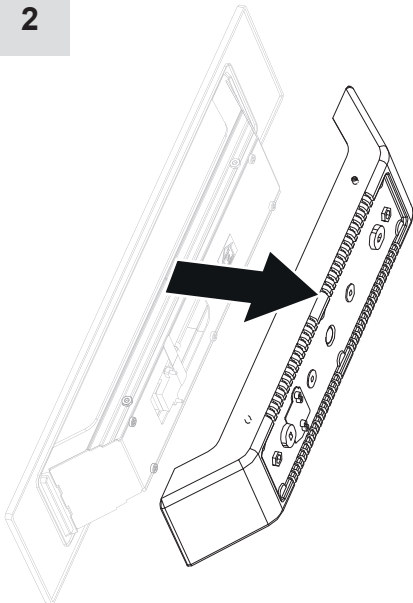

3

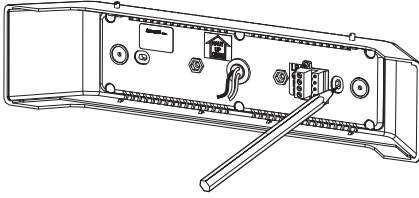

4

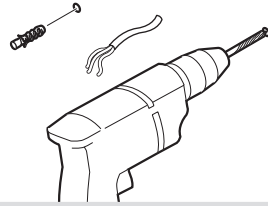

5

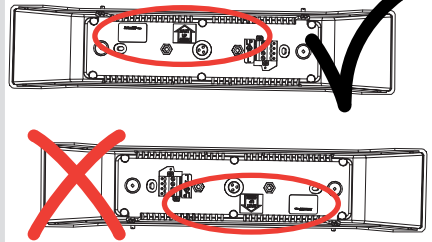
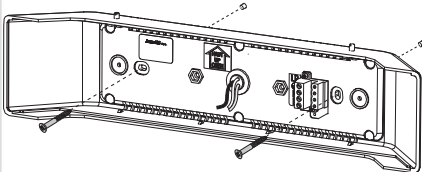

6a

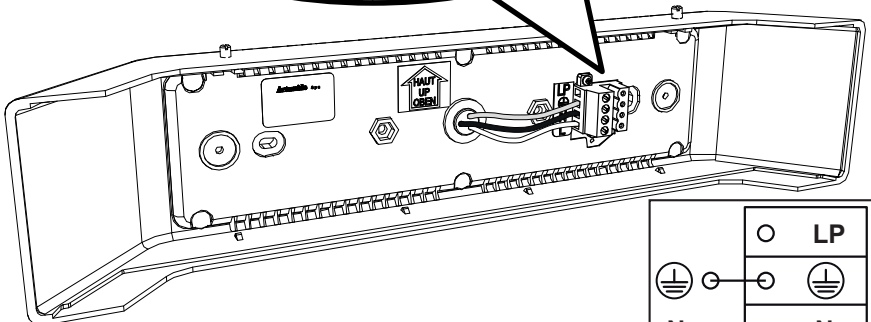
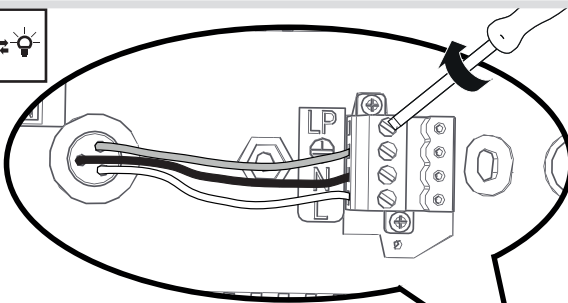

⊕	○	LP
⊕	○	⊕
N	○	N
L	○	L

6b

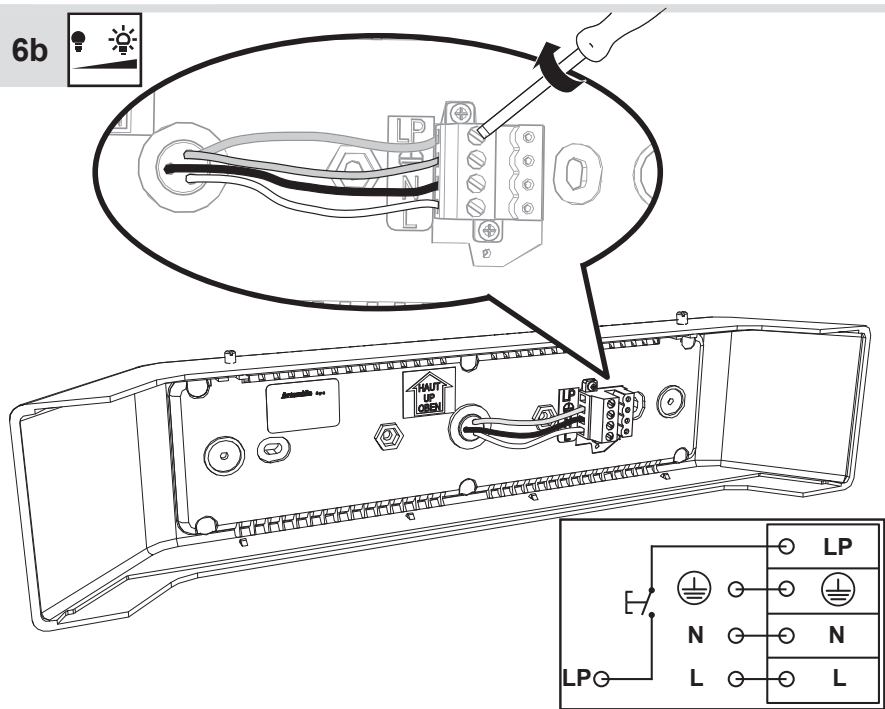

7

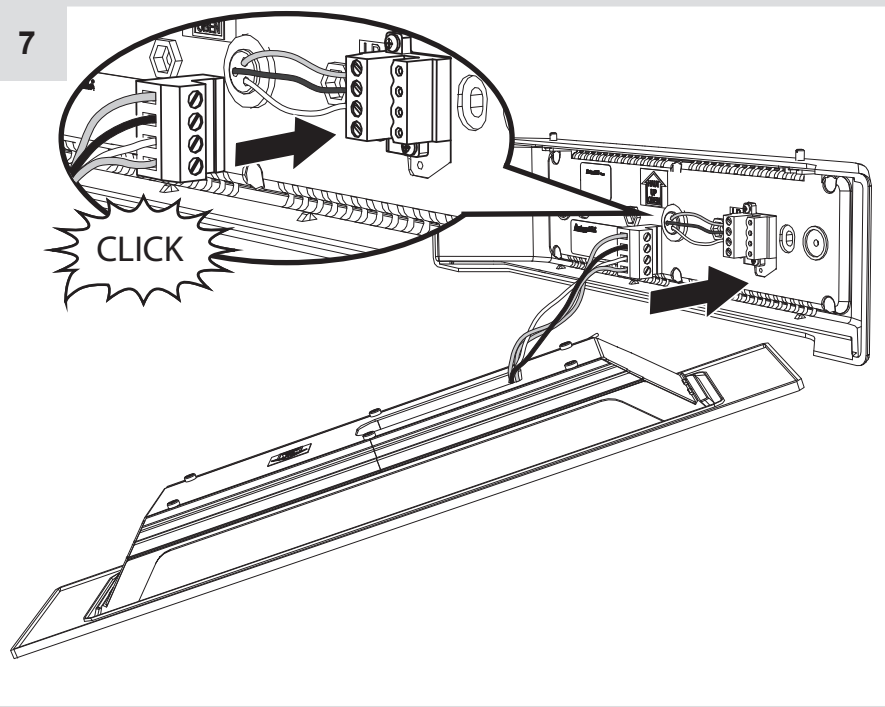

8

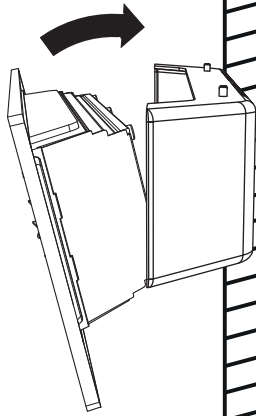

9

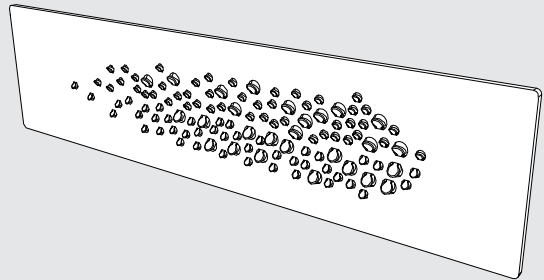
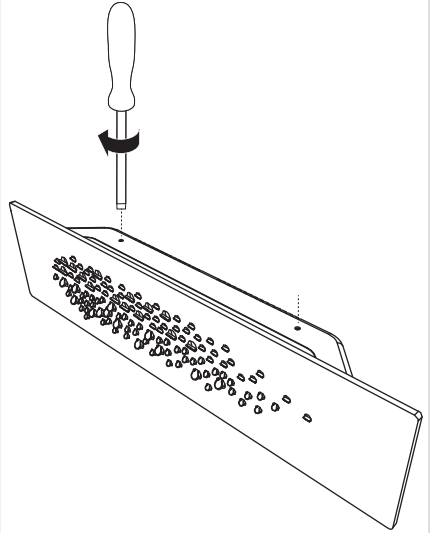

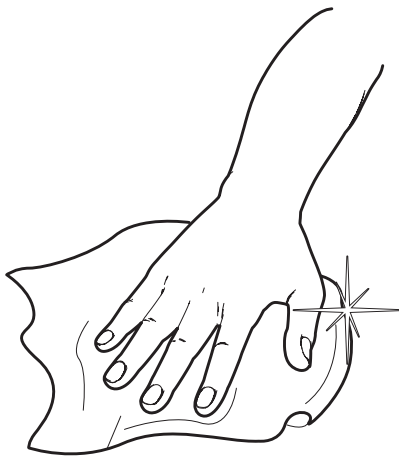

Artemide®



Artemide

via Bergamo, 18
20010 Pregnana M.se (MI)
ITALIA

tel. +39 02 935 181
fax +39 02 935 90 254
fax +39 02 935 90 496

www.artemide.com

VAT IT00846890150

cod. Y513000495A