



Paulmann

Safety Instructions

1, 2, 3, 4, 5, 6, 10, 11, 13, 19,
22, 23, 24, 25, 26, 33, 34



Info

www.paulmann.com

Paulmann Licht GmbH
Quezinger Feld 2
31832 Springe
Germany

www.paulmann.com

Art.-Nr.: 988.48

988.48

(+MA 326) PSU 05/17

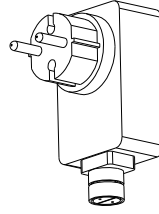

1x

A

Safety Instructions
Nr. 10,11,13

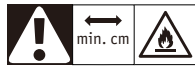

$\geq IP44$

$^{\circ}C$ Tc Ta

IP44

↑ TOP

Safety Instructions
Nr. 5

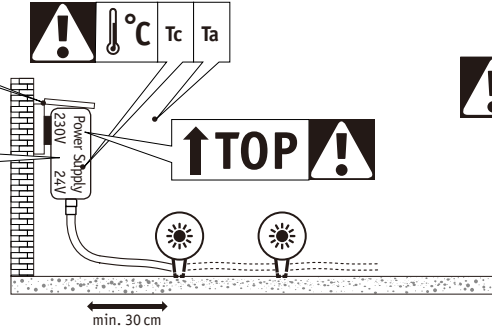

		24V-AC LED
		24V-DC LED

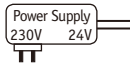

Nr. 11

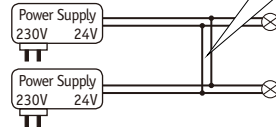

Power Supply 21W
Art.-Nr.: 988.48

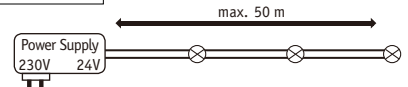

B1 B2

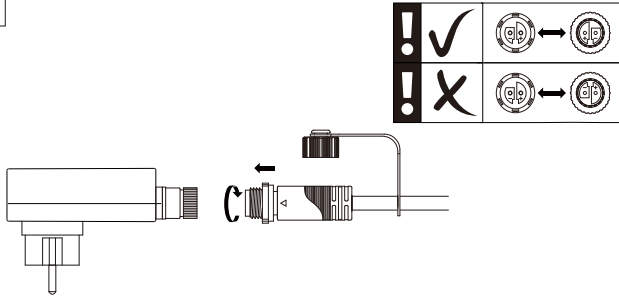

B1 B2

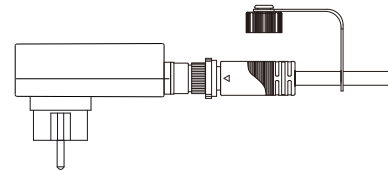

C1 C2 C3

Safety Instructions
Nr. 5

		< IP44
		$\geq IP44$

off

↑ TOP

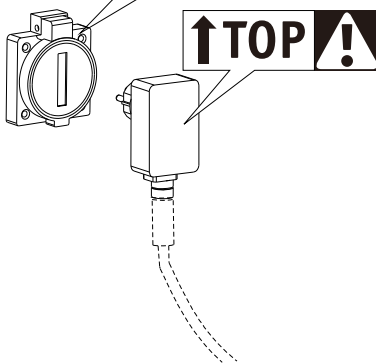

C1 C2 C3

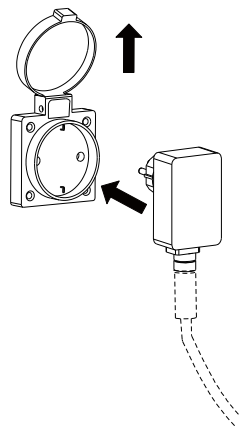

C1 C2 C3

