

## 10022139 / 10022142

39W LED / 80W Total  
incl. 6x LED Board: L9002891  
Motor: 40 Watt  
220-240V ~ 50Hz

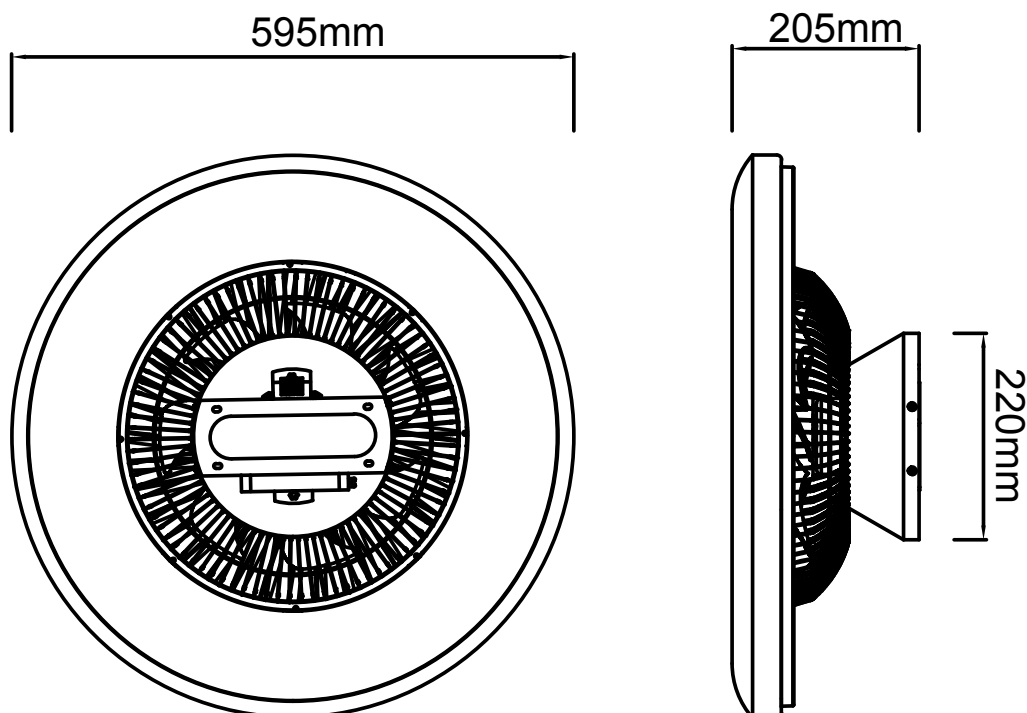

### (DE) Bestimmungsgemäße Verwendung

(EN) Intended use | (FR) Utilisation conforme | (NL) Beoogd gebruik | (PL) Stosowanie zgodnie z przeznaczeniem | (NO) Riktig bruk | (DK) Korrekt brug  
(SE) Avsedd användning | (FI) Määräystenmukainen käyttö | (IT) Impiego appropriato | (ES) Uso prescrito | (CZ) Použití v souladu s určením  
(PT) Utilização correta | (GR) Ενδεδειγμένη χρήση | (SK) Predpokladané použitie | (EE) Eeldatav kasutus | (LV) Paredzams lietojums  
(LT) Numatomas naudojimas | (RO) Utilizare intenționată | (SI) Predvidena uporaba | (HR) Namjenska upotreba | (HU) Tervezett felhasználás  
(BG) предназначена употреба | (AL) Përdorimi i parashikuar | (MK) Предвидена употреба | (TR) Amaçlı kullanım | (UK) Призначене використання  
(BA,ME,RS) Namjenska upotreba

(DE)	Ortsfeste Verwendung als Deckenventilator im Innenbereich	(GB)	Provided for stationary use as ceiling fan, indoors
(FR)	Prévu pour une utilisation stationnaire comme ventilateur de plafond, à l'intérieur	(NL)	Voorzien voor stationair gebruik als plafondventilator, binnenshuis
(PL)	Przeznaczony do użytku stacjonarnego jako wentylator sufitowy, wewnątrz pomieszczeń	(NO)	Leveres for stasjonær bruk som takvifte, innendørs
(DK)	Forudsat til stationær brug som loftsventilator, indendørs	(SE)	Avsedd för stationär användning som takfläkt, inomhus
(FI)	tarkoitettu käytettäväksi kiinteästi kattotuulettimena sisätiloissa	(IT)	Fornito per l'uso stazionario come ventilatore a soffitto, in ambienti interni
(ES)	Se suministra para uso estacionario como ventilador de techo, en interiores	(CZ)	Pro stacionární použití jako stropní ventilátor, v interiéru
(PT)	Fornecido para uso estacionário como ventilador de tecto, dentro de casa	(GR)	Προβλέπεται για σταθερή χρήση ως ανεμιστήρας οροφής, σε εσωτερικούς χώρους
(SK)	Pevné použitie ako stropný ventilátor v interiéri	(BG)	Стационарна употреба като таванен вентилатор за вътрешна употреба
(EE)	Stacionaarne kasutamise laeventilaatorina siseruumides	(LV)	Fiksēta lietošana kā griestu ventilators iekštelpās
(LT)	Fiksuotas naudojimas kaip lubų ventiliatorius patalpose	(RO)	Utilizare fixă ca ventilator de tavan în interior
(SI)	Fiksna uporaba kot stropni ventilator v notranjih prostorih	(HR)	Fiksna upotreba kao stropni ventilator u unutrašnjosti
(HU)	Helyhez kötött használat mennyezeti ventilátorként beltérben	(AL)	Përdorimi i palëvizshëm si ventilator tavan në ambiente të brendshme
(MK)	Фиксна употреба како тавански вентилатор во внатрешноста	(TR)	İç mekanda tavan vantilatörü olarak sabit kullanım
(UK)	Стационарне використання як стельовий вентилятор у приміщенні	(BA)	Fiksna upotreba kao stropni ventilator u unutrašnjosti
		(ME)	
		(RS)	

(DE) Lieferumfang		
(EN) Package contents   (FR) Contenu de la livraison   (NL) Bij de levering inbegrepen   (PL) Zakres dostawy   (NO) Levering   (DK) Leveringsomfang (SE) Leveransomfattning   (FI) Toimitussisältö   (IT) Fornitura   (ES) Volumen de suministro   (CZ) Rozsah dodávky   (PT) Material fornecido (GR) Παραδοτέος εξοπλισμός   (SK) Obsah balenia   (EE) Pakendi sisu   (LV) Pakas saturs   (LT) Pakuotės turinys (RO) Conținutul pachetului   (SI) Vsebina paketa   (HR) Sadržaj paketa   (HU) A csomag tartalma   (BG) обхват на доставката (AL) Përmbajtja e dorëzimit   (MK) Содржина на испорака   (TR) Teslimat içeriği   (UK) Зміст доставки   (BA,ME,RS) Sadržaj isporuke		
(DE) 1 Deckenventilator Montagematerial Montageanleitung	(GB) 1 ceiling fan Installation hardware Mounting instructions	(FR) 1 Ventilateur de plafond Matériel de montage Instructions de montage
(NL) 1 Plafondventilator Monteringsmateriale Montagehandleiding	(PL) 1 Wentylator sufitowy Elementy montażowe Instrukcja montażu	(NO) 1 Takviften Monteringsmateriale Brukerveiledning
(DK) 1 Loftventilator Monteringsmateriale Brugervejledning	(SE) 1 Takfläkt Monteringsmaterial Monteringsanvisning	(FI) 1 Kattotuuletin Asennusmateriaali Asennusohjeet
(IT) 1 Ventilatore da soffitto Materiale di montaggio Istruzioni di montaggio	(ES) 1 Ventilador de techo Material de montaje Instrucciones de montaje	(CZ) 1 Stropní ventilátor Materiál pro montáž Návod k montáži
(PT) 1 Ventilador de teto Material de montagem Instruções de montagem	(GR) 1 Ανεμιστήρας οροφής Υλικό συναρμολόγησης Οδηγίες συναρμολόγησης	(SK) 1 stropný ventilátor Inštalačný hardvér Inštalačná príručka
(BG) 1 таванен вентилатор материали за монтаж инструкции за монтаж	(EE) 1 laeventilaator Paigaldustarvikud Paigaldusjuhend	(LV) 1 griestu ventilators Instalācijas aparatūra Uzstādīšanas instrukcija
(LT) 1 lubų ventiliatorius Montavimo aparatinė įranga Montavimo instrukcija	(RO) 1 ventilator de tavan Hardware de instalare Instrucțiuni de montare	(SI) 1 stropni ventilator Namestitvena strojna oprema Navodila za montažo
(HR) 1 stropni ventilator Instalacijski hardver Upute za montažu	(HU) 1 mennyezeti ventilátor Telepítési hardver Szerelési útmutató	(AL) 1 ventilator tavani Materiali i montimit Udhëzuesi i montimit
(MK) 1 тавански вентилатор Монтажен материјал Упатство за монтажа	(TR) 1 tavan vantilatörü Montaj malzemesi Montaj kılavuzu	(UK) 1 стельовий вентилятор Монтажний матеріал Інструкція з монтажу
(BA) 1 stropni ventilator (ME) Montažni materijal (RS) Uputstvo za montažu		

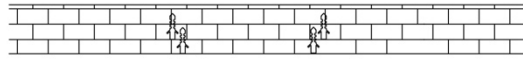
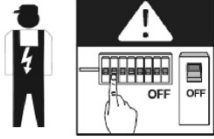

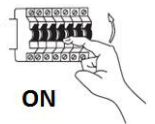
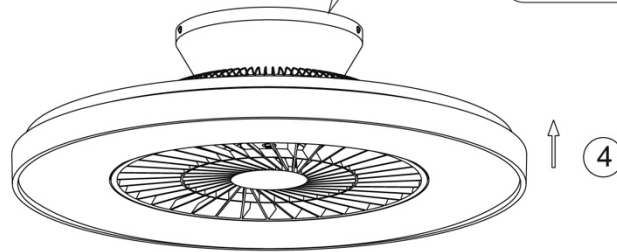
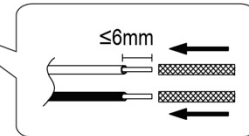
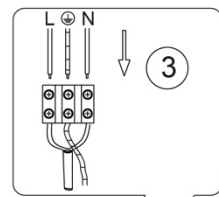
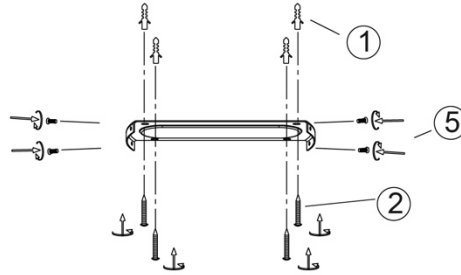

$\geq 4\text{mm}$

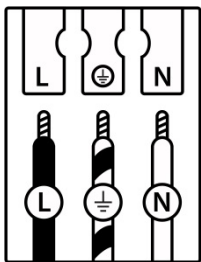

	(DE)	(EN)	(FR)	(NL)	(PL)	(NO)
<b>L</b>	Stromführender Leiter	Live conductor	Conducteur	Spanningvoerende draad	Przewód prądowy	Strømførende leder
	Schutzleiter	Earth conductor	Conducteur de protection (terre)	Aardkabel	Przewód uziemiający	Jordledningen
<b>N</b>	Neutralleiter	Neutral conductor	Conducteur neutre	Nulleider	Przewód zerowy	Nøytralleider

	(DK)	(SE)	(FI)	(IT)	(ES)	(CZ)
<b>L</b>	Strømførende leder	Strömförande ledare	Virtajohdin	Conduttore sotto tensione	Conductor de corriente	Vodič pod napětím
	Jordledningen	Skyddsledare	Suojajohdin	Conduttore di terra	Conductor de protección	Ochranný vodič
<b>N</b>	Neutralleider	Neutralledare	Nollajohdin	Conduttore neutro	Conductor neutro	Neutrální vodič



	(PT)	(GR)	(SK)	(EE)	(LV)	(LT)
<b>L</b>	Condutor vivo	Ρευματοφόρος αγωγός	Živý vodič	Faasisjuht	Dzīvais vadītājs	Gyvas dirigentas
	Condutor de terra	Αγωγός γείωσης	Zemný vodič	Maandusjuht	Zemes vadītājs	Žemės dirigentas
<b>N</b>	Condutor neutro	Ουδέτερος αγωγός	Neutrálny vodič	Neutraaljuht	Neitrālais vadītājs	Neutrinis dirigentas

	(RO)	(SI)	(HR)	(HU)	(BG)	(AL)
<b>L</b>	Conductor viu	Živi dirigent	Živi dirigent	Élő vezető	проводник под напряжение	Konduktor i gjallë
	Conductor de împământare	Zemeljski dirigent	Uzemljeni dirigent	Földvezető	защитен проводник	Dirigjent i tokës
<b>N</b>	Conductor neutru	Nevtralni dirigent	Neutralni dirigent	Semleges vezető	нулев проводник	Konduktor neutral

	(MK)	(TR)	(UK)	(BA)(ME)(RS)
<b>L</b>	Жив кондуктор	Canlı yönetici	Живий диригент	Živi dirigent
	Земјен проводник	Toprak iletkeni	Земельний провідник	Zemaljski provodnik
<b>N</b>	Неутрален проводник	Nötr iletken	Нейтральный провідник	Neutralni provodnik

## (DE) Verwendete Symbole

(EN) Safety Precautions | (FR) Symboles utilisés | (NL) Gebruikte symbolen | (PL) Stosowane symbole | (NO) Brukte symboler | (DK) Brugte symboler  
 (SE) Använda symboler | (FI) Käytetyt symbolit | (IT) Simboli usati | (ES) Símbolos empleados | (CZ) Použité symboly | (PT) Símbolos utilizados  
 (GR) Χρησιμοποιούμενα σύμβολα | (SK) Bezpečnostné opatrenia | (EE) Ohutusabinõud | (LV) Drošības pasākumi  
 (LT) Saugos priemonės | (RO) Măsuri de precauție | (SI) Varnostni ukrepi | (HR) Mjere opreza | (HU) Használt szimbólumok | (BG) Мерки за безопасност  
 (AL) Simbolet e përdorura | (MK) Користени симболи | (TR) Kullanılan semboller | (UK) Використовувані символи | (BA,ME,RS) Korišteni simboli

IP 20



# Lindby

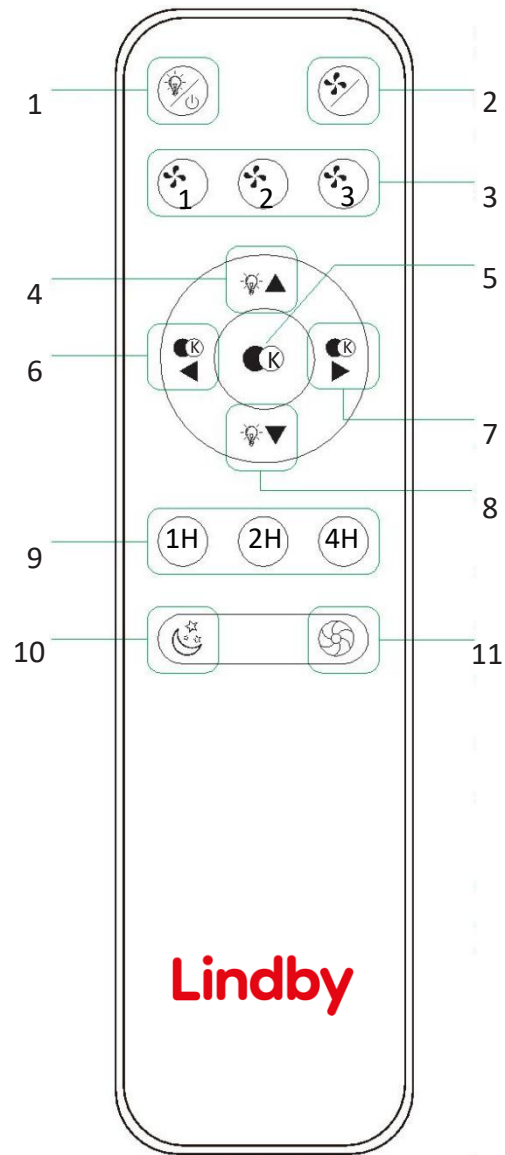

(DE)

Beschreibung der Funktionsweise des Lichts mit der Fernsteuerung:

1. Licht EIN/AUS.

Beim Einschalten des Lichts wird das zuletzt mit der Fernbedienung eingestellte Lichtszenario eingestellt (Memory-Funktion).

2. Lüfter aus.

3. Das Gerät verfügt über 3 verschiedene Leistungsstufen.

4. und 8. Helligkeitsregler: Die Verstellung erfolgt in Stufen. Durch kurzes Drücken können die einzelnen Stufen gesteuert werden, durch dauerhaftes Drücken der Taste wird die maximale oder minimale Helligkeit erreicht.

6. & 7. Lichtfarbe: Die Regelung erfolgt in Stufen. Die einzelnen Stufen können durch kurzes Drücken der Taste gesteuert werden. Die wärmste oder kälteste Farbeinstellung wird durch anhaltendes Drücken der Taste schneller erreicht.

5. Modus (Lichtfarbe):

1) Helligkeit 100% 3000K

2) Helligkeit 100% 4000K

3) Helligkeit 100% 6500K

9. Einstellung der Betriebszeit (mit H=Stunde) für den Ventilator, Timer ist 1H,2H4H

10. Nachtlicht

11. Keine Funktion.

(GB)

Description of how the light works with the remote-control unit:

1. Light ON/OFF.

When the light is switched on, the light scenario last set with the remote control is set (memory function).

2. Fan OFF.

3. The device has 3 different output levels.

4. & 8. Brightness regulator: The adjustment takes place in stages. By pressing for a short period, it is possible to control the individual stages. Pressing the button permanently results in the maximum or minimum brightness being reached.

6. & 7. Light color: The regulation takes place in stages. The individual levels can be controlled by briefly pressing the button. The warmest or coldest color setting is reached more quickly by pressing the key continuously.

5. Mode (light color):

1) Brightness 100% 3000K

2) Brightness 100% 4000K

3) Brightness 100% 6500K

9. Setting the operating time (with H=hour) for the fan, timer is 1H,2H4H

10. Night light

11. No function.

(FR)

Description du fonctionnement de la lampe avec la télécommande:

1. Lumière ON/OFF.

Lorsque la lumière est allumée, le dernier scénario lumineux réglé à l'aide de la télécommande est activé (fonction de mémoire).

2. Ventilateur éteint.

3. L'appareil dispose de 3 niveaux de sortie différents.

4. et 8. régulateur de luminosité: Le réglage se fait par étapes. En appuyant sur le bouton pendant une courte période, il est possible de contrôler les différentes étapes. En appuyant sur le bouton de façon permanente, la luminosité maximale ou minimale est atteinte.

6 & 7 Couleur de la lumière: La régulation s'effectue par étapes. Les différents niveaux peuvent être contrôlés en appuyant brièvement sur la touche. Le réglage de la couleur la plus chaude ou la plus froide est atteint plus rapidement en appuyant en continu sur la touche

5. Mode (couleur claire):

1) Luminosité 100% 3000K

2) Luminosité 100% 4000K

3) Luminosité 100% 6500K

9. Réglage de la durée de fonctionnement (avec H=heure) du ventilateur, minuterie 1H,2H4H

10. Veilleuse

11. Pas de fonction.

	QR	EAN
<p>(DE) Dieses Produkt enthält eine Lichtquelle der Energieeffizienzklasse F            (EN) This product contains a light source of energy efficiency class F            (FR) Ce produit comprend une source de lumière de classe d'efficacité énergétique F            (NL) Dit product bevat een lichtbron van energie-efficiëntieklasse F            (PL) Produkt ten zawiera źródło światła o klasie efektywności energetycznej F            (NO) Dette produktet inneholder en lyskilde i energieeffektivitetsklasse F            (DK) Dette produkt indeholder en lyskilde af energieeffektklasse F            (SE) Denna produkt innehåller en ljuskälla i energieffektivitetsklass F            (FI) Tämä tuote sisältää energiatehokkuusluokan F valonlähteen            (IT) Questo prodotto contiene una sorgente luminosa della classe di efficienza energetica F            (ES) Este producto contiene una fuente de luz de la clase de eficiencia energética F            (CZ) Tento výrobek obsahuje světelný zdroj třídy energetické účinnosti F            (PT) Este produto contém uma fonte de luz da classe de eficiência energética F            (GR) Αυτό το προϊόν περιέχει μια φωτεινή πηγή ενεργειακής απόδοσης κλάσης F            (SK) Tento výrobok obsahuje zdroj svetla triedy energetickej efektivity F            (EE) See toode sisaldab energiatõhususklassi F valgusallikat            (LV) Šis produkts satur enerģijas efektivitātes klases F gaismas avotu            (LT) Šis gaminys turi energijos efektyvumo klasės F šviesos šaltinį            (RO) Acest produs conține o sursă de lumină de clasă de eficiență energetică F            (SI) Ta izdelek vsebuje svetlobni vir energijskega razreda F            (HR) Ovaj proizvod sadrži izvor svjetlosti energetske učinkovitosti klase F            (HU) Ez a termék egy F energiahatékonysági osztályú fényforrást tartalmaz            (BG) Този продукт съдържа източник на светлина с клас на енергийна ефективност: F            (AL) Ky produkt përmban një burim drite të klasës së efikasitetit të energjisë F            (MK) Овој производ содржи извор на светлина од класа на енергетска ефикасност F            (TR) Bu ürün, enerji verimliliği sınıfı F olan bir ışık kaynağı içerir            (UK) Цей продукт містить джерело світла класу енергоефективності F            (BA)(ME)(RS) Ovaj proizvod sadrži izvor svjetlosti energetske klase F</p>		<p>4251911784336</p>

	<p>(DE) Durch einen Fachmann austauschbare Lichtquelle (nur LED).          (EN) Replaceable (LED only) light source by a professional.          (FR) Source de lumière remplaçable (LED uniquement) par un professionnel.          (NL) Lichtbron (alleen led) te vervangen door een professional.          (PL) Wymienne (tylko LED) źródło światła wykonane przez profesjonalistę.          (NO) Utskiftbar (kun LED) lyskilde av en profesjonell.          (DK) Udskiftelig lyskilde (kun LED), udskiftes af en elektriker.          (SE) Ljuskälla (endast LED) utbytbar genom fackman.          (FI) Ammattilainen voi vaihtaa vaihdettavan (vain LED) valonlähteen.          (IT) Sorgente luminosa (solo LED) sostituibile da un professionista.          (ES) Fuente de luz (solo LED) sustituable por un profesional.          (CZ) Vyměnitelný (pouze LED) světelný zdroj odborníkem.          (PT) Luz LED (apenas LED) substituível por um profissional.          (GR) Η πηγή φωτός (μόνο LED) να αντικαθίσταται από επαγγελματία.          (SK) Zdroj svetla (iba LED) vymeniteľný prostredníctvom odborníka.          (EE) Spetsialisti poolt vahetatav valgusallikas (ainult LED).          (LV) Speciālista maināms gaismas avots (tikai LED).          (LT) Specialisto keičiamas šviesos šaltinis (tik LED).          (RO) Sursă de lumină schimbabilă de către un specialist (doar LED).          (SI) Svetlobni vir, ki ga lahko zamenja strokovnjak (samo LED).          (HR) Izvor svjetlosti koji može zamijeniti stručnjak (samo LED).          (HU) Szakember által cserélhető (csak LED) fényforrás.          (BG) Светлинен източник, който може да се смени от специалист (само LED).          (AL) Burim drite i zëvendësueshëm (LED vetëm) nga një profesionist.          (MK) Изворот на светлина (само LED) се заменува од професионалец.          (TR) Değiştirilebilir (yalnızca LED) ışık kaynağı bir profesyonel tarafından değiştirilir.          (UK) Замінний (тільки LED) джерело світла замінюється фахівцем.          (BA)(ME)(RS) Zamjenjiv (samo LED) izvor svjetlosti zamjenjuje profesionalac.</p>
--	--

	<p>(DE) Durch einen Fachmann austauschbares Betriebsgerät.          (EN) Replaceable control gear by a professional.          (FR) Contrôleur remplaçable par un professionnel.          (NL) Voorschakelapparatuur te vervangen door een professional.          (PL) Wymienny układ sterujący przez profesjonalistę.          (NO) Utskiftbar kontrollutstyr av en profesjonell.          (DK) Udskiftelig igangsætter, udskiftes af en elektriker.          (SE) Styrdon utbytbar genom fackman.          (FI) Ammattilainen voi vaihtaa vaihdettavat ohjauslaitteet.          (IT) Dispositivo di controllo sostituibile da un professionista.          (ES) Dispositivo de control sustituable por un profesional.          (CZ) Vyměnitelný předřadník odborníkem.          (PT) Dispositivo de controlo substituível por um profissional.          (GR) Ο εξοπλισμός ελέγχου να αντικαθίσταται από επαγγελματία.          (SK) Predradník vymeniteľný prostredníctvom odborníka.          (EE) Spetsialisti poolt vahetatav juhtseade.          (LV) Speciālista maināma vadības iekārta.          (LT) Specialisto keičiamas valdymo įrenginys.          (RO) Aparat de comandă schimbabil de către un specialist.          (SI) Nadomestna krmilna naprava, ki jo lahko zamenja strokovnjak.          (HR) Zamjenjivi upravljački sklop koji može zamijeniti stručnjak.          (HU) Szakember által cserélhető vezérlőszerkezet.          (BG) Уред, който може да се смени от специалист.          (AL) Pajisje kontrolli e zëvendësueshme nga një profesionist.          (MK) Заменлива контролна опрема од страна на професионалец.          (TR) Profesyonel tarafından değiştirilebilir kontrol donanımı.          (UK) Замінний контрольний пристрій фахівцем.          (BA)(ME)(RS) Zamjenjiva kontrolna oprema od strane profesionalca.</p>
--	---