

9956031

33W LED / 36W Total
incl. LED Board: L9001011
230V ~ 50Hz



(DE) Bestimmungsgemäße Verwendung

(GB) Intended use / (FR) Utilisation conforme / (NL) Beoogd gebruik / (PL) Stosowanie zgodnie z przeznaczeniem / (NO) Riktig bruk / (DK) Korrekt brug / (SE) Avsedd användning / (FI) Määräystenmukainen käyttö

(IT) Impiego appropriato / (ES) Uso prescrito / (CZ) Použití v souladu s určením / (PT) Utilização correta / (GR) Ενδεδειγμένη χρήση

| | | | |
|------|--|------|---|
| (DE) | Ortsfeste Verwendung als Deckenleuchte im Innenbereich | (GB) | Provided for stationary indoor use on ceilings |
| (FR) | Installation fixe en tant que plafonnier à l'intérieur | (NL) | Vast gebruik als plafondlamp binnenshuis |
| (PL) | Do montażu stacjonarnego jako lampa sufitowa do wnętrz | (NO) | Til stasjonært bruk som taklampe innendørs |
| (DK) | Til stationær brug som loftlampe indendørs | (SE) | Används som fast taklampe inomhus |
| (FI) | Kiinteä käyttö sisätilojen kattovalaisimena | (IT) | Impiego fisso come plafoniera in ambienti interni |
| (ES) | Empleo fijo como lámpara de techo en interiores | (CZ) | Stacionární použití jako stropní svítidlo v interiéru |
| (PT) | Aplicação fixa como luminária de teto em interiores | (GR) | Σταθερή χρήση ως φωτιστικό οροφής σε εσωτερικό χώρο |

(DE) Verwendete Symbole

(GB) Safety Precautions / (FR) Symboles utilisés / (NL) Gebruikte symbolen / (PL) Stosowane symbole / (NO) Brukte symboler / (DK) Brugte symboler / (SE) Använda symboler / (FI) Käytetyt symbolit / (IT) Simboli usati / (ES) Símbolos empleados / (CZ) Použité symboly / (PT) Símbolos utilizados / (GR) Χρησιμοποιούμενα σύμβολα

IP 20



(DE) Lieferumfang

(GB) Package contents / (FR) Contenu de la livraison / (NL) Bij de levering inbegrepen / (PL) Zakres dostawy / (NO) Leveringsomfang / (DK) Leveringsomfang / (SE) Leveransomfattning / (FI) Toimitussisältö / (IT) Fornitura / (ES) Volumen de suministro / (CZ) Rozsah dodávky / (PT) Material fornecido / (GR) Παραδοτέος εξοπλισμός

| | | | | | |
|------|---|------|---|------|--|
| (DE) | 1 Deckenleuchte Montagematerial Montageanleitung | (GB) | 1 Ceiling lamp Installation hardware Mounting instructions | (FR) | 1 Plafonnier Matériel de montage Instructions de montage |
| (NL) | 1 Plafondlamp Monteringsmateriale Montagehandleiding | (PL) | 1 Lampa sufitowa Elementy montażowe Instrukcja montażu | (NO) | 1 Taklampe Monteringsmateriale Brukerveiledning |
| (DK) | 1 Loftlampe Monteringsmateriale Brugervejledning | (SE) | 1 Taklampe Monteringsmaterial Monteringsanvisning | (FI) | 1 Kattovalaisin Asennusmateriaali Asennusohjeet |
| (IT) | 1 Plafoniera Materiale di montaggio Istruzioni di montaggio | (ES) | 1 Lámpara de techo Material de montaje Instrucciones de montaje | (CZ) | 1 Stropní svítidlo Materiál pro montáž Návod k montáži |
| (PT) | 1 Luminária de teto Material de montagem Instruções de montagem | (GR) | 1 Φωτιστικό οροφής Υλικό συναρμολόγησης Οδηγίες συναρμολόγησης | | |

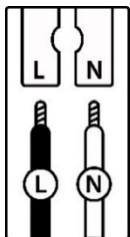
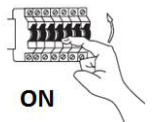
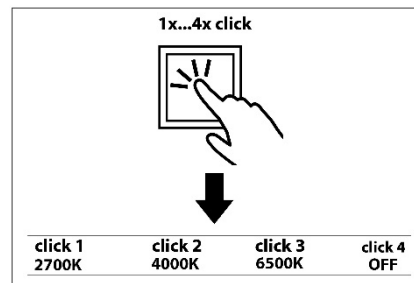
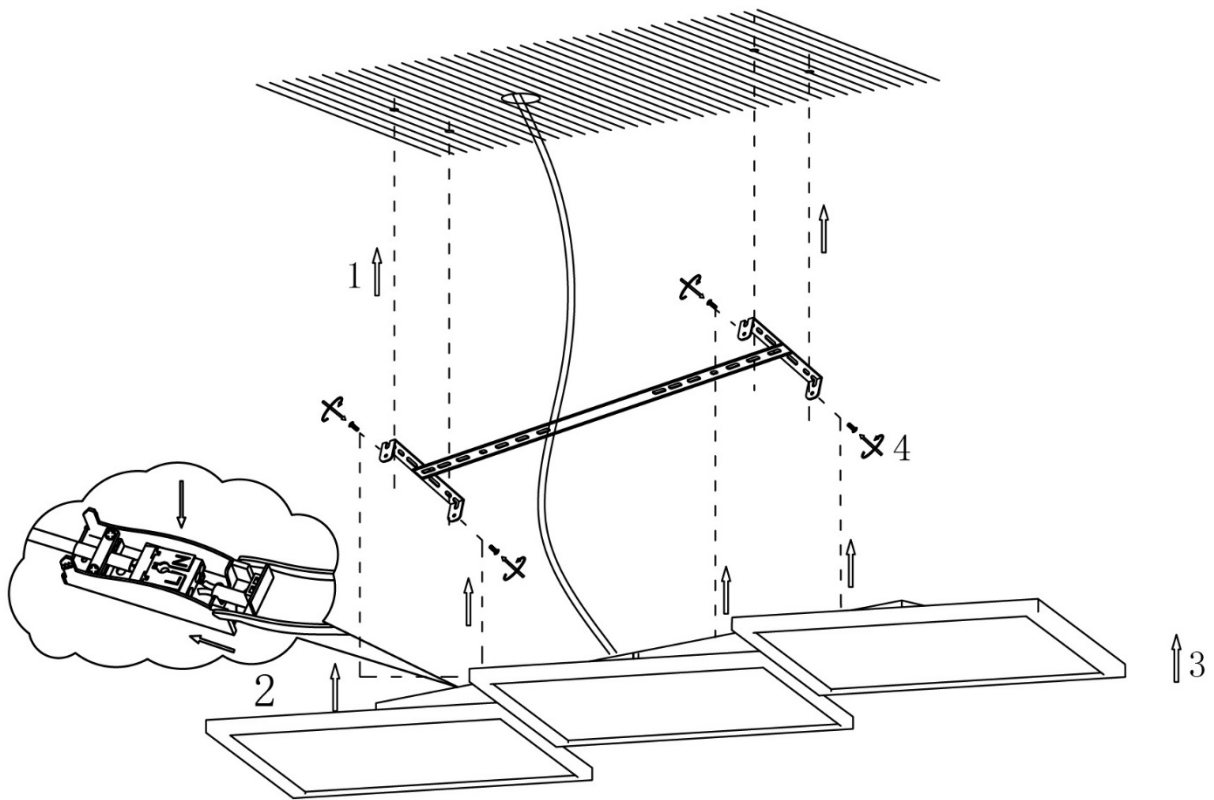
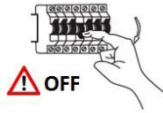

| | (DE) | (GB) | (FR) | (NL) | (PL) | (NO) | (DK) |
|----------|-----------------------|-------------------|-------------------|------------------------|-----------------|--------------------|--------------------|
| L | Stromführender Leiter | Live conductor | Conducteur | Spanningvoerende draad | Przewód prądowy | Strømførende leder | Strømførende leder |
| N | Neutralleiter | Neutral conductor | Conducteur neutre | Nulleider | Przewód zerowy | Nøytralleder | Neutralleider |

| | (SE) | (FI) | (IT) | (ES) | (CZ) | (PT) | (GR) |
|----------|---------------------|-------------|---------------------------|---------------------------------|-------------------|-----------------|---------------------|
| L | Strömförande ledare | Virtajohdin | Conduttore sotto tensione | Líneas conductoras de corriente | Vodič pod napětím | Condutor vivo | Ρευματοφόρος αγωγός |
| N | Neutralledare | Nollajohdin | Conduttore neutro | Conductor neutro | Neutrální vodič | Condutor neutro | Ουδέτερος αγωγός |

| | QR | EAN |
|--|---|----------------------|
| <p>(DE) Dieses Produkt enthält eine Lichtquelle der Energieeffizienzklasse E (EN) This product contains a light source of energy efficiency class E (FR) Ce produit comprend une source de lumière de classe d'efficacité énergétique E (NL) Dit product bevat een lichtbron van energie-efficiëntieklasse E (PL) Produkt ten zawiera źródło światła o klasie efektywności energetycznej E (NO) Dette produktet inneholder en lyskilde i energieeffektivitetsklasse E (DK) Dette produkt indeholder en lyskilde af energieeffektklasse E (SE) Denna produkt innehåller en ljuskälla i energieffektivitetsklass E (FI) Tämä tuote sisältää energiatehokkuusluokan E valonlähteen (IT) Questo prodotto contiene una sorgente luminosa della classe di efficienza energetica E (ES) Este producto contiene una fuente de luz de la clase de eficiencia energética E (CZ) Tento výrobek obsahuje světelný zdroj třídy energetické účinnosti E (PT) Este produto contém uma fonte de luz da classe de eficiência energética E (GR) Αυτό το προϊόν περιέχει μια φωτεινή πηγή ενεργειακής απόδοσης κλάσης E (SK) Tento výrobok obsahuje zdroj svetla triedy energetickej efektivity E</p> |  | <p>4251911714401</p> |

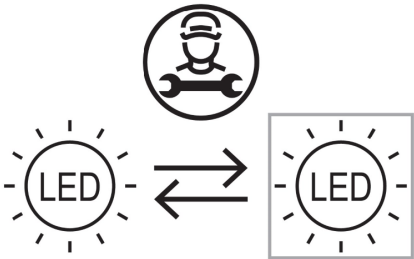
| | |
|--|--|
|  | <p>(DE) Durch einen Fachmann austauschbare Lichtquelle (nur LED). (EN) Replaceable (LED only) light source by a professional. (FR) Source de lumière remplaçable (LED uniquement) par un professionnel. (NL) Lichtbron (alleen led) te vervangen door een professional. (PL) Wymienne (tylko LED) źródło światła wykonane przez profesjonalistę. (NO) Utskiftbar (kun LED) lyskilde av en profesjonell. (DK) Udskiftelig lyskilde (kun LED), udskiftes af en elektriker. (SE) Ljuskälla (endast LED) utbytbar genom fackman. (FI) Ammattilainen voi vaihtaa vaihdettavan (vain LED) valonlähteen. (IT) Sorgente luminosa (solo LED) sostituibile da un professionista. (ES) Fuente de luz (solo LED) sustituible por un profesional. (CZ) Vyměnitelný (pouze LED) světelný zdroj odborníkem. (PT) Luz LED (apenas LED) substituível por um profissional. (GR) Η πηγή φωτός (μόνο LED) να αντικαθίσταται από επαγγελματία. (SK) Zdroj svetla (iba LED) vymeniteľný prostredníctvom odborníka.</p> |
|--|--|

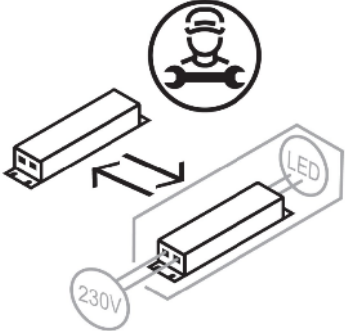
| | |
|---|--|
|  | <p>(DE) Durch einen Fachmann austauschbares Betriebsgerät. (EN) Replaceable control gear by a professional. (FR) Contrôleur remplaçable par un professionnel. (NL) Voorschakelapparatuur te vervangen door een professional. (PL) Wymienny układ sterujący przez profesjonalistę. (NO) Utskiftbar kontrollutstyr av en profesjonell. (DK) Udskiftelig igangsætter, udskiftes af en elektriker. (SE) Styrdon utbytbar genom fackman. (FI) Ammattilainen voi vaihtaa vaihdettavat ohjauslaitteet. (IT) Dispositivo di controllo sostituibile da un professionista. (ES) Dispositivo de control sustituible por un profesional. (CZ) Vyměnitelný předřadník odborníkem. (PT) Dispositivo de controlo substituível por um profissional. (GR) Ο εξοπλισμός ελέγχου να αντικαθίσταται από επαγγελματία. (SK) Predradník vymeniteľný prostredníctvom odborníka.</p> |
|---|--|