

A04 FLIA

design Alessandro Zambelli

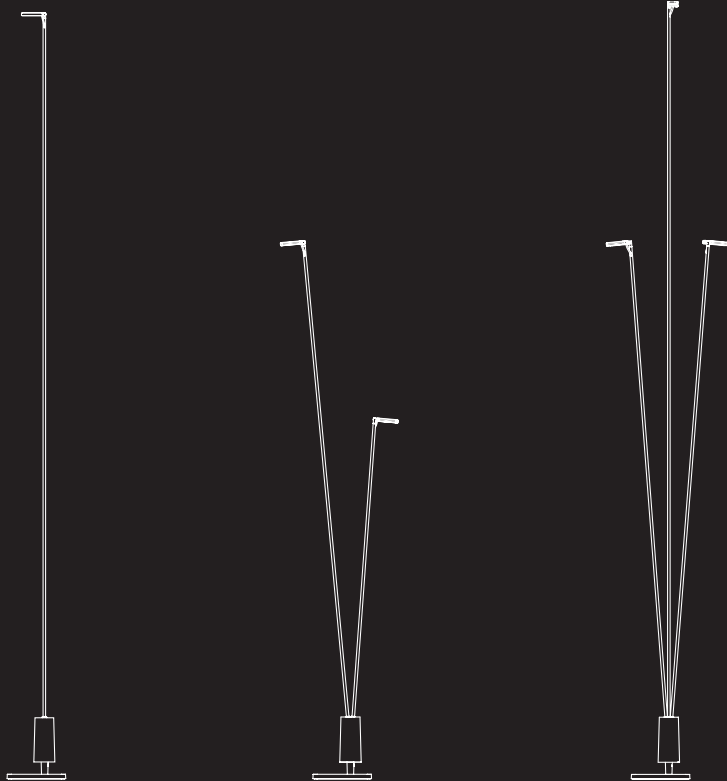

**LUCE
PLAN**

A04TF



A04TF

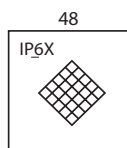
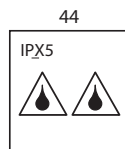
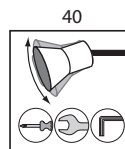
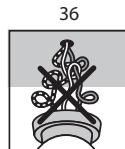
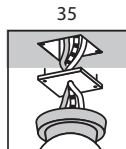
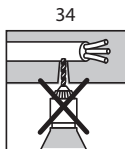
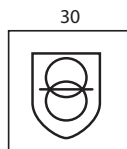
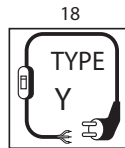
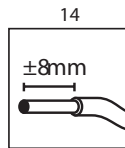
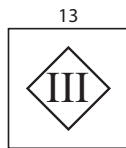
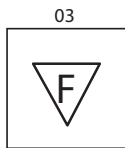
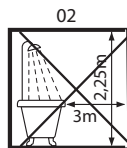

A04TF1A

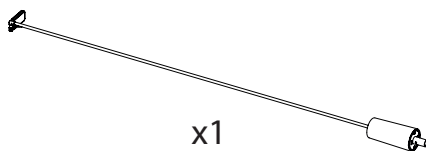
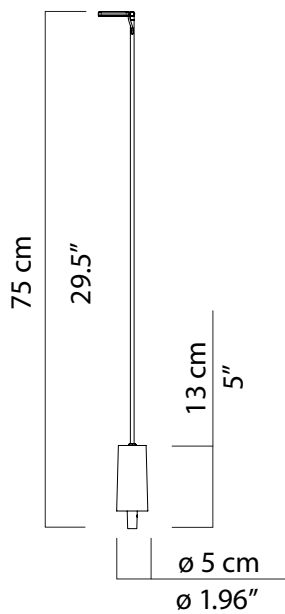

kg 0,5 kg

lb 1,1 lb

A04TF1B

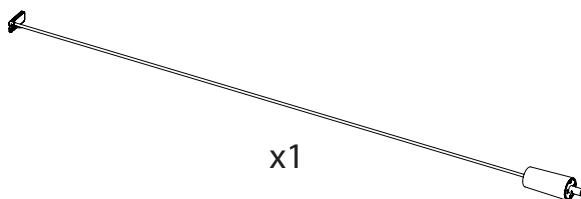
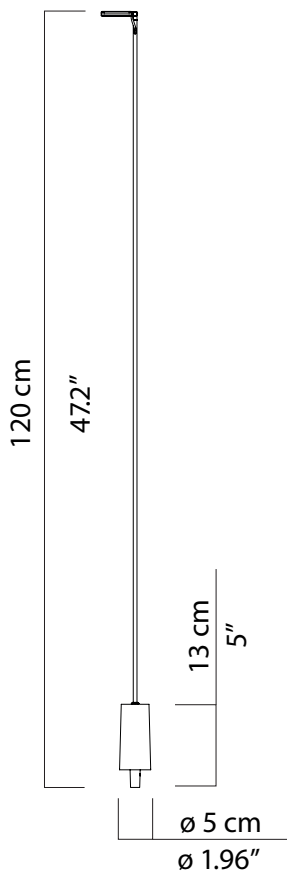

kg 0,5 kg

lb 1,1 lb

A04TF1C

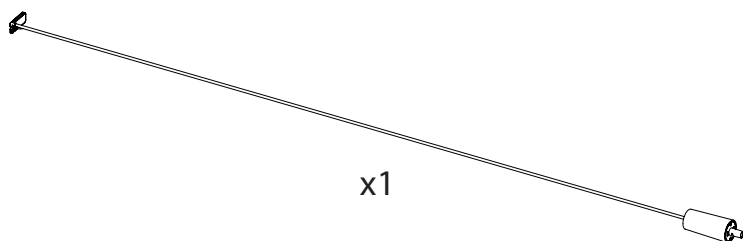
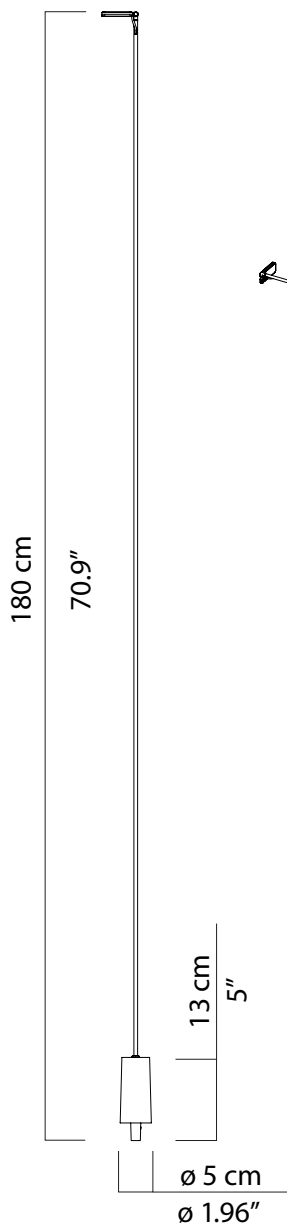

kg 0,5 kg

lb 1,1 lb

A04TF2

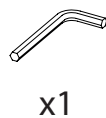
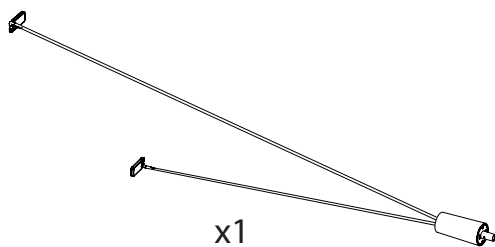
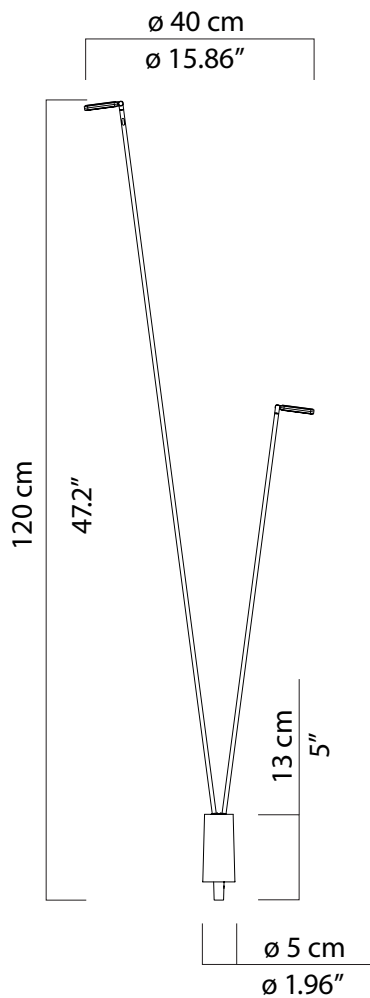

kg 0,6 kg

lb 1,3 lb

A04TF3



a



b

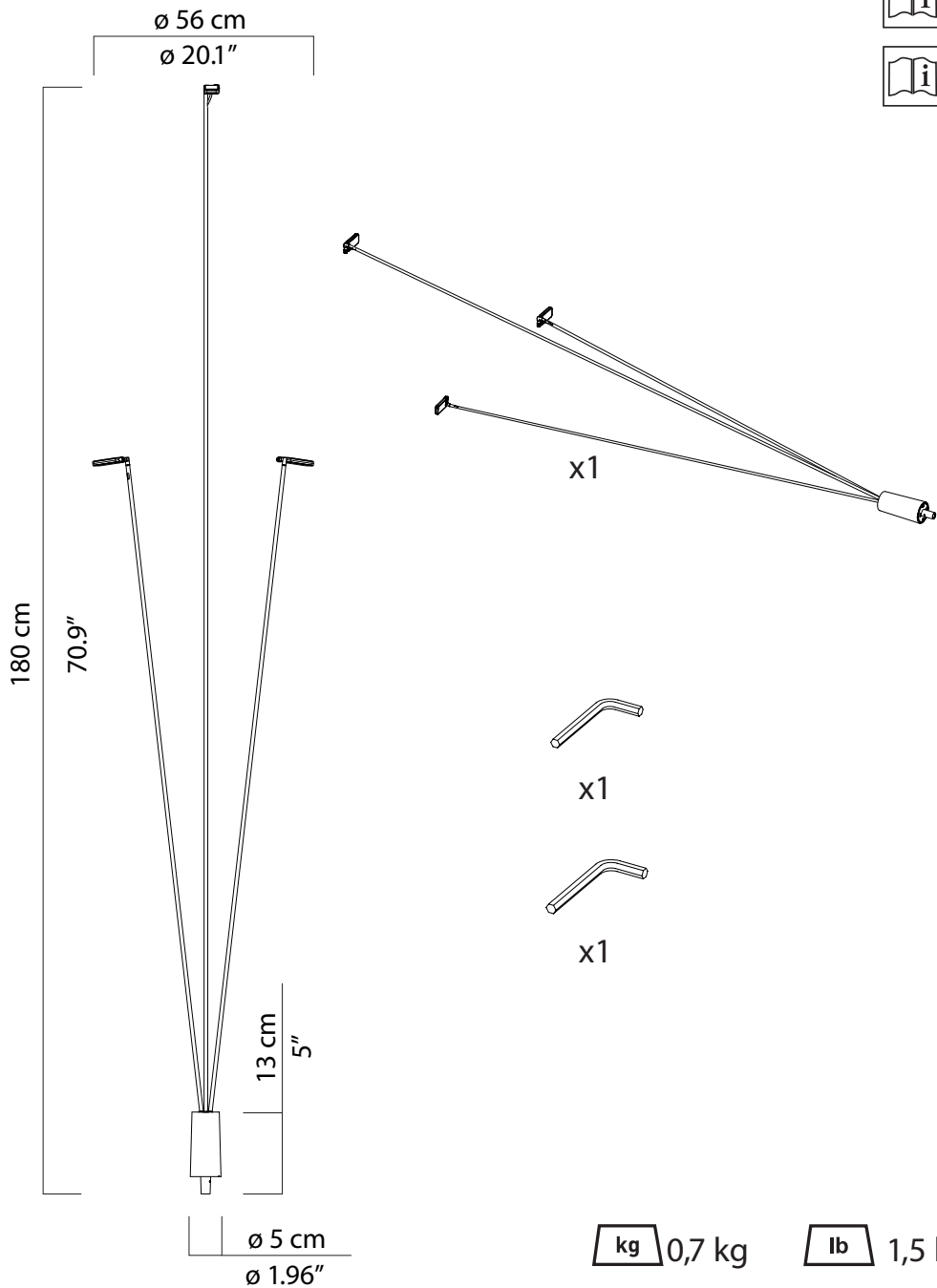

A04/1

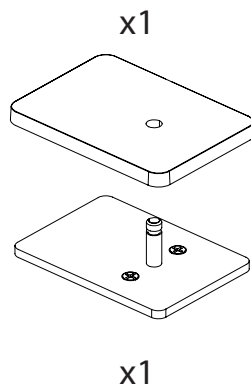
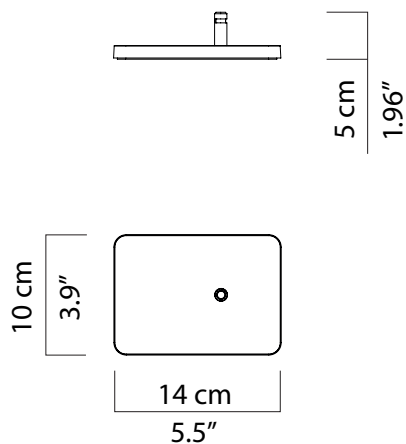

kg 0,6 kg

lb 1,3 lb

A04/2

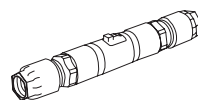
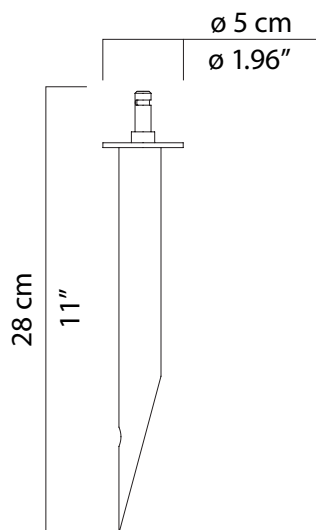

x1

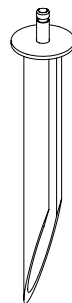

x1

kg 0,4 kg

lb 0,9 lb



A04TF1A
A04TF1B
A04TF1C



A04TF2

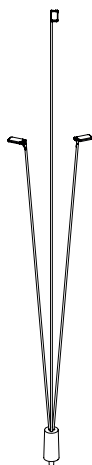

A04TF3



A04/1

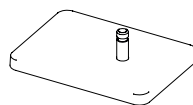

A04/2

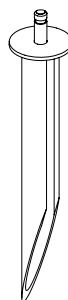

1

1.1 A04/1 - A04/2

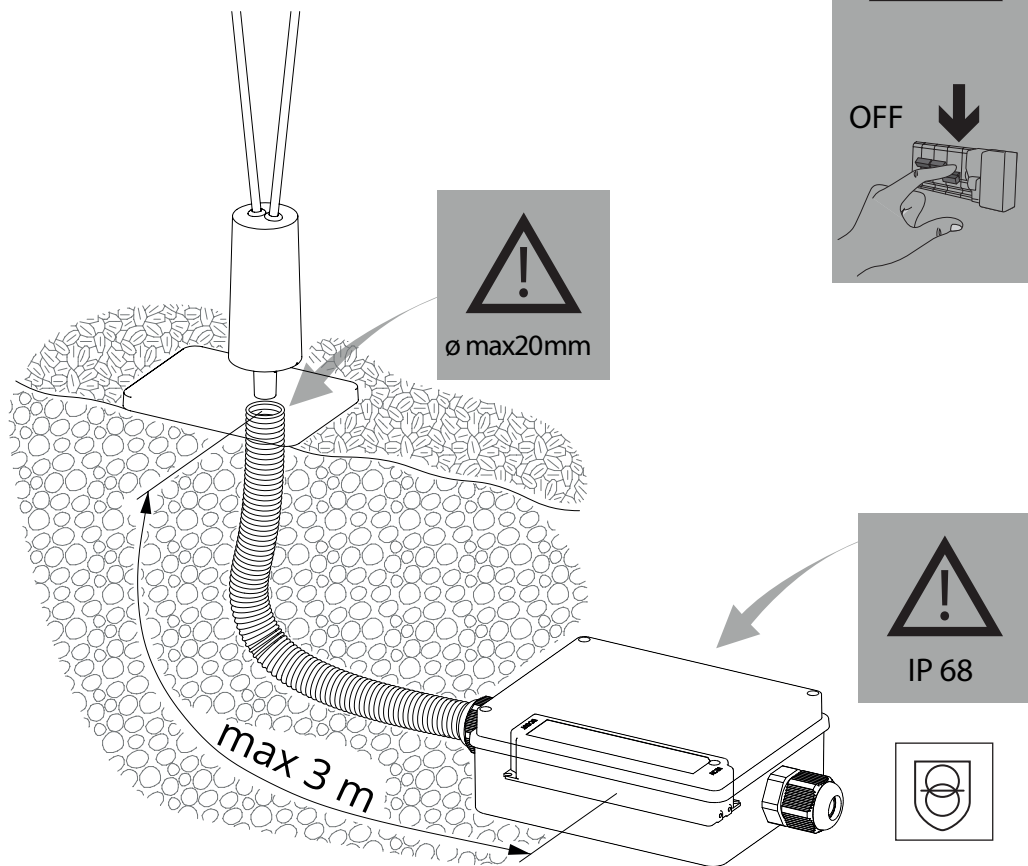

ON-OFF DRIVER	PUSH-DIM DALI DRIVER		OTHER LED DRIVER SETTINGS
A04/03	A04/04	A04TF1A	300mA (8V) min.3W
		A04TF1B	
		A04TF1C	
		A04TF2	600mA (8V) min.5W
		A04TF3	900mA (8V) min.8W

1.2 A04/1

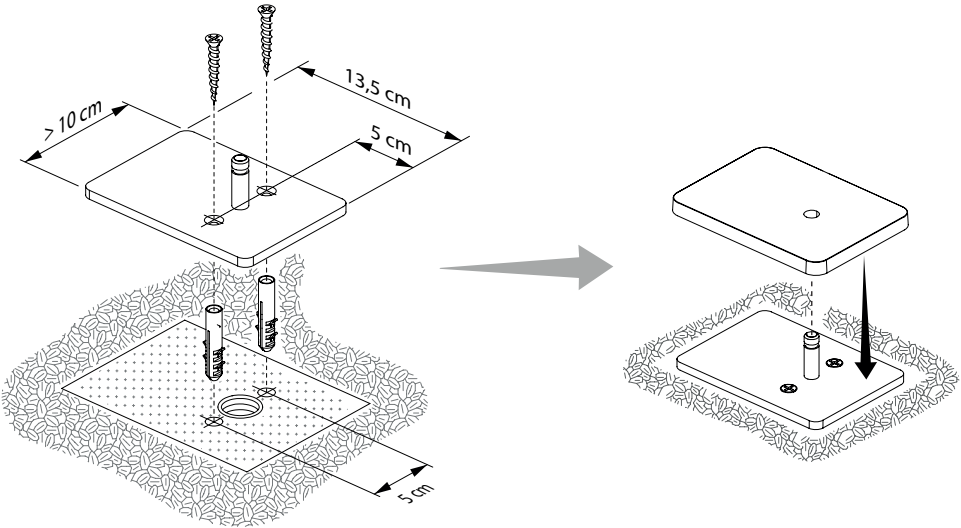
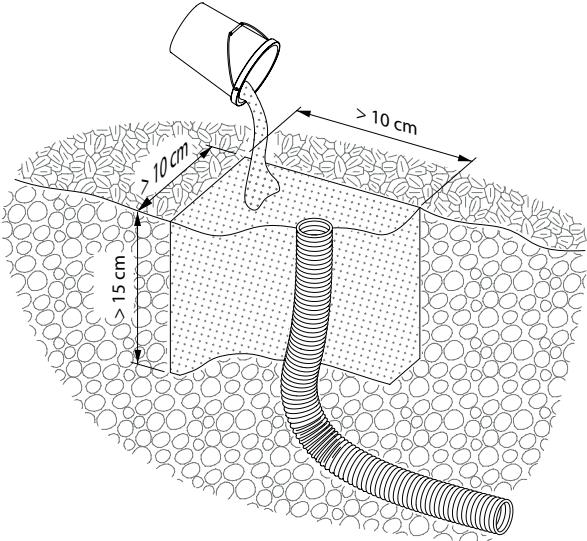

1.2 A04/2

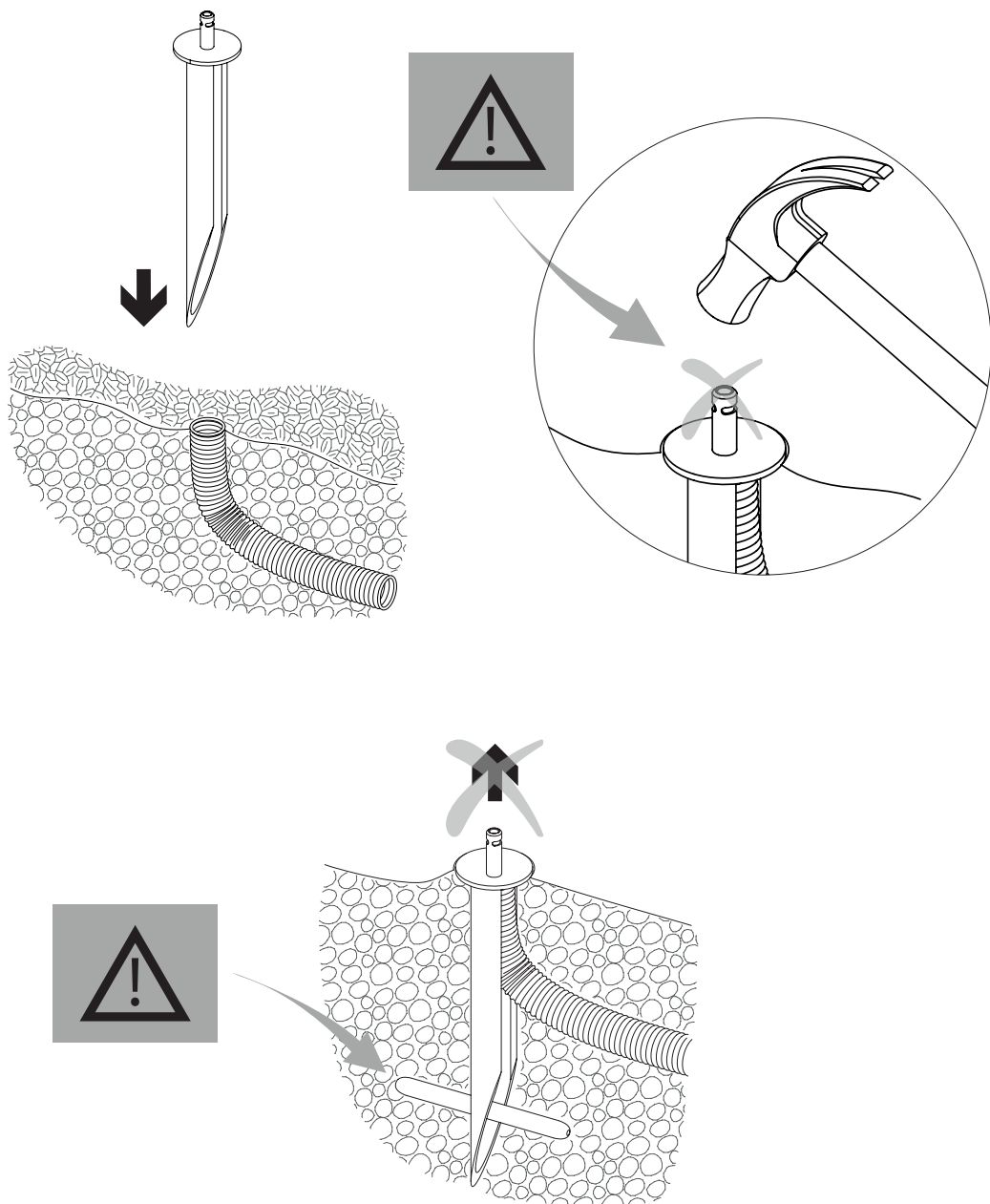

1.3

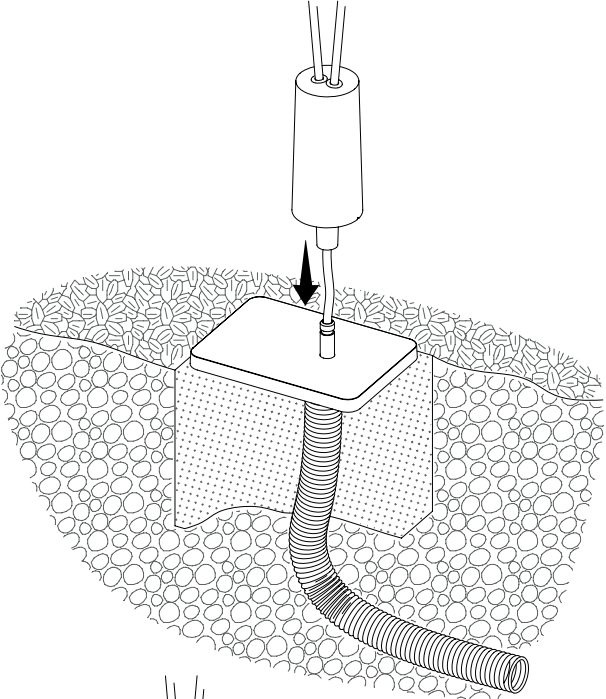

A04/1

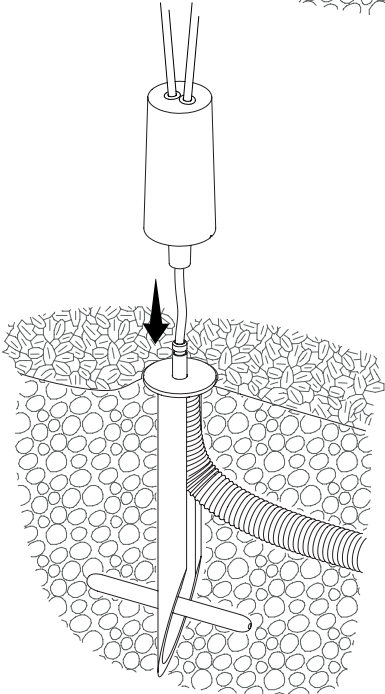

A04/2

2

2.1

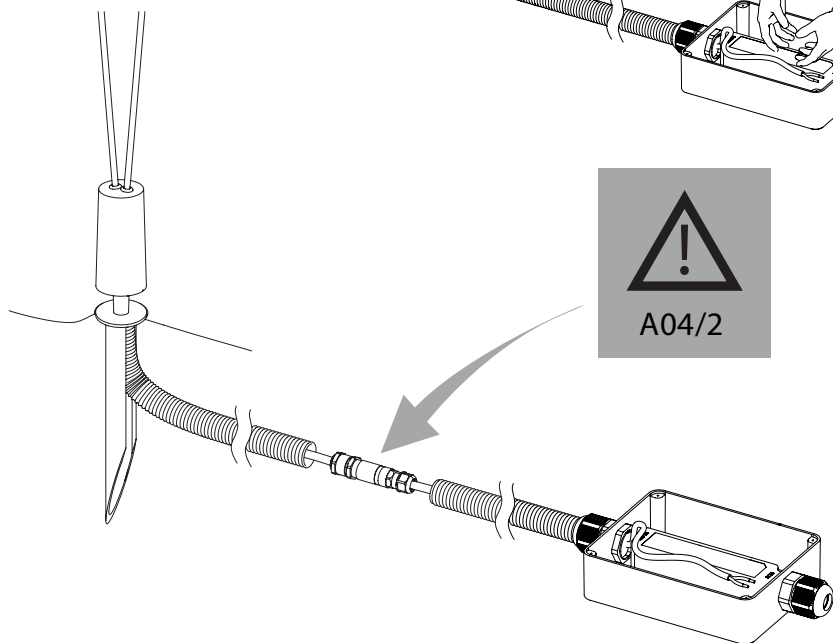
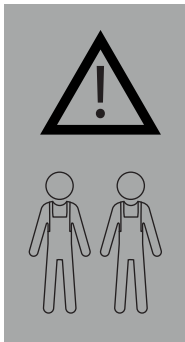
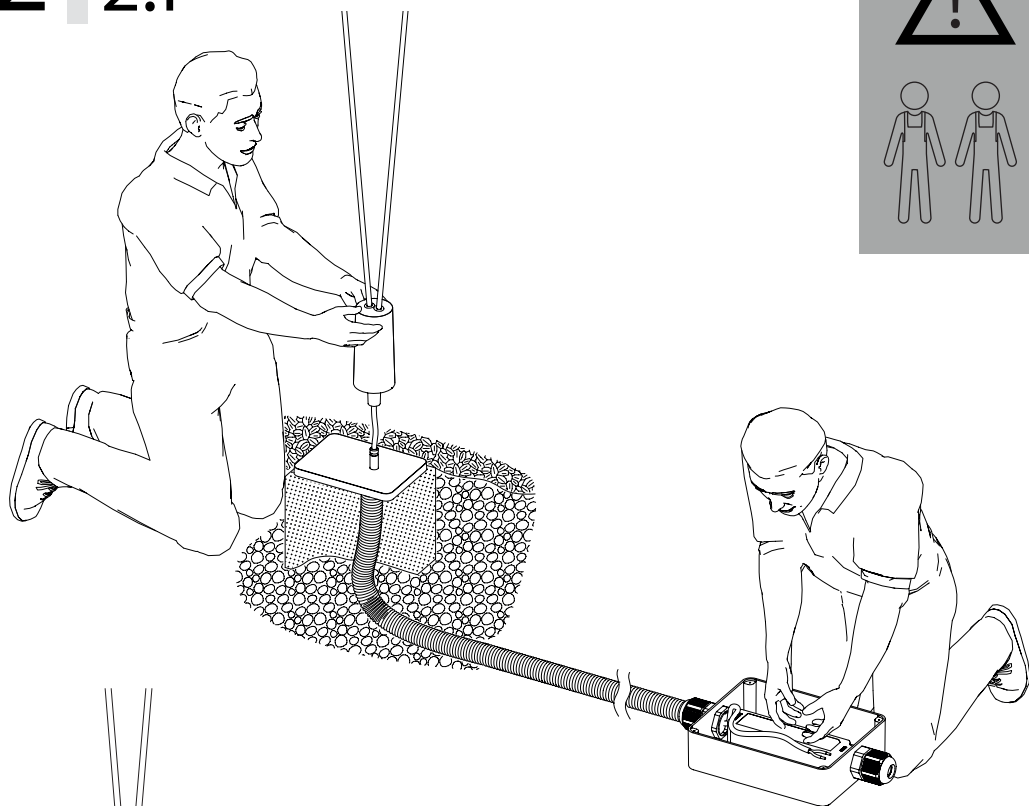

2.2

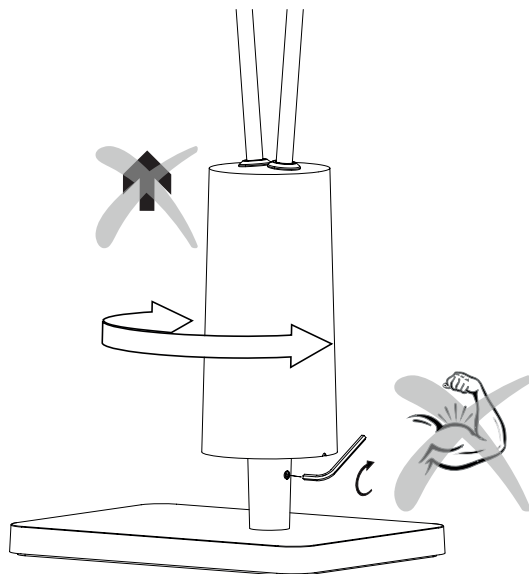

2.3

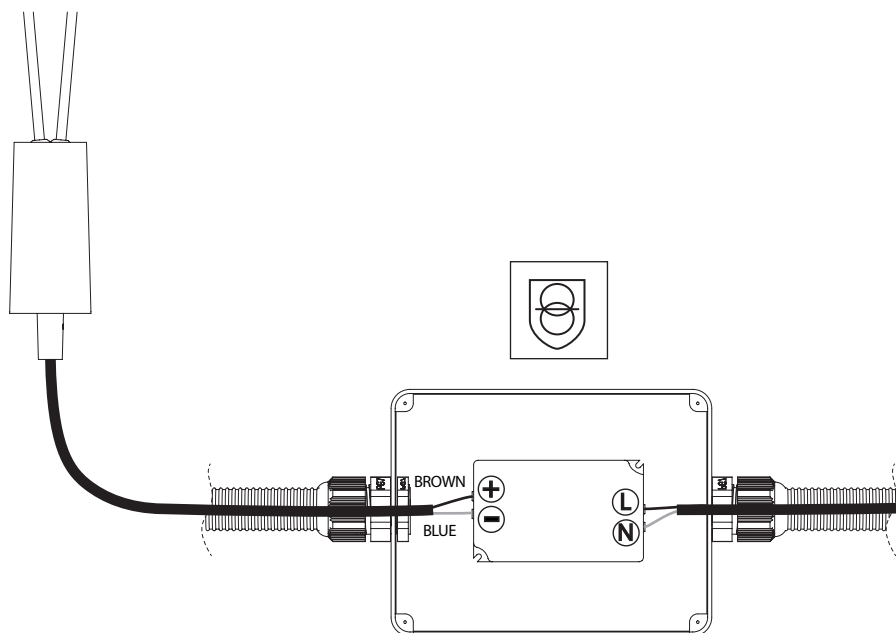

3 | 3.1

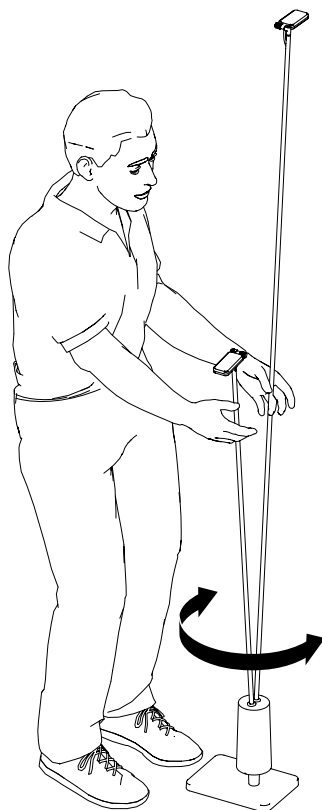

3.2

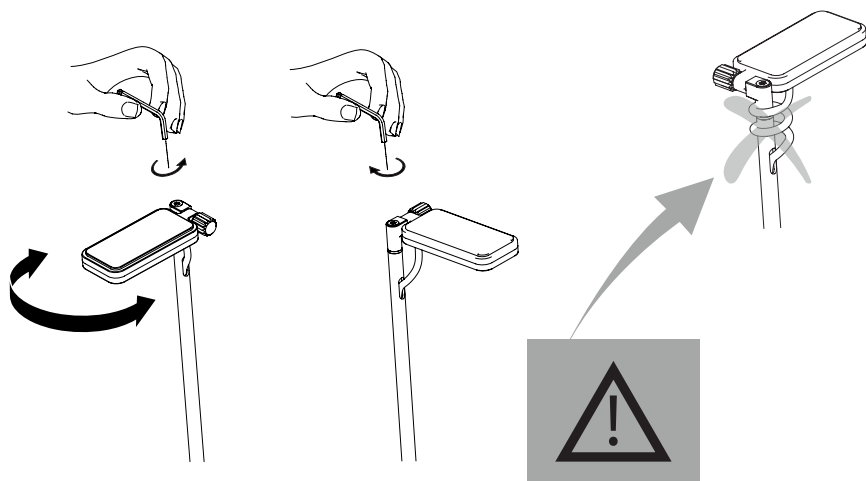

3.3

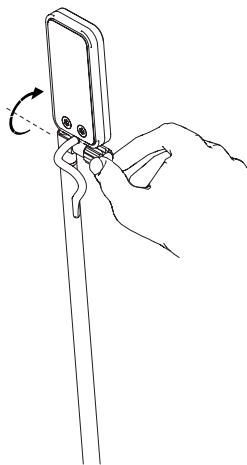
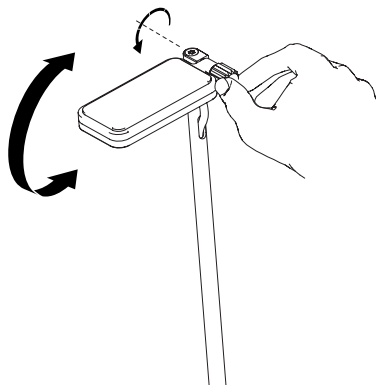

4

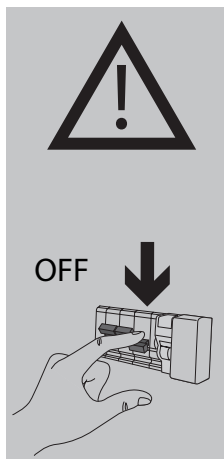

1.

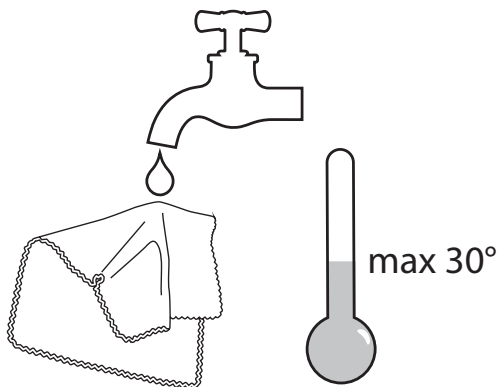

2.



3.

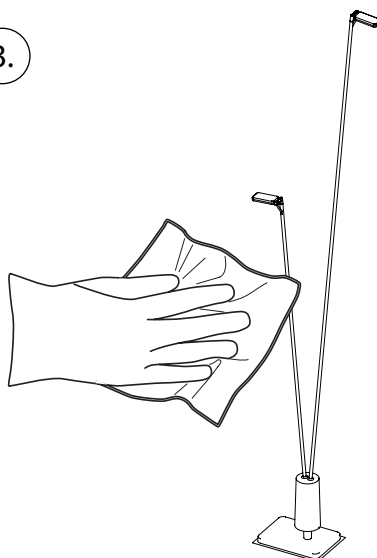



www.luceplan.com

A040IB002