

SUNSHINE

6925601345



User manual
Bedienungsanleitung
Mode d'emploi
Handleiding
Manuale
Manual del usuario
Használati utasítás
Instrukcja obsługi



LUTEC

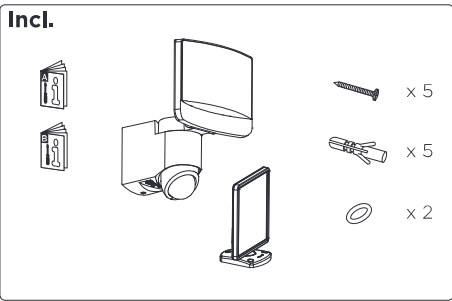

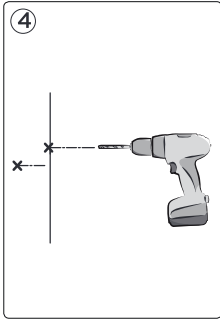
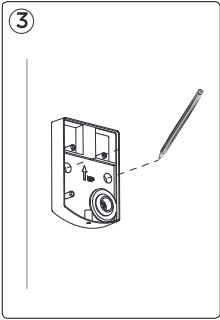
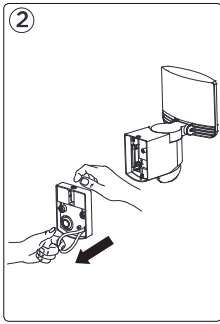
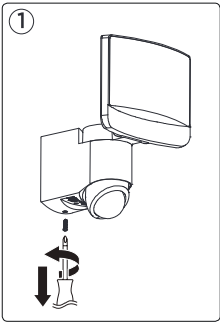

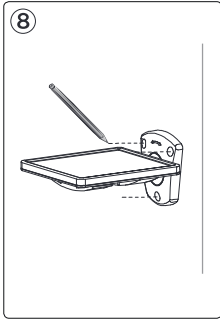
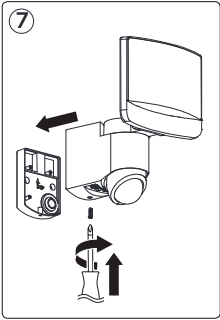
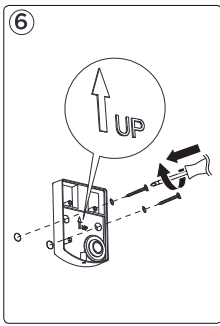
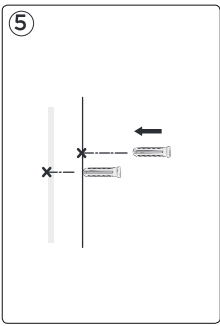

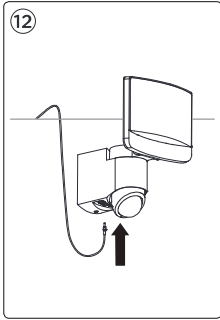
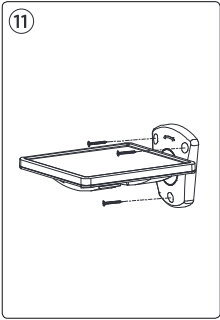
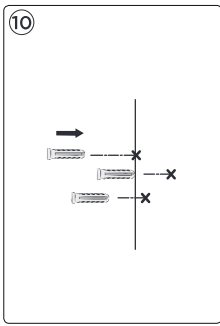
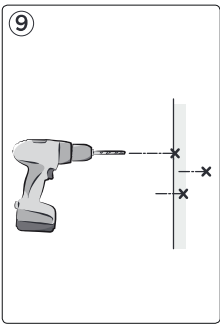

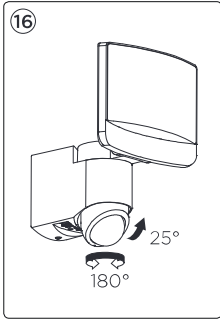
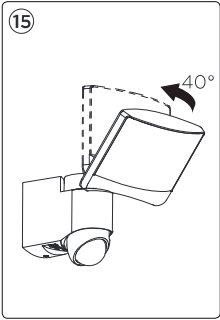
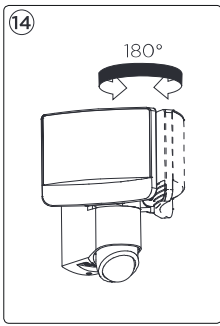
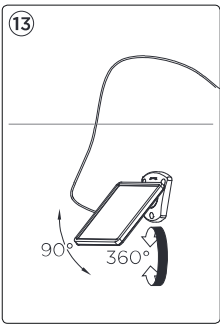

First Use

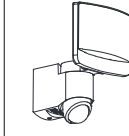
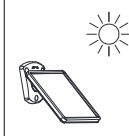

First Use: It is recommended to put the solar panel in the sun for 8 hours to charge the battery.

Erste Verwendung: Es wird empfohlen, das Solarpanel 8 Stunden lang in die Sonne zu legen, um den Akku aufzuladen.

Première utilisation: Il est recommandé de placer le panneau solaire au soleil pendant 8 heures pour charger la batterie.

Eerste gebruik: Het wordt aanbevolen om het zonnepaneel 8 uur in de zon te laten staan om de batterij op te laden.

Primo utilizzo: Si consiglia di mettere il pannello solare sotto il sole per 8 ore per caricare la batteria.

Primer uso: Se recomienda colocar el panel solar al sol durante 8 horas para cargar la batería.

Első használat: Javasoljuk, hogy a napelemet 8 órán keresztül a napsütésben töltsé fel az akkumulátor feltöltéséhez.

Pierwsze użycie: Zaleca się umieszczenie panelu słonecznego na słońcu na 8 godzin, aby naładować akumulator.

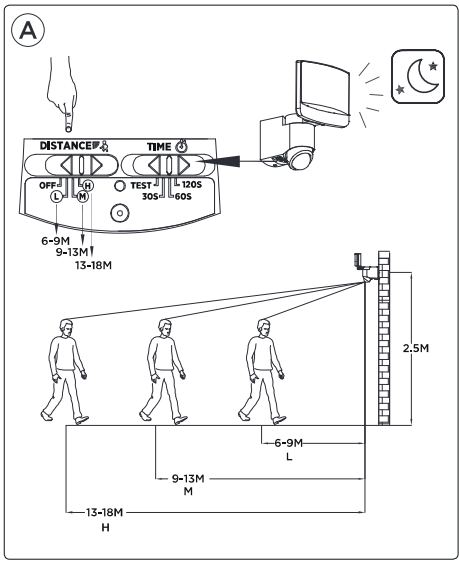

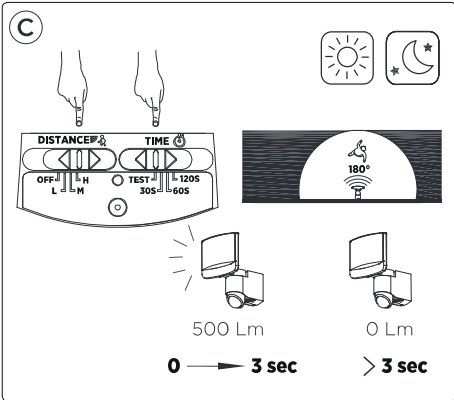
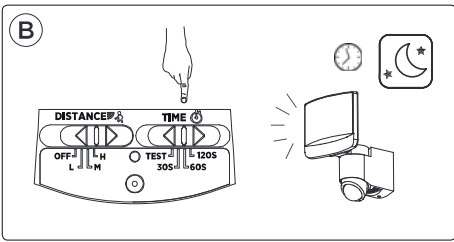

Battery Change

Batteriewechsel/Changement de Batterie/Cambio de
Baterías/Cambiar la Batteria/Batterij Vervangen
Wymiana Baterii/Akkumulatörsere

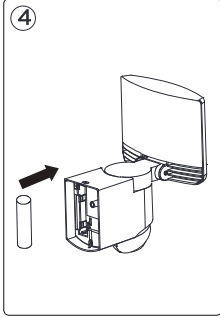
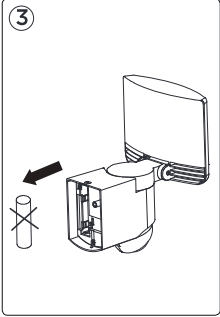
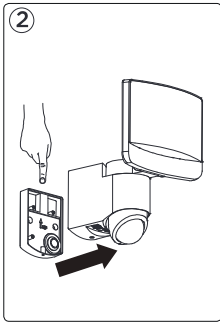
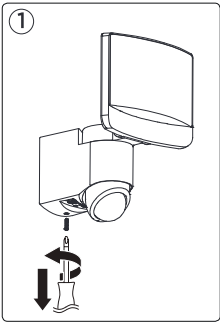

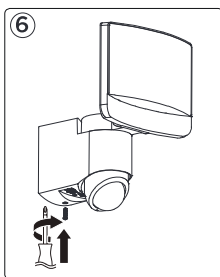
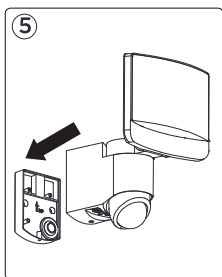

Safety

Safety:	<ul style="list-style-type: none"> • Do not expose the light to fire or intense heat. • Do not immerse the light into water. • Keep the solar panel clean.
Sicherheit:	<ul style="list-style-type: none"> • Setzen Sie das Licht weder Feuer noch starker Hitze aus. • Tauchen Sie das Licht nicht in Wasser. • Halten Sie das Solarpanel sauber.
Sécurité:	<ul style="list-style-type: none"> • Veuillez ne pas exposer la lumière à un feu ou à une chaleur intense. • Veuillez ne pas immerger la lumière dans l'eau. • Veuillez garder le panneau solaire propre.
Seguridad:	<ul style="list-style-type: none"> • No exponga la luz al fuego o calor intenso. • No sumerja la luz en el agua. • Mantenga el panel solar limpio.
Sicurezza:	<ul style="list-style-type: none"> • Non esporre la luce a fiamme o calore intenso. • Non immergere la luce nell'acqua. • Mantenere pulito il pannello solare.
Veiligheid:	<ul style="list-style-type: none"> • Stel het licht niet bloot aan vuur of intense hitte. • Dompel het licht niet onder in water. • Hou het zonnepaneel schoon.
Bezpieczeństwo:	<ul style="list-style-type: none"> • Nie należy poddawać lampki na bezpośrednie działanie ognia lub intensywnego ciepła. • Nie należy zanurzać lampki w wodzie. • Panel słoneczny należy utrzymywać w czystości.
Biztonság:	<ul style="list-style-type: none"> • Ne tegye ki a lámpát tűznek vagy intenzív hőhatásnak. • Ne merítse a lámpát vízbe. • Tartsa tisztán a napelemet.



LUTEC Europe NV

Herentalsebaan 425
B-2160 Wommelgem - Belgium
+32 3 284 51 62
info@lutec-europe.com
www.lutec.com



www.lutec.com/services/global-network

12

190903973