

10047658

5,5W LED / 6,3W Total
incl. LED Board: L9003404
220-240V ~ 50/60Hz

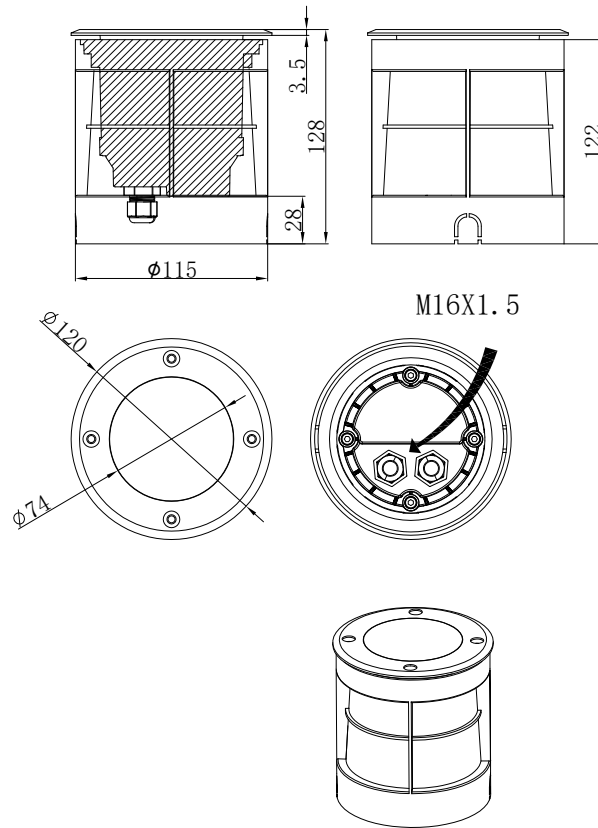

Maßeinheit/Unit of measure/ Unité de mesure: mm

(DE) Bestimmungsgemäße Verwendung

(EN) Intended use | (FR) Utilisation conforme | (NL) Beoogd gebruik | (PL) Stosowanie zgodnie z przeznaczeniem | (NO) Riktig bruk | (DK) Korrekt brug
(SE) Avsedd användning | (FI) Määräystenmukainen käyttö | (IT) Impiego appropriato | (ES) Uso prescrito | (CZ) Použití v souladu s určením
(PT) Utilização correta | (GR) Ενδεδειγμένη χρήση | (SK) Predpokladané použitie | (EE) Eeldatav kasutus | (LV) Paredzams lietojums
(LT) Numatomas naudojimas | (RO) Utilizare intenționată | (SI) Predvidena uporaba | (HR) Namjenska upotreba | (HU) Tervezett felhasználás
(BG) предназначена употреба | (AL) Përdorimi i parashikuar | (MK) Предвидена употреба | (TR) Amaçlı kullanım | (UK) Призначене використання
(BA,ME,RS) Namjenska upotreba

(DE)	Ortsfeste Verwendung als Bodeneinbauleuchte im Außenbereich	(GB)	Ground recessed light, provided for stationary outdoor use
(FR)	Installation fixe en tant que Spot encastré dans le sol, à l'extérieur	(NL)	Vast gebruik als Grondinbouwspot buitenshuis
(PL)	Do montażu stacjonarnego jako lampa wpuszczana w podłozę na zewnątrz	(NO)	Til stasjonært bruk som nedfelt lampe utendørs
(DK)	Til stationær brug som nedgravet lampe udendørs	(SE)	Används som fast markinbyggnadslampa utomhus
(FI)	Kiinteä käyttö ulkotilojen upotettavana maavalo	(IT)	Impiego fisso come faretto da incasso da terra in ambienti esterni
(ES)	Empleo fijo en tanto lámpara empotrable en el suelo en el exterior	(CZ)	Stacionární použití jako podlahové zabudované svítidlo v exteriéru
(PT)	Aplicação fixa como foco de chão de montagem encastrada em exteriores	(GR)	Σταθερή χρήση ως χωνευτό φωτιστικό δαπέδου σε εξωτερικό χώρο
(SK)	Stacionárne použitie ako vonkajšie svetlo na zabudovanie do podlahy	(BG)	Стационарно използване като вградена подова лампа на открито
(EE)	Püsiva kasutusega pörandasse paigaldatav valgusti välitingimustes	(LV)	Stacionāra izmantošana kā iebūvējama grīdas lampa ārā
(LT)	Stacionarus naudojimas kaip įmontuojama grindų lempa lauke	(RO)	Utilizare fixă ca lampă de podea încorporată în exterior
(SI)	Stacionarna uporaba kot vgradna tla svetilka na prostem	(HR)	Stalna upotreba kao ugrađena podna lampa na otvorenom
(HU)	Állandó használatra szánt, beépített padlólámpa kültéri használatra	(AL)	Drita e thellë e tokës, e siguruar për përdorim jashtë
(MK)	Земна вградена светилка, наменета за стационарна надворешна употреба	(TR)	Yerleşik dış mekan kullanımı için yerleştirilmiş zemin gömme ışık
(UK)	Земельний вбудований світильник, призначений для стаціонарного використання на вулиці	(BA)	Ugradna svjetiljka u tlu, namijenjena za stacionarnu upotrebu na otvorenom
		(ME)	
		(RS)	

(DE) Lieferumfang (EN) Package contents (FR) Contenu de la livraison (NL) Bij de levering inbegrepen (PL) Zakres dostawy (NO) Levering (DK) Leveringsomfang (SE) Leveransomfattning (FI) Toimitussisältö (IT) Fornitura (ES) Volumen de suministro (CZ) Rozsah dodávky (PT) Material fornecido (GR) Παραδοτέος εξοπλισμός (SK) Obsah balenia (EE) Pakendi sisu (LV) Pakas saturs (LT) Pakuotės turinys (RO) Conținutul pachetului (SI) Vsebina paketa (HR) Sadržaj paketa (HU) A csomag tartalma (BG) обхват на доставката (AL) Përmbajtja e dorëzimit (MK) Содржина на испорака (TR) Teslimat içeriği (UK) Зміст доставки (BA,ME,RS) Sadržaj isporuke		
(DE) 1 Bodeneinbauleuchte Montagematerial Montageanleitung	(GB) 1 Ground recessed light Installation hardware Mounting instructions	(FR) 1 Spot encastré dans le sol Matériel de montage Instructions de montage
(NL) 1 Grondinbouwspot Monteringsmateriale Montagehandleiding	(PL) 1 Lampa wpuszczana w podłoże Elementy montażowe Instrukcja montażu	(NO) 1 Nedfelt lampe Monteringsmateriale Brukerveiledning
(DK) 1 Nedgravet lampe Monteringsmateriale Brugervejledning	(SE) Markinbyggnadslampa Monteringsmaterial Monteringsanvisning	(FI) 1 Upotettava maavalo Asennusmateriaali Asennusohjeet
(IT) 1 Faretto da incasso da terra Materiale di montaggio Istruzioni di montaggio	(ES) 1 Lámpara empotrable en el suelo Material de montaje Instrucciones de montaje	(CZ) 1 Podlahové zabudované svítidlo Materiál pro montáž Návod k montáži
(PT) 1 Foco de chão de montagem encastrada Material de montagem Instruções de montagem	(GR) 1 Χωνευτό φωτιστικό δαπέδου Υλικό συναρμολόγησης Οδηγίες συναρμολόγησης	(SK) 1 Podlahová vstavaná lampa Inštalacný hardvér Inštalčná príručka
(BG) 1 Вградена подова лампа материали за монтаж инструкции за монтаж	(EE) 1 Põrandasse paigaldatav valgusti Paigaldustarvikud Paigaldusjuhend	(LV) 1 Iebūvējama grīdas lampa Instalācijas aparātūra Uzstādīšanas instrukcija
(LT) 1 Įmontuojama grindų lempa Montavimo aparatinė įranga Montavimo instrukcija	(RO) 1 Lampă de podea încorporată Hardware de instalare Instrucțiuni de montare	(SI) 1 Vgradna tla svetilka Namestitvena strojna oprema Navodila za montažo
(HR) 1 Ugrađena podna lampa Instalacijski hardver Upute za montažu	(HU) 1 Beépített padlólámpa Telepítési hardver Szerelési útmutató	(AL) 1 dritë e fshehur në tokë Materiali i montimit Udhëzuesi i montimit
(MK) 1 вградена светилка на под Монтажен материјал Упатство за монтажа	(TR) 1 yerleşik zemin lambası Montaj malzemesi Montaj kılavuzu	(UK) 1 вбудована підлогова лампа Монтажний матеріал Інструкція з монтажу
(BA) 1 ugradbena podna svjetiljka (ME) Montažni materijal (RS) Uputstvo za montažu		

ARCCHIO

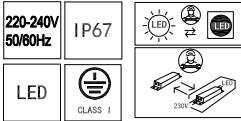

Nennlast MAX. 5 kN
 Max. Oberflächentemperatur 40 °C
 Rated load MAX. 5KN
 Max. surface temperature 40°C
 Charge nominale MAX. 5 kN
 Température maximale de surface 40 °C

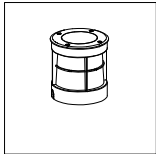
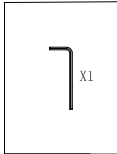

EN This product contains light source(s) of energy efficiency class(es)

1.

2.

3.

4.

INCOMING SUPPLY

TO FITTING

LIVE (Brown or Red) ————

EARTH (Green & Yellow) ————

NEUTRAL (Blue or Black) ————

5.

6.

	(DE)	(EN)	(FR)	(NL)	(PL)	(NO)
L	Stromführender Leiter	Live conductor	Conducteur	Spanningvoerende draad	Przewód prądowy	Strømførende leder
	Schutzleiter	Earth conductor	Conducteur de protection (terre)	Aardkabel	Przewód uziemiający	Jordledningen
N	Neutralleiter	Neutral conductor	Conducteur neutre	Nulleider	Przewód zerowy	Nøytralleider

	(DK)	(SE)	(FI)	(IT)	(ES)	(CZ)
L	Strømførende leder	Strömförande ledare	Virtajohdin	Conduttore sotto tensione	Conductor de corriente	Vodič pod napětím
	Jordledningen	Skyddsledare	Suojajohdin	Conduttore di terra	Conductor de protección	Ochranný vodič
N	Neutralleider	Neutralledare	Nollajohdin	Conduttore neutro	Conductor neutro	Neutrální vodič

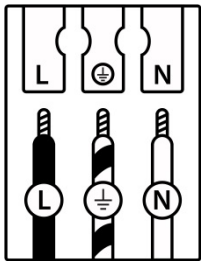

	(PT)	(GR)	(SK)	(EE)	(LV)	(LT)
L	Condutor vivo	Ρευματοφόρος αγωγός	Živý vodič	Faasisjuht	Dzīvais vadītājs	Gyvas dirigentas
	Condutor de terra	Αγωγός γείωσης	Zemný vodič	Maandusjuht	Zemes vadītājs	Žemės dirigentas
N	Condutor neutro	Ουδέτερος αγωγός	Neutrálný vodič	Neutraaljuht	Neitrālais vadītājs	Neutrinis dirigentas

	(RO)	(SI)	(HR)	(HU)	(BG)	(AL)
L	Conductor viu	Živi dirigent	Živi dirigent	Élő vezető	проводник под напряжение	Konduktor i gjallë
	Conductor de împământare	Zemeljski dirigent	Uzemljeni dirigent	Földvezető	защитен проводник	Dirigjent i tokës
N	Conductor neutru	Nevtralni dirigent	Neutralni dirigent	Semleges vezető	нулев проводник	Konduktor neutral

	(MK)	(TR)	(UK)	(BA)(ME)(RS)
L	Жив кондуктор	Canlı yönetici	Живий диригент	Živi dirigent
	Земјен проводник	Toprak iletkeni	Земельний провідник	Zemaljski provodnik
N	Неутрален проводник	Nötr iletken	Нейтральный провідник	Neutralni provodnik

(DE) Verwendete Symbole

(EN) Safety Precautions | (FR) Symboles utilisés | (NL) Gebruikte symbolen | (PL) Stosowane symbole | (NO) Brukte symboler | (DK) Brugte symboler
 (SE) Använda symboler | (FI) Käytetyt symbolit | (IT) Simboli usati | (ES) Símbolos empleados | (CZ) Použité symboly | (PT) Símbolos utilizados
 (GR) Χρησιμοποιούμενα σύμβολα | (SK) Bezpečnostné opatrenia | (EE) Ohutusabinõud | (LV) Drošības pasākumi
 (LT) Saugos priemonės | (RO) Măsuri de precauție | (SI) Varnostni ukrepi | (HR) Mjere opreza | (HU) Használt szimbólumok | (BG) Мерки за безопасност
 (AL) Simbolet e përdorura | (MK) Користени симболи | (TR) Kullanılan semboller | (UK) Використовувані символи | (BA,ME,RS) Korišteni simboli

IP 67

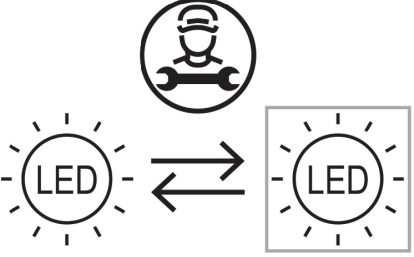

<p>(DE) Dieses Produkt enthält eine Lichtquelle der Energieeffizienzklasse E (EN) This product contains a light source of energy efficiency class E (FR) Ce produit comprend une source de lumière de classe d'efficacité énergétique E (NL) Dit product bevat een lichtbron van energie-efficiëntieklasse E (PL) Produkt ten zawiera źródło światła o klasie efektywności energetycznej E (NO) Dette produktet inneholder en lyskilde i energieeffektivitetsklasse E (DK) Dette produkt indeholder en lyskilde af energieeffektklasse E (SE) Denna produkt innehåller en ljuskälla i energieffektivitetsklass E (FI) Tämä tuote sisältää energiatehokkuusluokan E valonlähteen (IT) Questo prodotto contiene una sorgente luminosa della classe di efficienza energetica E (ES) Este producto contiene una fuente de luz de la clase de eficiencia energética E (CZ) Tento výrobek obsahuje světelný zdroj třídy energetické účinnosti E (PT) Este produto contém uma fonte de luz da classe de eficiência energética E (GR) Αυτό το προϊόν περιέχει μια φωτεινή πηγή ενεργειακής απόδοσης κλάσης E (SK) Tento výrobok obsahuje zdroj svetla triedy energetickej efektivity E (EE) See toode sisaldab energiatõhususklassi E valgusallikat (LV) Šis produkts satur enerģijas efektivitātes klases E gaismas avotu (LT) Šis gaminys turi energijos efektyvumo klasės E šviesos šaltinį (RO) Acest produs conține o sursă de lumină de clasă de eficiență energetică E (SI) Ta izdelek vsebuje svetlobni vir energijskega razreda E (HR) Ovaj proizvod sadrži izvor svjetlosti energetske učinkovitosti klase E (HU) Ez a termék egy E energiahatékonysági osztályú fényforrást tartalmaz (BG) Този продукт съдържа източник на светлина с клас на енергийна ефективност: E (AL) Ky produkt përmban një burim drite të klasës së efikasitetit të energjisë E (MK) Овој производ содржи извор на светлина од класа на енергетска ефикасност E (TR) Bu ürün, enerji verimliliği sınıfı E olan bir ışık kaynağı içerir (UK) Цей продукт містить джерело світла класу енергоефективності E (BA)(ME)(RS) Ovaj proizvod sadrži izvor svjetlosti energetske klase E</p>	<p>QR</p> 	<p>EAN</p> <p>4255830913389</p>
--	---	---------------------------------

	<p>(DE) Durch einen Fachmann austauschbare Lichtquelle (nur LED). (EN) Replaceable (LED only) light source by a professional. (FR) Source de lumière remplaçable (LED uniquement) par un professionnel. (NL) Lichtbron (alleen led) te vervangen door een professional. (PL) Wymienne (tylko LED) źródło światła wykonane przez profesjonalistę. (NO) Utskiftbar (kun LED) lyskilde av en profesjonell. (DK) Udskiftelig lyskilde (kun LED), udskiftes af en elektriker. (SE) Ljuskälla (endast LED) utbytbar genom fackman. (FI) Ammatillainen voi vaihtaa vaihdettavan (vain LED) valonlähteen. (IT) Sorgente luminosa (solo LED) sostituibile da un professionista. (ES) Fuente de luz (solo LED) sustituible por un profesional. (CZ) Vyměnitelný (pouze LED) světelný zdroj odborníkem. (PT) Luz LED (apenas LED) substituível por um profissional. (GR) Η πηγή φωτός (μόνο LED) να αντικαθίσταται από επαγγελματία. (SK) Zdroj svetla (iba LED) vymeniteľný prostredníctvom odborníka. (EE) Spetsialisti poolt vahetatav valgusallikas (ainult LED). (LV) Speciālista maināms gaismas avots (tikai LED). (LT) Specialisto keičiamas šviesos šaltinis (tik LED). (RO) Sursă de lumină schimbabilă de către un specialist (doar LED). (SI) Svetlobni vir, ki ga lahko zamenja strokovnjak (samo LED). (HR) Izvor svjetlosti koji može zamijeniti stručnjak (samo LED). (HU) Szakember által cserélhető (csak LED) fényforrás. (BG) Светлинен източник, който може да се смени от специалист (само LED). (AL) Burim drite i zëvendësueshëm (LED vetëm) nga një profesionist. (MK) Изворот на светлина (само LED) се заменува од професионалец. (TR) Değiştirilebilir (yalnızca LED) ışık kaynağı bir profesyonel tarafından değiştirilir. (UK) Замінний (тільки LED) джерело світла замінюється фахівцем. (BA)(ME)(RS) Zamjenjiv (samo LED) izvor svjetlosti zamjenjuje profesionalac.</p>
---	--



- (DE) Durch einen Fachmann austauschbares Betriebsgerät.
 (EN) Replaceable control gear by a professional.
 (FR) Contrôleur remplaçable par un professionnel.
 (NL) Voorschakelapparatuur te vervangen door een professional.
 (PL) Wymienny układ sterujący przez profesjonalistę.
 (NO) Utskiftbar kontrollutstyr av en profesjonell.
 (DK) Udskiftelig igangsætter, udskiftes af en elektriker.
 (SE) Styrdon utbytbar genom fackman.
 (FI) Ammattilainen voi vaihtaa vaihdettavat ohjauslaitteet.
 (IT) Dispositivo di controllo sostituibile da un professionista.
 (ES) Dispositivo de control sustituible por un profesional.
 (CZ) Vyměnitelný předřadník odborníkem.
 (PT) Dispositivo de controlo substituível por um profissional.
 (GR) Ο εξοπλισμός ελέγχου να αντικαθίσταται από επαγγελματία.
 (SK) Predradník vymeniteľný prostredníctvom odborníka.
 (EE) Spetsialisti poolt vahetatav juhtseade.
 (LV) Speciālista maināma vadības iekārta.
 (LT) Specialisto keičiamas valdymo įrenginys.
 (RO) Aparat de comandă schimbabil de către un specialist.
 (SI) Nadomestna krmilna naprava, ki jo lahko zamenja strokovnjak.
 (HR) Zamjenjivi upravljački sklop koji može zamijeniti stručnjak.
 (HU) Szakember által cserélhető vezérlőszerkezet.
 (BG) Уред, който може да се смени от специалист.
 (AL) Pajisje kontrolli e zëvendësueshme nga një profesionist.
 (MK) Заменлива контролна опрема од страна на професионалец.
 (TR) Profesyonel tarafından değiştirilebilir kontrol donanımı.
 (UK) Замінний контрольний пристрій фахівцем.
 (BA)(ME)(RS) Zamjenjiva kontrolna oprema od strane profesionalca.