

5257017

5,4W LED
incl. LED Board: L9002437
220-240V ~ 50/60Hz

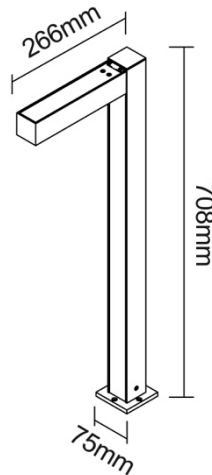

(DE) Bestimmungsgemäße Verwendung

(GB) Intended use / (FR) Utilisation conforme / (NL) Beoogd gebruik / (PL) Stosowanie zgodnie z przeznaczeniem /
(NO) Riktig bruk / (DK) Korrekt brug / (SE) Avsedd användning / (FI) Määräystenmukainen käyttö
(IT) Impiego appropriato / (ES) Uso prescrito / (CZ) Použití v souladu s určením / (PT) Utilização correta / (GR) Ενδεικτική χρήση

(DE)	Ortsfeste Verwendung an Wegen/in Beeten im Außenbereich	(GB)	Provided for stationary outdoor use on trails / flower beds
(FR)	Pose fixe le long des allées/des parterres de plantes, à l'extérieur	(NL)	Vast gebruik langs paden en bloembedden buitenshuis
(PL)	Do montażu stacjonarnego na zewnątrz przy drogach/ grządkach	(NO)	Til stasjonært bruk på veier og i bed utendørs
(DK)	Til stationær brug på veje og i bed udendørs	(SE)	Fast användning vid stigar/rabatter utomhus
(FI)	Kiinteä käyttö ulkotilojen kulkureiteillä/kukkapenkeissä	(IT)	Impiego fisso su sentieri/aiuole in ambienti esterni
(ES)	Empleo fijo en caminos / jardineras en el exterior	(CZ)	Stacionární použití jako cestiček u záhonů v exteriéru
(PT)	Aplicação fixa para caminhos/ canteiros em exteriores	(GR)	Σταθερή χρήση σε διαδρόμους/παρτέρια σε εξωτερικό χώρο

(DE) Verwendete Symbole

(GB) Safety Precautions / (FR) Symboles utilisés / (NL) Gebruikte symbolen / (PL) Stosowane symbole / (NO) Brukte symboler /
(DK) Brugte symboler / (SE) Använda symboler / (FI) Käytetyt symbolit / (IT) Simboli usati / (ES) Símbolos empleados /
(CZ) Použité symboly / (PT) Símbolos utilizados / (GR) Χρησιμοποιούμενα σύμβολα

IP 65



(DE) Lieferumfang

(GB) Package contents / (FR) Contenu de la livraison / (NL) Bij de levering inbegrepen / (PL) Zakres dostawy / (NO) Levering /
(DK) Leveringsomfang / (SE) Leveransomfattning / (FI) Toimitussisältö / (IT) Fornitura / (ES) Volumen de suministro /
(CZ) Rozsah dodávky / (PT) Material fornecido / (GR) Παραδοτέος εξοπλισμός

(DE)	1 Wegeleuchte Montagematerial Montageanleitung	(GB)	1 Street and path light Installation hardware Mounting instructions	(FR)	1 Borne lumineuse Matériel de montage Instructions de montage
(NL)	1 Padverlichting Monteringsmateriale Montagehandleiding	(PL)	1 Słupek oświetleniowy Elementy montażowe Instrukcja montażu	(NO)	1 Gatelampe Monteringsmateriale Brukerveiledning
(DK)	1 Gadelys Monteringsmateriale Brugervejledning	(SE)	1 Väglykta Monteringsmaterial Monteringsanvisning	(FI)	1 Pylväsvalaisin Asennusmateriaali Asennusohjeet
(IT)	1 Lampioncino Materiale di montaggio Istruzioni di montaggio	(ES)	1 Lámpara para caminos Material de montaje Instrucciones de montaje	(CZ)	1 Osvětlení cestiček Materiál pro montáž Návod k montáži
(PT)	1 Luminária técnica Material de montagem Instruções de montagem	(GR)	1 Φωτιστικό διαδρόμων Υλικό συναρμολόγησης Οδηγίες συναρμολόγησης		

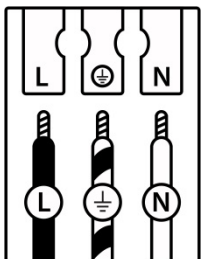
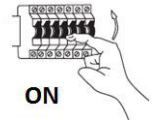
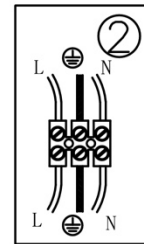
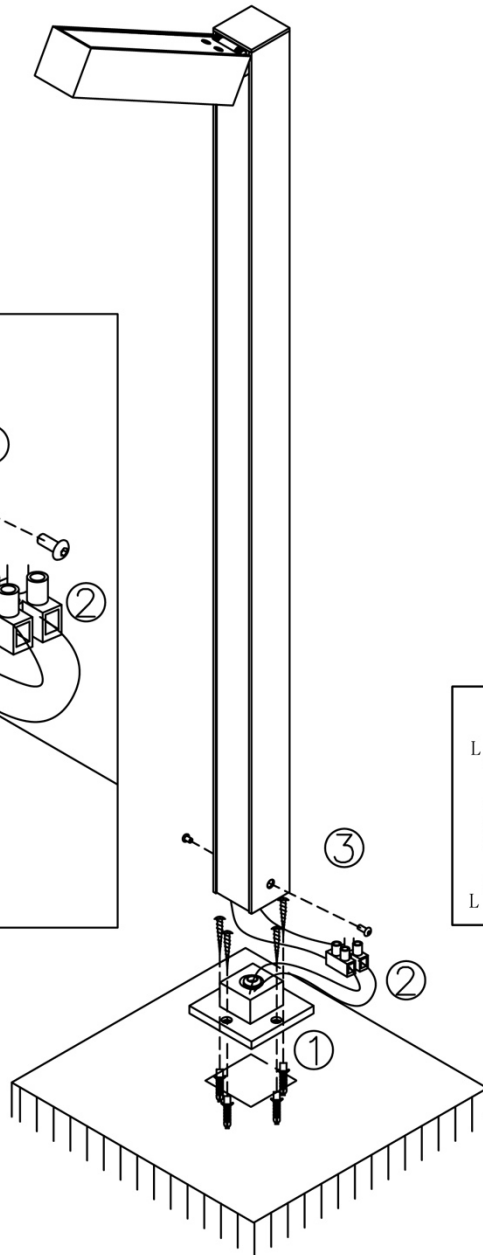
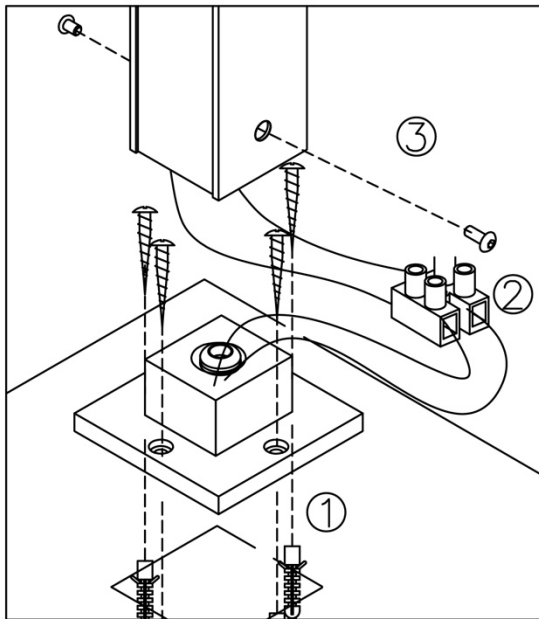
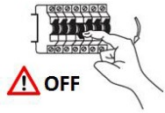

	(DE)	(GB)	(FR)	(NL)	(PL)	(NO)	(DK)
L	Stromführender Leiter	Live conductor	Conducteur	Spanningvoerende draad	Przewód prądowy	Strømførende leder	Strømførende leder
	Schutzleiter	Earth conductor	Conducteur de protection (terre)	Aardkabel	Przewód uziemiający	Jordledningen	Jordledningen
N	Neutralleiter	Neutral conductor	Conducteur neutre	Nulleider	Przewód zerowy	Nøytralleider	Neutralleider

	(SE)	(FI)	(IT)	(ES)	(CZ)	(PT)	(GR)
L	Strömförande ledare	Virtajohdin	Conduttore sotto tensione	Líneas conductoras de corriente	Vodič pod napětím	Condutor vivo	Ρευματοφόρος αγωγός
	Skyddsledare	Suojajohdin	Conduttore di terra	Conductor de protección	Ochranný vodič	Condutor de terra	Αγωγός γείωσης
N	Neutralledare	Nollajohdin	Conduttore neutro	Conductor neutro	Neutrální vodič	Condutor neutro	Ουδέτερος αγωγός

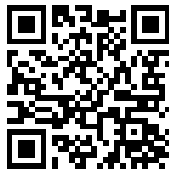
	QR	EAN
<p>(DE) Dieses Produkt enthält eine Lichtquelle der Energieeffizienzklasse G (EN) This product contains a light source of energy efficiency class G (FR) Ce produit comprend une source de lumière de classe d'efficacité énergétique G (NL) Dit product bevat een lichtbron van energie-efficiëntieklasse G (PL) Produkt ten zawiera źródło światła o klasie efektywności energetycznej G (NO) Dette produktet inneholder en lyskilde i energieeffektivitetsklasse G (DK) Dette produkt indeholder en lyskilde af energieeffektklasse G (SE) Denna produkt innehåller en ljuskälla i energieffektivitetsklass G (FI) Tämä tuote sisältää energiatehokkuusluokan G valonlähteen (IT) Questo prodotto contiene una sorgente luminosa della classe di efficienza energetica G (ES) Este producto contiene una fuente de luz de la clase de eficiencia energética G (CZ) Tento výrobek obsahuje světelný zdroj třídy energetické účinnosti G (PT) Este produto contém uma fonte de luz da classe de eficiência energética G (GR) Αυτό το προϊόν περιέχει μια φωτεινή πηγή ενεργειακής απόδοσης κλάσης G (SK) Tento výrobok obsahuje zdroj svetla triedy energetickej efektivity G</p>		<p>4251911753400</p>

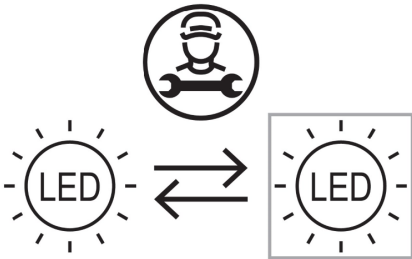
	<p>(DE) Durch einen Fachmann austauschbare Lichtquelle (nur LED). (EN) Replaceable (LED only) light source by a professional. (FR) Source de lumière remplaçable (LED uniquement) par un professionnel. (NL) Lichtbron (alleen led) te vervangen door een professional. (PL) Wymienne (tylko LED) źródło światła wykonane przez profesjonalistę. (NO) Utskiftbar (kun LED) lyskilde av en profesjonell. (DK) Udskiftelig lyskilde (kun LED), udskiftes af en elektriker. (SE) Ljuskälla (endast LED) utbytbar genom fackman. (FI) Ammattilainen voi vaihtaa vaihdettavan (vain LED) valonlähteen. (IT) Sorgente luminosa (solo LED) sostituibile da un professionista. (ES) Fuente de luz (solo LED) sustituible por un profesional. (CZ) Vyměnitelný (pouze LED) světelný zdroj odborníkem. (PT) Luz LED (apenas LED) substituível por um profissional. (GR) Η πηγή φωτός (μόνο LED) να αντικαθίσταται από επαγγελματία. (SK) Zdroj svetla (iba LED) vymeniteľný prostredníctvom odborníka.</p>
--	--

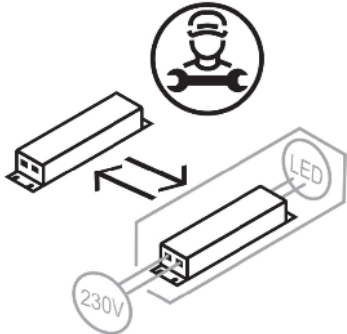
	<p>(DE) Durch einen Fachmann austauschbares Betriebsgerät. (EN) Replaceable control gear by a professional. (FR) Contrôleur remplaçable par un professionnel. (NL) Voorschakelapparatuur te vervangen door een professional. (PL) Wymienny układ sterujący przez profesjonalistę. (NO) Utskiftbar kontrollutstyr av en profesjonell. (DK) Udskiftelig igangsætter, udskiftes af en elektriker. (SE) Styrdon utbytbar genom fackman. (FI) Ammattilainen voi vaihtaa vaihdettavat ohjauslaitteet. (IT) Dispositivo di controllo sostituibile da un professionista. (ES) Dispositivo de control sustituible por un profesional. (CZ) Vyměnitelný předřadník odborníkem. (PT) Dispositivo de controlo substituível por um profissional. (GR) Ο εξοπλισμός ελέγχου να αντικαθίσταται από επαγγελματία. (SK) Predradník vymeniteľný prostredníctvom odborníka.</p>
---	--