

Instructions



Blown SW3 Samuel Wilkinson 2014

Congratulations with your new Blown lamp, designed in 2014 by Samuel Wilkinson. We hope you will enjoy using this product and follow these instructions to ensure correct installation. If you have any questions or comments, please do not hesitate to contact us by mail on:

info@andtradition.com

Blown SW3 Samuel Wilkinson 2014

Please read these instructions carefully and retain them for future reference to ensure that the product is used correctly. For your own safety, please study each step of this instruction manual first. &Tradition is not responsible for any faults or damages caused by not following these instructions correctly. Do not modify this product in any way.

Contents

- A Shade
- B Canopy with metal ceiling bracket & connection box

Tools needed

- Bulb type E27

Safety precautions

- Dispose of plastic bag from packaging and do not allow children to play with it.
- Keep product well out of children's reach.
- The product is only intended for interior use.
- Do not attempt installation of product if you are not competent to do so yourself.
- Consult a professionally qualified electrician if in any doubt.
- Disconnect the electricity supply at the fuse box, before commencing work.

Cleaning instructions

- Wipe surface of lamp shade with a soft, damp sponge or cloth, and wipe immediately after with a dry cloth.
- Do not use any abrasive cleaning tools such as steel wool, scouring sponges or stiff brushes.
- Never use strong cleaning agents such as white spirit, turpentine, household glass cleaner or cellulose thinners.

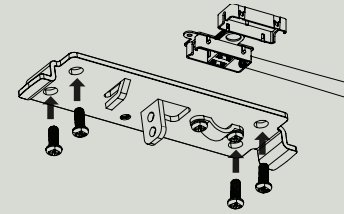
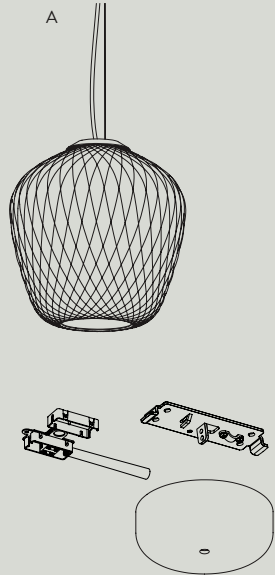

Step 1

Ensure power supply is turned off and remove any existing lamp fitting.

Locate the supply cable and ensure it is ready to be fitted to the connector block.

Mount the metal bracket (B) securely in the ceiling with screws and wall plugs, appropriate for the ceiling of installation.

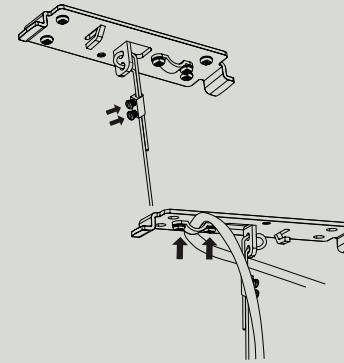

Step 2

To determine the right suspension height for the lamp, pass the safety wire through the metal bracket, find the desired height and make sure that the safety wire is blocked with the two screws. The excess wire can be cut after assuring the safety wire is blocked. Afterwards pass the electrical cable through the metal bracket and tighten the two screws to secure it.

The safety wire must always be shorter than the electrical cable during and after installation.

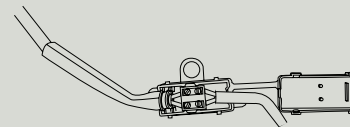

Step 3

Connecting the wires:

Pass the supply cable through the isolation sleeve. Cut off the excess cord using so that a minimum of 80 mm cord is left to reconnect to the cable connector. Peel back the outer cable using to expose 30 mm of the blue and brown inner cables. Strip the inner cable to expose 5 mm of wire.

Connect the blue wire (N) to the terminal of the connector marked 'N'.

Connect the brown supply (L) to the terminal of the connector marked 'L'.

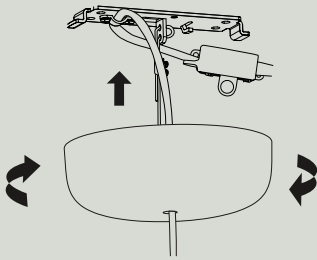

Step 4

Close the connection box, and install the plastic canopy onto the metal plate.

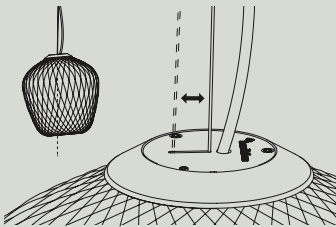

Step 5

In case the lamp (A) is not hanging straight, the lamp can be balanced by sliding the safety wire to adjust the weight balance.

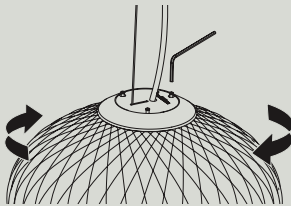

Step 6

If necessary, the metal fitting on the glass shade can be loosened slightly and turned so the weight can be adjusted in another direction.

Important: Only loosen the three screws enough to be able to turn the metal fitting on the glass - do not remove the fitting completely from the glass shade. Remember to tighten the screws again.

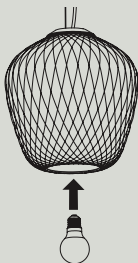

Step 7

Install the light bulb.

&Tradition®