

Hashira Floor Lamp, High

by Norm Architects

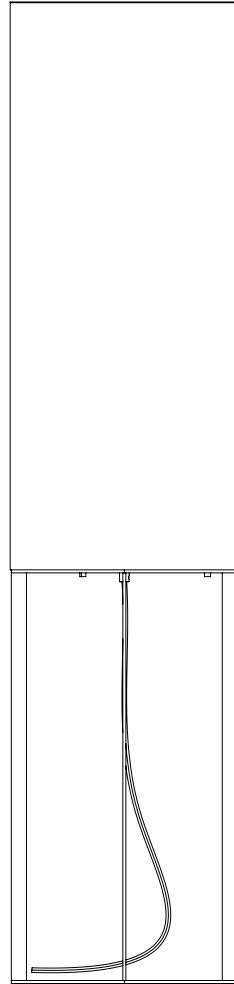

Congratulations with your new Hashira Floor Lamp, High designed by Norm Architects.

We hope you will enjoy using it. Please follow these instructions carefully to ensure the safe and correct installation of your new lamp. Read the entire instructional manual before starting the installation.

COMPONENT OVERVIEW

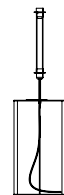

1 x Floor frame



1 x Textile shade

TECHNICAL SPECIFICATIONS

TECHNICAL DETAILS

Plug: UL certified plug

Cord: UL certified cord

THE LAMP RANGE IS TESTED ACCORDING TO

Floor lamp: UL 153

DIMMER

Dimmer on the cord.

LIGHTSOURCE DETAILS:

E26 Bulb not included

MAX 2x40W TYPE A

IMPORTANT SAFETY INSTRUCTIONS CONSIGNES DE SECURITE IMPORTANTES

This portable luminaire has a polarized plug (one blade is wider than the other) as a feature to reduce the risk of electric shock. This plug will fit in a polarized outlet only one way. If the plug does not fit fully in the outlet, reverse the plug. If it still does not fit, contact a qualified electrician. Never use with an extension cord unless plug can be fully inserted. Do not alter the plug. Ce luminaire portable a un bouchon polarisé (une lame est plus large que l'autre) pour réduire le risque de choc électrique. Ce bouchon ne tiendra dans une prise polarisée qu'une seule façon. Si la prise ne rentre pas complètement dans la prise, inversez la prise. Si elle ne rentre toujours pas, contactez un électricien qualifié. Ne jamais utiliser avec une rallonge à moins que la prise ne soit complètement insérée. Ne modifiez pas la prise.

WARNING AVERTISSEMENT

Deviation from the assembly instructions may result in a risk of fire or electric shock. Un écart par rapport aux instructions de montage peut entraîner un risque d'incendie ou de choc électrique. Only self-ballasted lamps that are suitable for use with lamp dimmers shall be used when replacing lamps. Lors du remplacement des feux, seuls les feux autoballastés qui peuvent être utilisés avec des variateurs doivent être utilisés.

CAUTION - RISK OF FIRE ATTENTION - RISQUE D'INCENDIE

Household use
Pour l'usage à la maison

Dry location only
Pour emplacements secs seulement

NOTE

Contact a qualified electrician if you experience any issues during installation.
The external cable cannot be replaced. If damaged, it must be replaced only by the manufacturer, their service agent or another qualified individual.

WARNING

Improper installation, adjustment, alteration, service, maintenance or use can cause personal injury or property damage.
Before installing, always turn off the power for the circuit.

CAUTION

Keep this product and its packaging out of children's reach.

DISPOSAL

At the end of its life, dispose of this lamp in the correct waste bin or at a recycling station.
Do not discard as household waste. Your local authority can provide further information on where and how it can be disposed of.

1

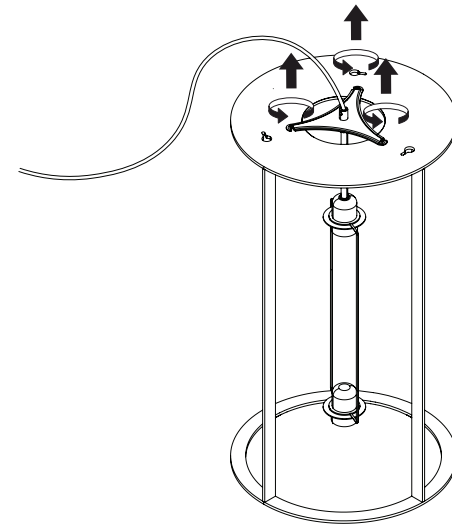

2

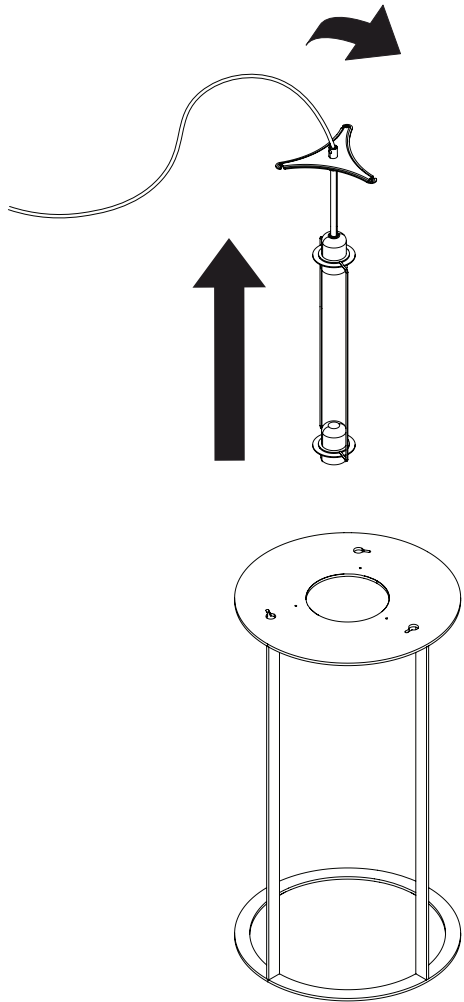

3

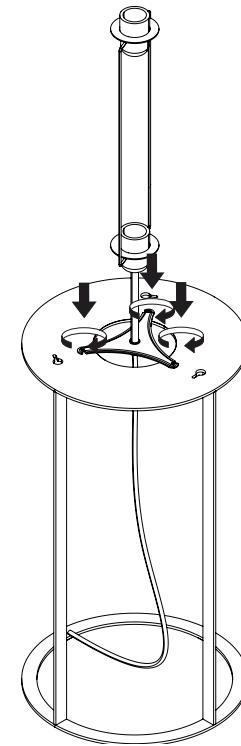

4

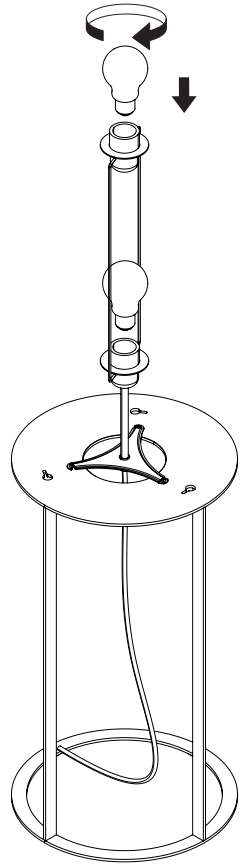

5

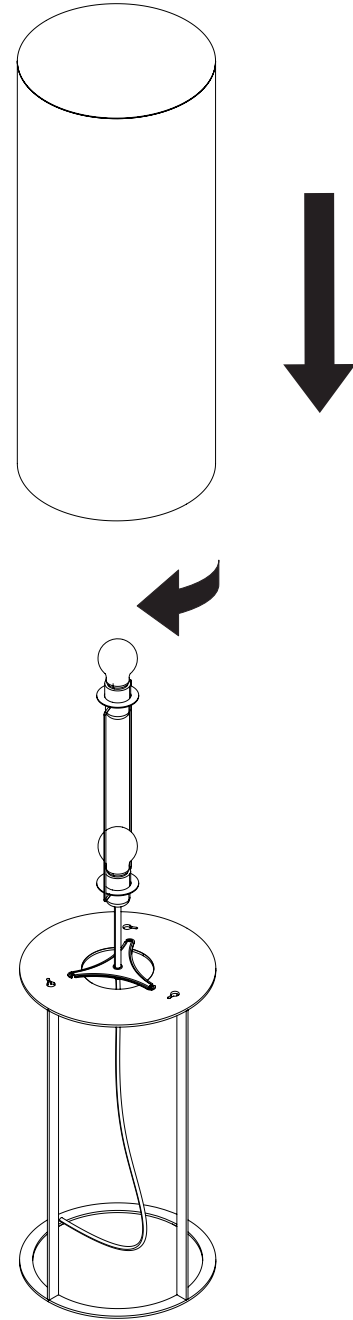

6

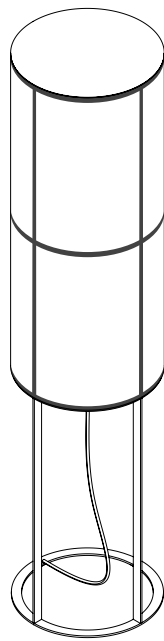
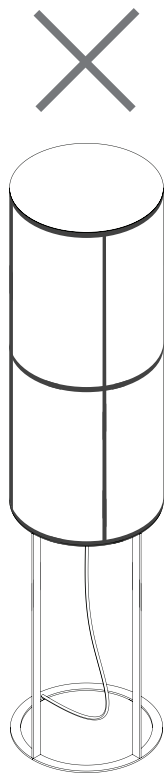
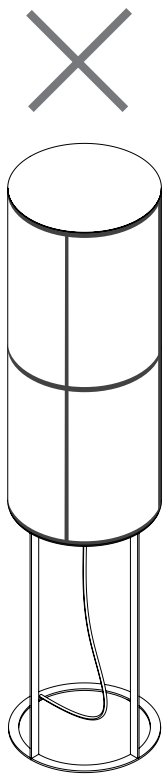

7

