

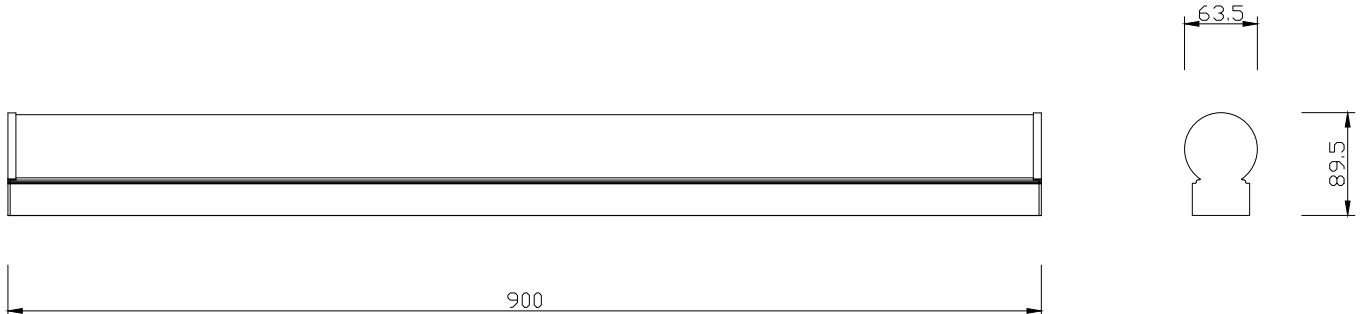



10020154

17W LED / 17W Total
incl. LED Board: L9001838
220-240V ~ 50/60Hz





Maßeinheit/Unit of measure/ Unité de mesure: mm

| (DE) Bestimmungsgemäße Verwendung | |
|--|---|
| (GB) Intended use / (FR) Utilisation conforme / (NL) Beoogd gebruik / (PL) Stosowanie zgodnie z przeznaczeniem / (NO) Riktig bruk / (DK) Korrekt brug / (SE) Avsedd användning / (FI) Määräystenmukainen käyttö / (IT) Impiego appropriato / (ES) Uso prescrito / (CZ) Použití v souladu s určením / (PT) Utilização correta / (GR) Ενδεδειγμένη χρήση | |
| (DE) Ortsfeste Verwendung als Wandleuchte im Innenbereich | (GB) Provided for stationary use on walls, indoors |
| (FR) Installation fixe en tant qu'applique, à l'intérieur | (NL) Vast gebruik als wandlamp binnenshuis |
| (PL) Do montażu stacjonarnego jako lampa ścienna do wnetrz | (NO) Til stasjonært bruk som veggglampe innendørs |
| (DK) Til stationær brug som væglampe indendørs | (SE) Används som fast väggglampa inomhus |
| (FI) Kiinteä käyttö sisätilojen seinävalaisimena | (IT) Impiego fisso come applique in ambienti interni |
| (ES) Empleo fijo en tanto lámpara de pared en interiores | (CZ) Stacionární použití jako nástěnné svítidlo v interiéru |
| (PT) Aplicação fixa como luminária de parede em interiores | (GR) Σταθερή χρήση ως φωτιστικό τοίχου σε εσωτερικό χώρο |

| (DE) Verwendete Symbole | |
|---|--|
| (GB) Safety Precautions / (FR) Symboles utilisés / (NL) Gebruikte symbolen / (PL) Stosowane symbole / (NO) Brukte symboler / (DK) Brugte symboler / (SE) Använda symboler / (FI) Käytetyt symbolit / (IT) Simboli usati / (ES) Símbolos empleados / (CZ) Použité symboly / (PT) Símbolos utilizados / (GR) Χρησιμοποιούμενα σύμβολα | |
| IP 44     | |

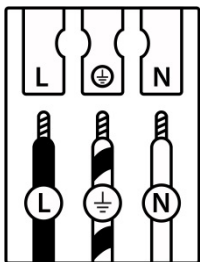
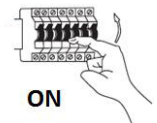
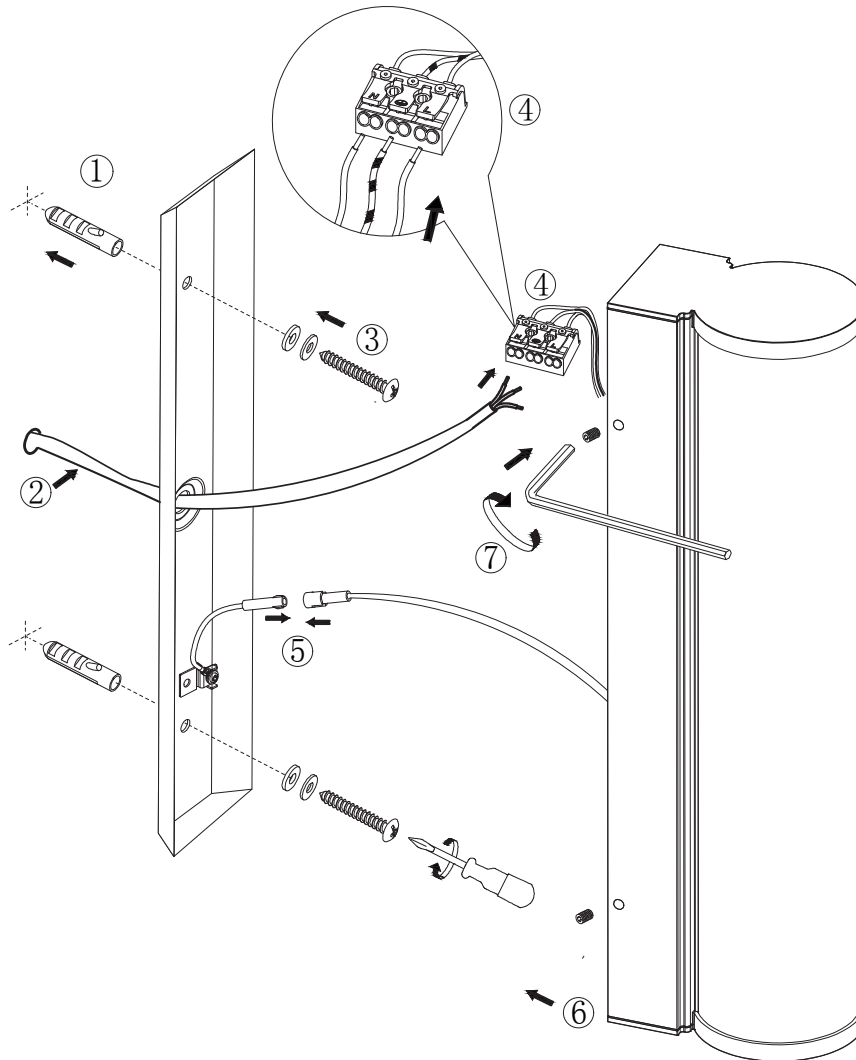
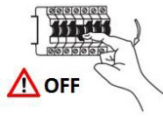
| (DE) Lieferumfang | | |
|---|--|--|
| (GB) Package contents / (FR) Contenu de la livraison / (NL) Bij de levering inbegrepen / (PL) Zakres dostawy / (NO) Levering / (DK) Leveringsomfang / (SE) Leveransomfattning / (FI) Toimitussisältö / (IT) Fornitura / (ES) Volumen de suministro / (CZ) Rozsah dodávky / (PT) Material fornecido / (GR) Παραδοτέος εξοπλισμός | | |
| (DE) 1 Wandleuchte Montagematerial Montageanleitung | (GB) 1 Wall light Installation hardware Mounting instructions | (FR) 1 Applique Matériel de montage Instructions de montage |
| (NL) 1 Wandlamp Monteringsmateriale Montagehandleiding | (PL) 1 Lampa ścienna Elementy montażowe Instrukcja montażu | (NO) 1 Veggglampe Monteringsmateriale Brukerveiledning |
| (DK) 1 Væglampe Monteringsmateriale Brugervejledning | (SE) 1 Väggglampa Monteringsmaterial Monteringsanvisning | (FI) 1 Seinävalaisin Asennusmateriaali Asennusohjeet |
| (IT) 1 Applique Materiale di montaggio Istruzioni di montaggio | (ES) 1 Lámpara de pared Material de montaje Instrucciones de montaje | (CZ) 1 Nástěnné svítidlo Materiál pro montáž Návod k montáži |
| (PT) 1 Luminária de parede Material de montagem Instruções de montagem | (GR) 1 Φωτιστικό τοίχου Υλικά συναρμολόγησης Οδηγίες συναρμολόγησης | |



| | (DE) | (GB) | (FR) | (NL) | (PL) | (NO) | (DK) |
|---|-----------------------|-------------------|----------------------------------|------------------------|---------------------|--------------------|--------------------|
| L | Stromführender Leiter | Live conductor | Conducteur | Spanningvoerende draad | Przewód prądowy | Strømførende leder | Strømførende leder |
|  | Schutzleiter | Earth conductor | Conducteur de protection (terre) | Aardkabel | Przewód uziemiający | Jordledningen | Jordledningen |
| N | Neutralleiter | Neutral conductor | Conducteur neutre | Nulleider | Przewód zerowy | Nøytralleder | Neutralleider |

| | (SE) | (FI) | (IT) | (ES) | (CZ) | (PT) | (GR) |
|---|---------------------|-------------|---------------------------|-------------------------|-------------------|-------------------|---------------------|
| L | Strömförande ledare | Virtajohdin | Conduttore sotto tensione | Conductor de corriente | Vodič pod napětím | Condutor vivo | Ρευματοφόρος αγωγός |
|  | Skyddsledare | Suojajohdin | Conduttore di terra | Conductor de protección | Ochranný vodič | Condutor de terra | Αγωγός γείωσης |
| N | Neutralledare | Nollajohdin | Conduttore neutro | Conductor neutro | Neutrální vodič | Condutor neutro | Ουδέτερος αγωγός |

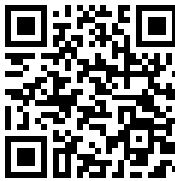
| | | |
|--|---|---------------|
| <p>(DE) Dieses Produkt enthält eine Lichtquelle der Energieeffizienzklasse E (EN) This product contains a light source of energy efficiency class E (FR) Ce produit comprend une source de lumière de classe d'efficacité énergétique E (NL) Dit product bevat een lichtbron van energie-efficiëntieklasse E (PL) Produkt ten zawiera źródło światła o klasie efektywności energetycznej E (NO) Dette produktet inneholder en lyskilde i energieeffektivitetsklasse E (DK) Dette produkt indeholder en lyskilde af energieeffektklasse E (SE) Denna produkt innehåller en ljuskälla i energieffektivitetsklass E (FI) Tämä tuote sisältää energiatehokkuusluokan E valonlähteen (IT) Questo prodotto contiene una sorgente luminosa della classe di efficienza energetica E (ES) Este producto contiene una fuente de luz de la clase de eficiencia energética E (CZ) Tento výrobek obsahuje světelný zdroj třídy energetické účinnosti E (PT) Este produto contém uma fonte de luz da classe de eficiência energética E (GR) Αυτό το προϊόν περιέχει μια φωτεινή πηγή ενεργειακής απόδοσης κλάσης E (SK) Tento výrobok obsahuje zdroj svetla triedy energetickej efektivity E</p> | QR | EAN |
| |  | 4251911729856 |

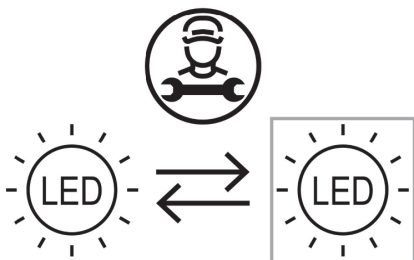
| | |
|--|--|
|  | <p>(DE) Durch einen Fachmann austauschbare Lichtquelle (nur LED). (EN) Replaceable (LED only) light source by a professional. (FR) Source de lumière remplaçable (LED uniquement) par un professionnel. (NL) Lichtbron (alleen led) te vervangen door een professional. (PL) Wymienne (tylko LED) źródło światła wykonane przez profesjonalistę. (NO) Utskiftbar (kun LED) lyskilde av en profesjonell. (DK) Udskiftelig lyskilde (kun LED), udskiftes af en elektriker. (SE) Ljuskälla (endast LED) utbytbar genom fackman. (FI) Ammattilainen voi vaihtaa vaihdettavan (vain LED) valonlähteen. (IT) Sorgente luminosa (solo LED) sostituibile da un professionista. (ES) Fuente de luz (solo LED) sustituible por un profesional. (CZ) Vyměnitelný (pouze LED) světelný zdroj odborníkem. (PT) Luz LED (apenas LED) substituível por um profissional. (GR) Η πηγή φωτός (μόνο LED) να αντικαθίσταται από επαγγελματία. (SK) Zdroj svetla (iba LED) vymeniteľný prostredníctvom odborníka.</p> |
|--|--|

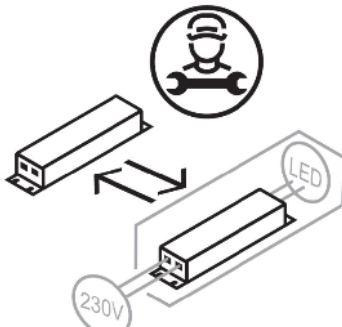
| | |
|---|--|
|  | <p>(DE) Durch einen Fachmann austauschbares Betriebsgerät. (EN) Replaceable control gear by a professional. (FR) Contrôleur remplaçable par un professionnel. (NL) Voorschakelapparatuur te vervangen door een professional. (PL) Wymienny układ sterujący przez profesjonalistę. (NO) Utskiftbar kontrollutstyr av en profesjonell. (DK) Udskiftelig igangsætter, udskiftes af en elektriker. (SE) Styrdon utbytbar genom fackman. (FI) Ammattilainen voi vaihtaa vaihdettavat ohjauslaitteet. (IT) Dispositivo di controllo sostituibile da un professionista. (ES) Dispositivo de control sustituible por un profesional. (CZ) Vyměnitelný předřadník odborníkem. (PT) Dispositivo de controlo substituível por um profissional. (GR) Ο εξοπλισμός ελέγχου να αντικαθίσταται από επαγγελματία. (SK) Predradník vymeniteľný prostredníctvom odborníka.</p> |
|---|--|