





Mounting instruction

7606-000/7608-000

- 4 x 
- 4 x 
- 2 x 
- 2 x 

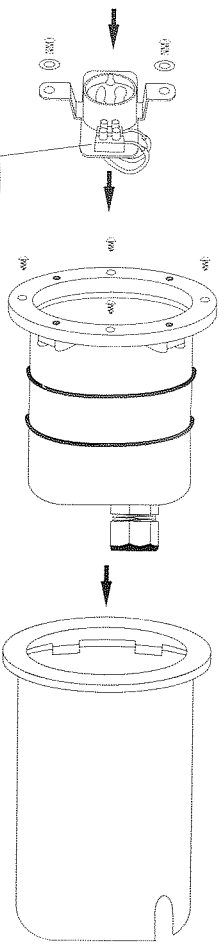
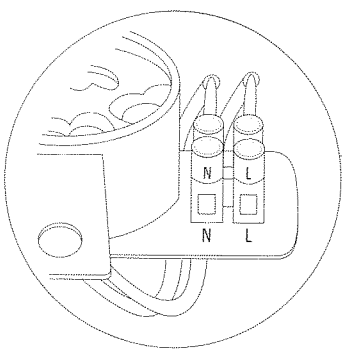
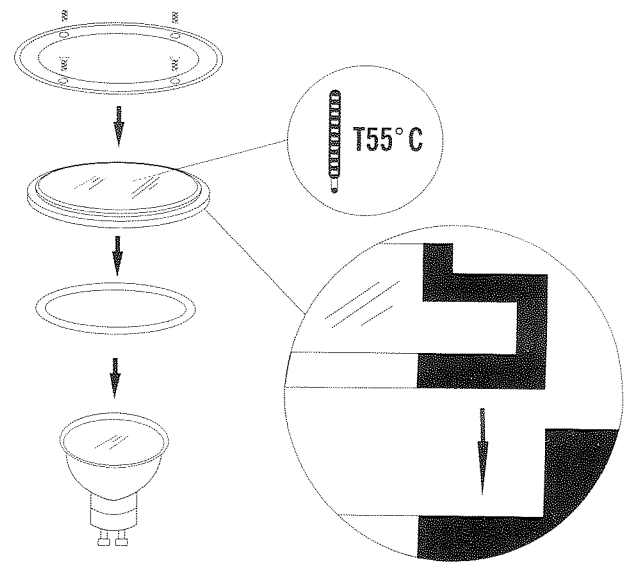

SE: Får endast installeras av behörig elektriker.
 GB: The light fitting must be installed by a qualified electrician.
 DE: Die Leuchte ist von einem qualifizierten Elektriker zu installieren.
 NL: De armatuur moet geïnstalleerd worden door een erkend elektricien.
 FI: Valaisimen saa asentaa vain ammattitaitoinen sähkömiehes.
 F: L'armature doit être installée par un électricien professionnel.
 I: L'armatura dev'essere installata da un elettricista qualificato.
 DK: Armaturet skal installeres af en autoriseret elektriker.
 N: Kan kun monteres av autorisert installatør.
 CZ: Smí být instalováno pouze zkoušeným elektrikářem.
 PL: Instalacja powinna być wykonana przez kwalifikowanego elektryka.
 E: La instalación tiene que hacerse por un electricista.

