

Instructions

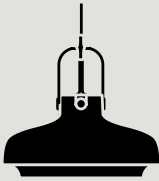

Copenhagen SC8 Space Copenhagen 2014

Congratulations with your new Copenhagen lamp, designed in 2014 by Space Copenhagen. We hope you will enjoy using this product and follow these instructions to ensure correct installation. If you have any questions or comments, please do not hesitate to contact us by mail on:

info@andtradition.com

Copenhagen SC8 Space Copenhagen 2014

Please read these instructions carefully and retain them for future reference to ensure that the product is used correctly. For your own safety, please study each step of this instruction manual first. &Tradition is not responsible for any faults or damages caused by not following these instructions correctly. Do not modify this product in any way.

Contents

- A Shade
- B Canopy with metal ceiling bracket

Tools needed

- Bulb type E27
- Small flat-head screwdriver for wiring

Safety precautions

- Dispose of plastic bag from packaging and do not allow children to play with it.
- Keep product well out of children's reach.
- The lamp is only intended for interior use.
- Consult a professionally qualified electrician if in any doubt.
- Disconnect the electricity supply at the fuse box, before commencing work.

Cleaning instructions

- Wipe surface of the shade with a soft, damp sponge or cloth, and wipe immediately after with a dry cloth.
- Do not use any abrasive cleaning tools such as steel wool, scouring sponges or stiff brushes.
- Never use strong cleaning agents such as white spirit, turpentine, household glass cleaner or cellulose thinners.
- Only wipe the inside of the shade with a soft, damp cloth or feather duster.

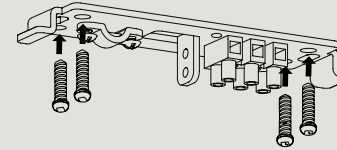
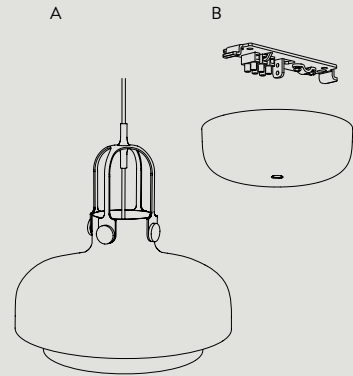

Step 1

Ensure power supply is turned off and remove any existing lamp fitting. Locate the supply cable and ensure it is ready to be fitted to the connector block.

Mount the metal bracket (B) securely in the ceiling with screws and wall plugs, appropriate for the ceiling of installation.

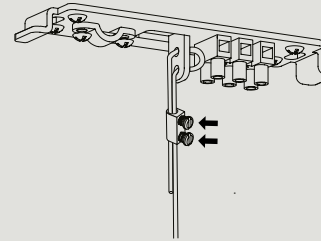

Step 2

To determine the right suspension height for the lamp, pass the safety wire through the the metal bracket, find the desired height and make sure that the safety wire is blocked with the two screws. The excess wire can be cut after assuring the safety wire is blocked.

Pass the electrical cable through the metal bracket and tighten the two screws to secure it.

The safety wire must always be shorter than the electrical cable during and after installation.

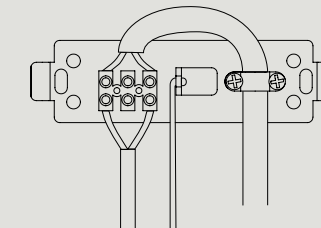
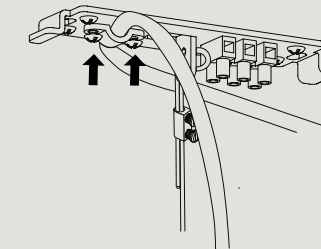

Step 3

Use the terminal box to assemble the wires from the pendant with the wires from the power supply.

For indoor use only
E27 maximum 150W
Bulb not included

UK CE IP20

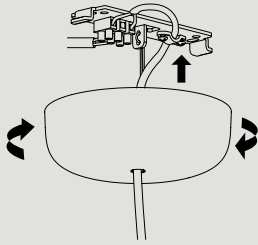

Step 4

Install the plastic canopy onto the metal bracket

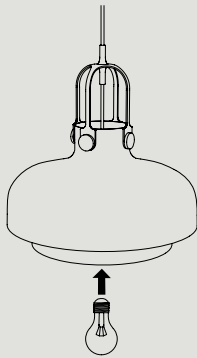

Step 5

Install light bulb.