

# SLATE



18/2037.xx

18/2038.xx

18/2039.xx

18/2040.xx

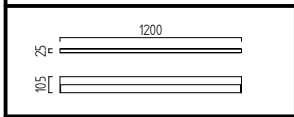
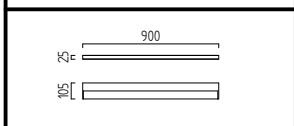
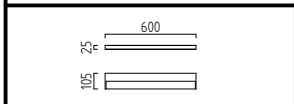
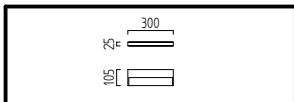
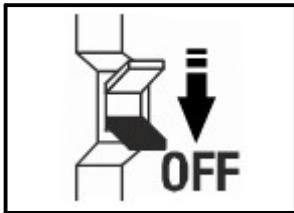
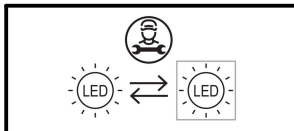
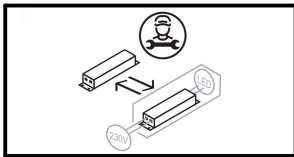

L=	18/2037	250mm
	18/2038	530mm
	18/2039	830mm
	18/2040	1130mm

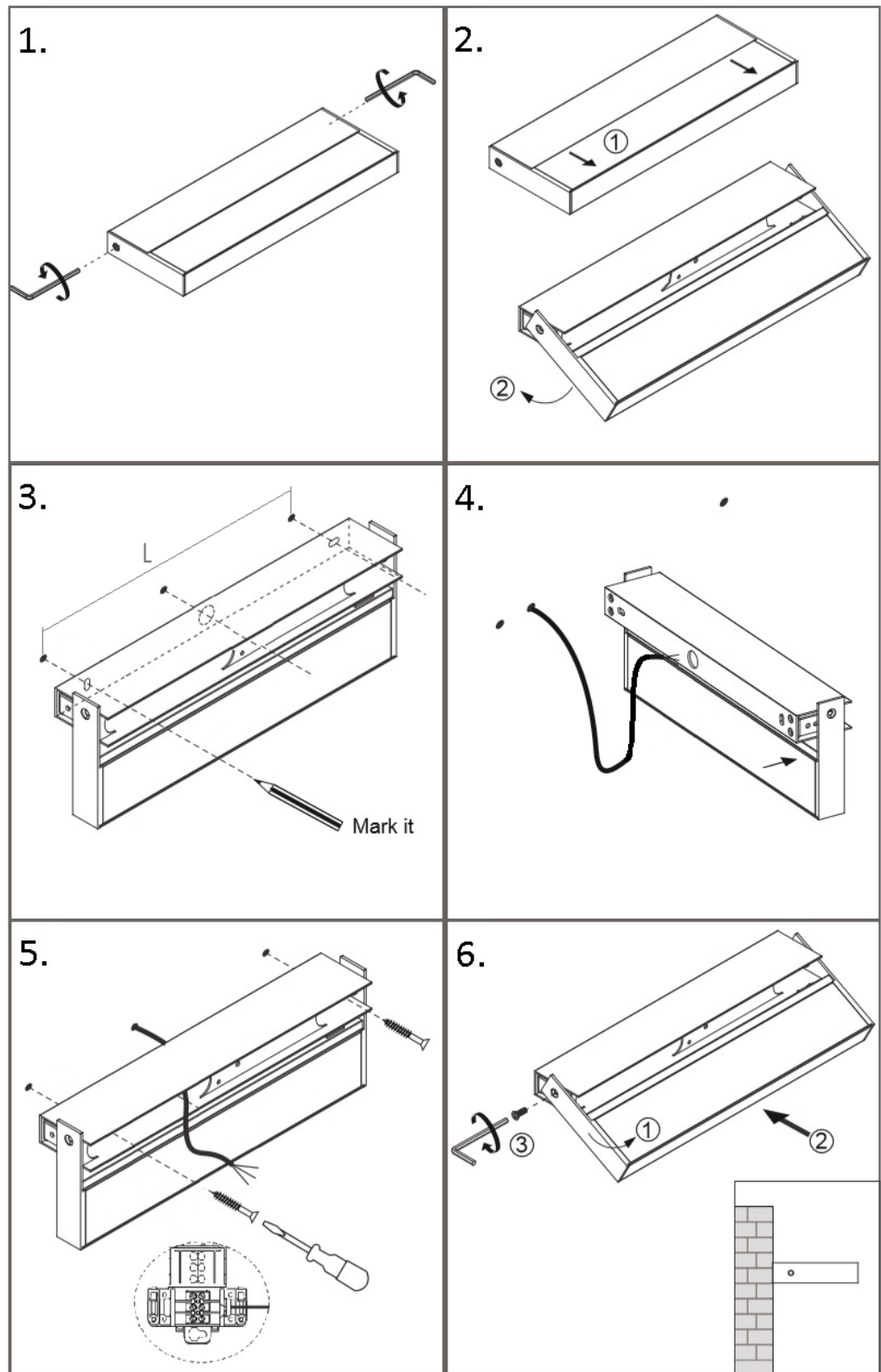

Bitte beachten Sie unsere allgemeinen Hinweise !  
 Please observe our general information !  
 Nous vous prions d'observer nos instructions générales !  
 Observen por favor nuestra información general !

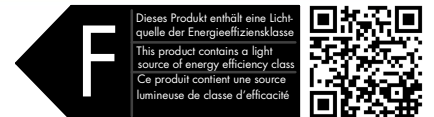

[www.helestra.de/installation](http://www.helestra.de/installation)

**Helestra Leuchten GmbH**

An den Breiten 7, 01454 Leppersdorf, Deutschland/Germany

[www.helestra.de](http://www.helestra.de)