

# 9627423

## 23W LED

### Incl. LED Board: L9001857

### 230V ~ 50Hz



#### (DE) Bestimmungsgemäße Verwendung

(GB) Intended use / (FR) Utilisation conforme / (NL) Beoogd gebruik / (PL) Stosowanie zgodnie z przeznaczeniem / (NO) Riktig bruk / (DK) Korrekt brug / (SE) Avsedd användning / (FI) Määräystenmukainen käyttö / (IT) Impiego appropriato / (ES) Uso prescrito / (CZ) Použití v souladu s určením / (PT) Utilização correta / (GR) Ενδειγμένη χρήση

|      |   |      |  |
|------|---|------|--|
| (DE) | Ortsfeste Verwendung als Hängeleuchte im Innenbereich       | (GB) | Provided for stationary indoor use as pendant light          |
| (FR) | Utilisation stationnaire en tant que suspension d'intérieur | (NL) | Vast gebruik als hanglamp binnenshuis                        |
| (PL) | Do montażu stacjonarnego jako lampa wisząca do wnętrza      | (NO) | Til stasjonært bruk som pendellampe innendørs                |
| (DK) | Til stationær brug som pendellampe indendørs                | (SE) | Används som fast hänglampa inomhus                           |
| (FI) | Kiinteä käyttö sisätilojen riippuvalaisimena                | (IT) | Impiego fisso come lampada a sospensione in ambienti interni |
| (ES) | Empleo fijo en tanto lámpara colgante en interiores         | (CZ) | Stacionární použití jako závěsné svítidlo v interiéru        |
| (PT) | Aplicação fixa como candeeiro suspenso em interiores        | (GR) | Σταθερή χρήση ως κρεμαστό φωτιστικό σε εσωτερικό χώρο        |

#### (DE) Verwendete Symbole

(GB) Safety Precautions / (FR) Symboles utilises / (NL) Gebruikte symbolen / (PL) Stosowane symbole / (NO) Brukte symboler / (DK) Brugte symboler / (SE) Använda symboler / (FI) Käytetyt symbolit / (IT) Simboli usati / (ES) Símbolos empleados / (CZ) Použité symboly / (PT) Símbolos utilizados / (GR) Χρησιμοποιούμενα σύμβολα

IP 20



#### (DE) Lieferumfang

(GB) Package contents / (FR) Contenu de la livraison / (NL) Bij de levering inbegrepen / (PL) Zakres dostawy / (NO) Levering / (DK) Leveringsomfang / (SE) Leveransomfattning / (FI) Toimitussisältö / (IT) Fornitura / (ES) Volumen de suministro / (CZ) Rozsah dodávky / (PT) Material fornecido / (GR) Παραδοτέος εξοπλισμός

|      |  |      |  |      |  |
|------|--|------|--|------|--|
| (DE) | 1 Hängeleuchte<br>Montagematerial<br>Montageanleitung                        | (GB) | 1 Pendant light<br>Installation hardware<br>Mounting instructions      | (FR) | 1 Suspension<br>Matériel de montage<br>Instructions de montage |
| (NL) | 1 Hanglamp<br>Monteringsmateriale<br>Montagehandleiding                      | (PL) | 1 Lampa wisząca<br>Elementy montażowe<br>Instrukcja montażu            | (NO) | 1 Pendellampe<br>Monteringsmateriale<br>Brukerveiledning       |
| (DK) | 1 Pendellampe<br>Monteringsmateriale<br>Brugervejledning                     | (SE) | 1 Hänglampa<br>Monteringsmaterial<br>Monteringsanvisning               | (FI) | 1 Riippuvalaisin<br>Asennusmateriaali<br>Asennusohjeet         |
| (IT) | 1 Lampada a sospensione<br>Materiale di montaggio<br>Istruzioni di montaggio | (ES) | 1 Lámpara colgante<br>Material de montaje<br>Instrucciones de montaje  | (CZ) | 1 Závěsné svítidlo<br>Materiál pro montáž<br>Návod k montáži   |
| (PT) | 1 Candeeiro suspenso<br>Material de montagem<br>Instruções de montagem       | (GR) | 1 Κρεμαστό φωτιστικό<br>Υλικά συναρμολόγησης<br>Οδηγίες συναρμολόγησης |      |  |

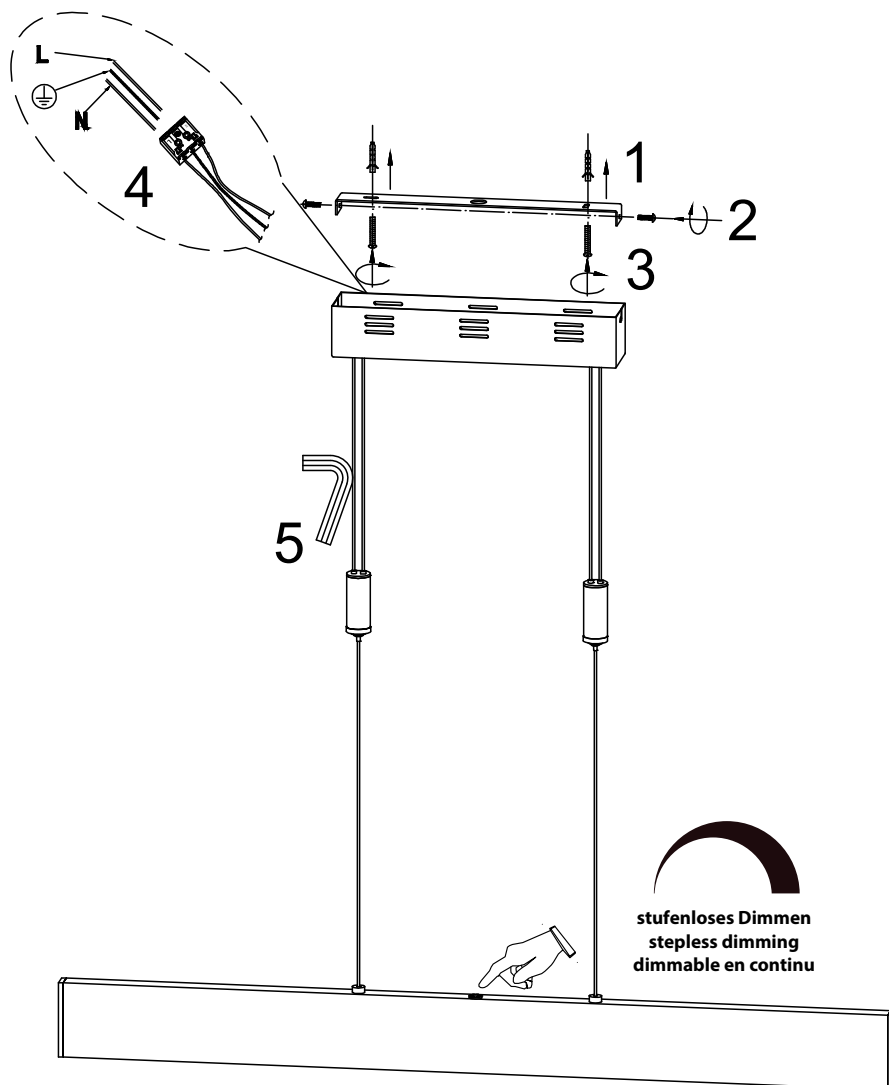
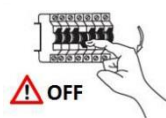

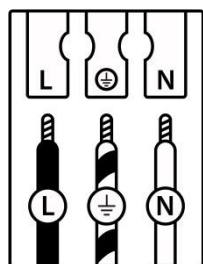
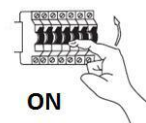

  
**stufenloses Dimmen**  
**stepless dimming**  
**dimmable en continu**



|   | (DE)                  | (GB)              | (FR)                             | (NL)                   | (PL)                | (NO)               | (DK)               |
|---|-----------------------|-------------------|----------------------------------|------------------------|---------------------|--------------------|--------------------|
| <b>L</b>  | Stromführender Leiter | Live conductor    | Conducteur                       | Spanningvoerende draad | Przewód prądowy     | Strømførende leder | Strømførende leder |
|  | Schutzleiter          | Earth conductor   | Conducteur de protection (terre) | Aardkabel              | Przewód uziemiający | Jordledningen      | Jordledningen      |
| <b>N</b>  | Neutralleiter         | Neutral conductor | Conducteur neutre                | Nulleider              | Przewód zerowy      | Nøytralleder       | Neutrallerder      |

|   | (SE)                | (FI)        | (IT)                      | (ES)                            | (CZ)              | (PT)              | (GR)                |
|---|---------------------|-------------|---------------------------|---------------------------------|-------------------|-------------------|---------------------|
| <b>L</b>  | Strömförande ledare | Virtajohdin | Conduttore sotto tensione | Líneas conductoras de corriente | Vodič pod napětím | Condutor vivo     | Ρευματοφόρος αγωγός |
|  | Skyddsledare        | Suojajohdin | Conduttore di terra       | Conductor de protección         | Ochranný vodič    | Condutor de terra | Αγωγός γείωσης      |
| <b>N</b>  | Neutralledare       | Nollajohdin | Conduttore neutro         | Conductor neutro                | Neutrální vodič   | Condutor neutro   | Ουδέτερος αγωγός    |

|   |  |  |
|---|--|--|
| <p><b>(DE)</b> Dieses Produkt enthält eine Lichtquelle der Energieeffizienzklasse E<br/> <b>(EN)</b> This product contains a light source of energy efficiency class E<br/> <b>(FR)</b> Ce produit comprend une source de lumière de classe d'efficacité énergétique E<br/> <b>(NL)</b> Dit product bevat een lichtbron van energie-efficiëntieklasse E<br/> <b>(PL)</b> Produkt ten zawiera źródło światła o klasie efektywności energetycznej E<br/> <b>(NO)</b> Dette produktet inneholder en lyskilde i energieeffektivitetsklasse E<br/> <b>(DK)</b> Dette produkt indeholder en lyskilde af energieeffektklasse E<br/> <b>(SE)</b> Denna produkt innehåller en ljuskälla i energieffektivitetsklass E<br/> <b>(FI)</b> Tämä tuote sisältää energiatehokkuusluokan E valonlähteen<br/> <b>(IT)</b> Questo prodotto contiene una sorgente luminosa della classe di efficienza energetica E<br/> <b>(ES)</b> Este producto contiene una fuente de luz de la clase de eficiencia energética E<br/> <b>(CZ)</b> Tento výrobek obsahuje světelný zdroj třídy energetické účinnosti E<br/> <b>(PT)</b> Este produto contém uma fonte de luz da classe de eficiência energética E<br/> <b>(GR)</b> Αυτό το προϊόν περιέχει μια φωτεινή πηγή ενεργειακής απόδοσης κλάσης E<br/> <b>(SK)</b> Tento výrobok obsahuje zdroj svetla triedy energetickej efektivity E</p> | <p style="text-align: center;"><b>QR</b></p>  | <p style="text-align: center;"><b>EAN</b></p> <p style="text-align: center;">4251911730289</p> |
|---|--|--|

|  |  |
|--|--|
|  | <p><b>(DE)</b> Durch einen Fachmann austauschbare Lichtquelle (nur LED)<br/> <b>(EN)</b> Replaceable (LED only) light source by a professional.<br/> <b>(FR)</b> Source de lumière remplaçable (LED uniquement) par un professionnel.<br/> <b>(NL)</b> Lichtbron (alleen led) te vervangen door een professional.<br/> <b>(PL)</b> Wymienne (tylko LED) źródło światła wykonane przez profesjonalistę.<br/> <b>(NO)</b> Utskiftbar (kun LED) lyskilde av en profesjonell.<br/> <b>(DK)</b> Udskiftelig lyskilde (kun LED), udskiftes af en elektriker.<br/> <b>(SE)</b> Ljuskälla (endast LED) utbytbar genom fackman.<br/> <b>(FI)</b> Ammattilainen voi vaihtaa vaihdettavan (vain LED) valonlähteen.<br/> <b>(IT)</b> Sorgente luminosa (solo LED) sostituibile da un professionista.<br/> <b>(ES)</b> Fuente de luz (solo LED) sustituible por un profesional.<br/> <b>(CZ)</b> Vyměnitelný (pouze LED) světelný zdroj odborníkem.<br/> <b>(PT)</b> Luz LED (apenas LED) substituível por um profissional.<br/> <b>(GR)</b> Η πηγή φωτός (μόνο LED) να αντικαθίσταται από επαγγελματία.<br/> <b>(SK)</b> Zdroj svetla (iba LED) vymeniteľný prostredníctvom odborníka.</p> |
|--|--|

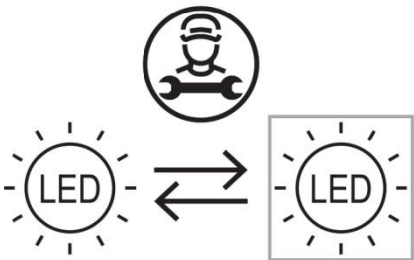
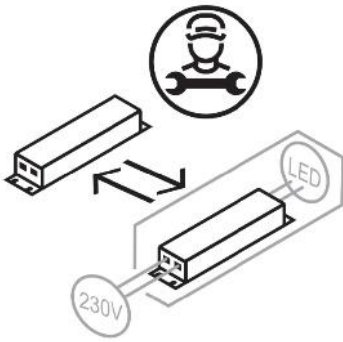
|   |   |
|---|---|
|  | <p><b>(DE)</b> Durch einen Fachmann austauschbares Betriebsgerät.<br/> <b>(EN)</b> Replaceable control gear by a professional.<br/> <b>(FR)</b> Contrôleur remplaçable par un professionnel.<br/> <b>(NL)</b> Voorschakelapparatuur te vervangen door een professional.<br/> <b>(PL)</b> Wymienny układ sterujący przez profesjonalistę.<br/> <b>(NO)</b> Utskiftbar kontrollutstyr av en profesjonell.<br/> <b>(DK)</b> Udskiftelig igangsætter, udskiftes af en elektriker.<br/> <b>(SE)</b> Styrdon utbytbar genom fackman.<br/> <b>(FI)</b> Ammattilainen voi vaihtaa vaihdettavat ohjauslaitteet.<br/> <b>(IT)</b> Dispositivo di controllo sostituibile da un professionista.<br/> <b>(ES)</b> Dispositivo de control sustituible por un profesional.<br/> <b>(CZ)</b> Vyměnitelný předřadník odborníkem.<br/> <b>(PT)</b> Dispositivo de controlo substituível por um profissional.<br/> <b>(GR)</b> Ο εξοπλισμός ελέγχου να αντικαθίσταται από επαγγελματία.<br/> <b>(SK)</b> Predradník vymeniteľný prostredníctvom odborníka.</p> |
|---|---|