

CALEX
H O L L A N D

SMART  OUTDOOR



EN - This manual, **A**, contains descriptions of all necessary steps for assembling and installing this product. Refer to the icons in the supplementary manual, **B**, to see which of the following points apply to this product:

NL - Deze handleiding, **A**, bevat beschrijvingen van alle noodzakelijke stappen voor het monteren en installeren van dit product. Raadpleeg de pictogrammen in de aanvullende handleiding, **B**, om te zien welke van de volgende punten van toepassing zijn op dit product:

DE - Dieses Handbuch **A**, enthält Beschreibungen aller erforderlichen Schritte zum Zusammenbau und zur Installation dieses Produkts. Beziehen Sie sich auf die Symbole im Zusatzhandbuch **B**, um zu sehen, welche der folgenden Punkte für dieses Produkt gelten:

FR - Ce manuel, **A**, contient des descriptions de toutes les étapes nécessaires à l'assemblage et à l'installation de ce produit. Reportez-vous aux icônes du manuel supplémentaire, **B**, pour voir lequel des points suivants s'applique à ce produit:

PL - Niniejsza instrukcja, **A**, zawiera opisy wszystkich kroków niezbędnych do montażu i instalacji tego produktu. Zapoznaj się z ikonami w dodatkowej instrukcji, **B**, aby zobaczyć, które z poniższych punktów dotyczą tego produktu:

CS - Tato příručka **A**, obsahuje popis všech kroků nezbytných pro sestavení a instalaci tohoto produktu. Podle ikon v doplňkové příručce **B**, zjistíte, které z následujících bodů se vztahují na tento produkt:

IT - Questo manuale, **A**, contiene le descrizioni di tutti i passaggi necessari per l'assemblaggio e l'installazione di questo prodotto. Fare riferimento alle icone nel manuale supplementare, **B**, per vedere quale dei seguenti punti si applica a questo prodotto:

SK - Táto príručka **A**, obsahuje popis všetkých krokov potrebných na zostavenie a inštaláciu tohto produktu. Na ikonách v doplnkovej príručke **B**, sa dozviete, ktoré z nasledujúcich bodov sa na tento výrobok vzťahujú:

ES - Este manual, **A**, contiene descripciones de todos los pasos necesarios para ensamblar e instalar este producto. Consulte los iconos del manual complementario, **B**, para ver cuál de los siguientes puntos se aplica a este producto:

PT - Este manual, **A**, contém descrições de todas as etapas necessárias para a montagem e instalação deste produto. Consulte os ícones no manual suplementar, **B**, para ver quais dos seguintes pontos se aplicam a este produto:

RO - Acest manual, **A**, conține descrieri ale tuturor etapelor necesare pentru asamblarea și instalarea acestui produs. Consultați pictogramele din manualul suplimentar, **B**, pentru a vedea care dintre următoarele puncte se aplică acestui produs:

NO - Denne håndboken, **A**, inneholder beskrivelser av alle nødvendige trinn for å montere og installere dette produktet. Se ikonene i tilleggshåndboken **B**, for å se hvilke av de følgende punktene som gjelder for dette produktet:

SV - Denna handbok, **A**, innehåller beskrivningar av alla nödvändiga steg för montering och installation av denna produkt. Se ikonerna i tillägghandboken **B**, för att se vilken av följande punkter som gäller för denna produkt:

FI - Tämä käsikirja **A**, sisältää kuvaukset kaikista tarvittavista vaiheista tämän tuotteen kokoamiseen ja asentamiseen. Katso lisäoppaan **B**, kuvakkeista, mitkä seuraavista kohdista koskevat tätä tuotetta:

DA - Denne manual, **A**, indeholder beskrivelser af alle nødvendige trin til samling og installation af dette produkt. Se ikonerne i den supplerende manual, **B**, for at se, hvilke af følgende punkter der gælder for dette produkt:

**01, 02, 04, 05, 07, 10, 14, 16 (IP44), 18, 30, 32, 33,
34, 35, 36, 37**



6 x



6 x

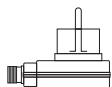

1 x



3 x



1 x



3 x



3 x



3 x

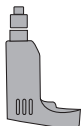
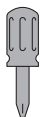

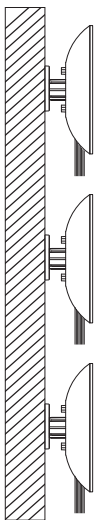
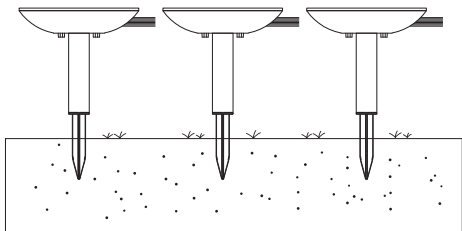
A**B**

A

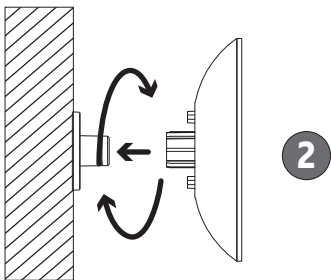
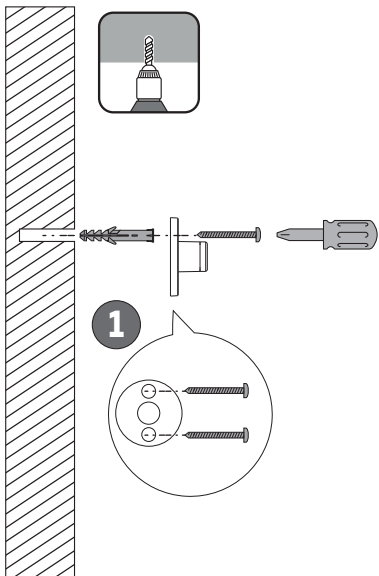

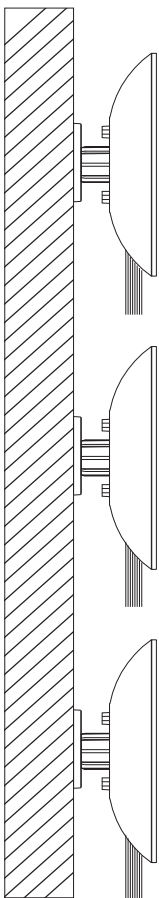

3

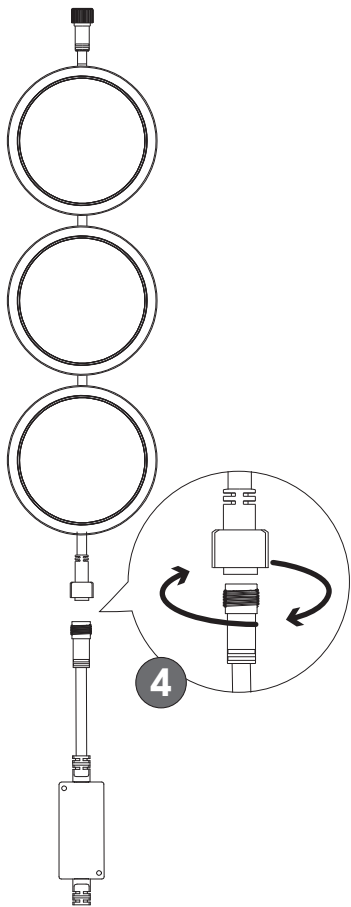

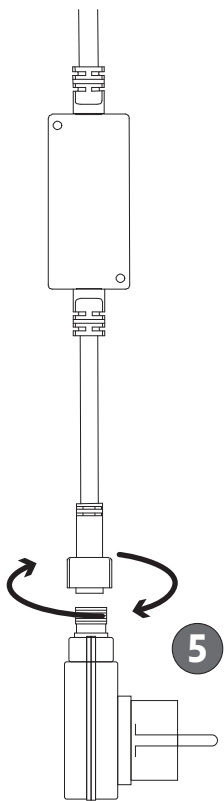

B

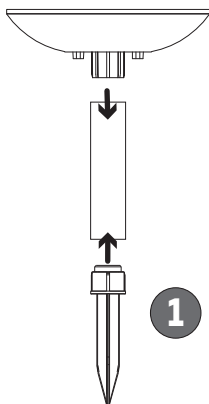

2

