

IT

1 - Seguire attentamente le istruzioni di montaggio e d'uso per garantirne un funzionamento corretto e sicuro dell'apparecchio.

2 - Conservare le Istruzioni per futura necessità. Per eventuali problemi contattare il rivenditore.

3 - Il prodotto non deve essere modificato. Qualsiasi modifica annulla le approvazioni di sicurezza e può rendere pericoloso l'apparecchio.

4 - Rotaliana declina ogni responsabilità per danni causati a cose o a persone da un non corretto uso dell'apparecchio.

5 - Fare riferimento al sito web www.rotaliana.it per le istruzioni di disassemblaggio a fine vita del prodotto.

EN

1 - Follow carefully the assembly and use Instructions to guarantee a correct and safe function of the luminaire.

2 - Keep the instructions for future needs. For any problems, get in touch with your supplier.

3 - The product must not be modified. Any change will nullify the safety guarantees and may make the luminaire dangerous.

4 - Rotaliana declines all responsibility for damage caused to things or persons by any improper use of the luminaire.

5 - Refer to the website www.rotaliana.it for instruction on how to disassemble the product at the end of its lifecycle.

FR

1 - Suivre soigneusement les instructions de montage et utilisation pour garantir un correct et sûr fonctionnement de l'appareil.

2 - Garder les Instructions pour des futures nécessités. Pour tous problèmes, contacter le revendeur.

3 - Le produit ne doit pas être modifié. Toute modification annule les approbations de sécurité et peut rendre dangereux l'appareil.

4 - Rotaliana décline toute responsabilité pour les dégats causés par des personnes à un incorrect usage de l'appareil.

5 - Reportez-vous au site www.rotaliana.it pour les instructions de le démontage du produit en fin de vie.

DE

1 - Bitte lesen Sie die Montage-und Gebrauchsanleitungen aufmerksam, um eine richtige und gefahrlose Arbeitsweise der Leuchte zu gewährleisten.

2 - Bewahren Sie die Anweisungen für zukünftige Notfälle auf.

3 - Das Produkt darf nicht verändert werden. Jede Änderung annulliert die Sicherheitsbestimmungen und könnte zu einer Gefährdung durch die Leuchte führen.

4 - Rotaliana ist nicht für Schäden verantwortlich, die durch Dritte bei unsachgemäßer Anwendung der Leuchte verursacht werden.

5 - Für die Demontage am Ende der Lebensdauer des Produkts konsultieren Sie bitte die Website www.rotaliana.it.

Rotaliana srl
via Trento 115 - 117
38017 Mezzolombardo
Trento, Italia

T. +39 0461 602376
info@rotaliana.it
rotaliana.it

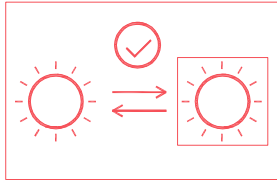

IT- Sorgente luminosa sostituibile dall'utente.

EN- Replaceable light source by an end-user.

FR- Source de lumière remplaçable par un usager final.

DE- Durch einen Endbenutzer austauschbare Lichtquelle.

A Brand of Mezzalra Investment Group
www.mig.it

Pomi design: Paolo Rizzato

Made in Italy

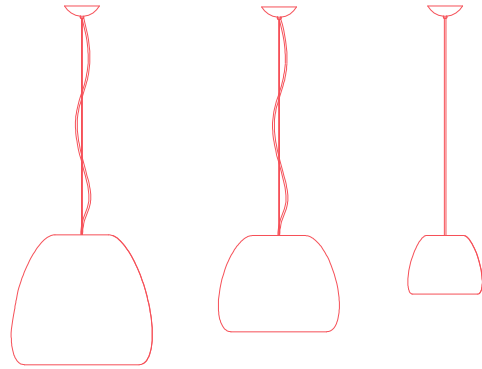

IT
EN
FR
DE
UE

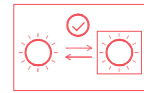
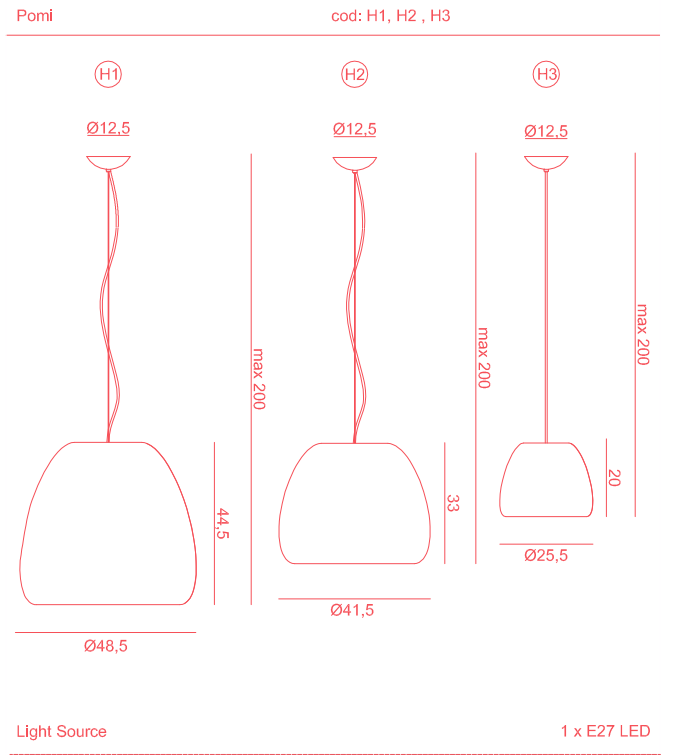

prodotti elettrici ed elettronici, locale di raccolta differenziata per pregia di Informarsi in merito al sistema quanto sopra è sanzionato dalla Legge. Si prodotto a fine vita, il mancato rispetto di di recepimento per lo smaltimento del 2012/19/UE e delle Leggi nazionali a raccolta separata per evitare danni all'ambiente. Nel rispetto della Direttiva deve essere smaltito come rifiuto urbano. Deve essere smaltito come rifiuto collettivamente separatamente da personale specializzato.

Montaggio e manutenzione devono essere eseguiti esclusivamente da personale specializzato.

ATTENZIONE L'apparecchio non deve essere smaltito come rifiuto urbano. Deve essere smaltito come rifiuto collettivamente separatamente da personale specializzato.

ATTENZIONE L'apparecchio non deve essere smaltito come rifiuto urbano. Deve essere smaltito come rifiuto collettivamente separatamente da personale specializzato.

Le parti che conducono corrente non devono entrare in contatto con l'umidità. Le superfici quali paralumi, vetri, riflettori e coperture possono essere pulite con un panno morbido senza detersivo. Proteggere la lampada dall'umidità durante l'uso.

IP20

Indice di protezione IP 20, protezione contro l'ingresso di corpi solidi di Ø 12 mm. Nessuna protezione contro la pioggia. Marcatura non prevista sull'apparecchio.

Isolamento fondamentale: collegare ad un conduttore di terra. Messa a terra obbligatoria. Isola la spina dalla presa di corrente o togliere la lampadina/struttura sempre la prima volta. Prima dell'installazione dell'apparecchio e/o sostituzione dell'apparecchio, assicurarsi che l'installazione, manutenzione e l'installazione generale dell'impianto elettrico.

Caratteristiche tecniche

Tensione di funzionamento 220 / 240 V AC 50Hz

Potenza 1 x E27 LED

IP20

Protezione against contact with solid bodies of Ø ≥ 12 mm. No protection is provided against rain. No indications are provided on the luminaire.

ATTENTION The product cannot be disposed as unsorted municipal waste. It must be collected separately to prevent negative environmental impacts. In accordance with the procedures of Directive 2012/19/UE and relevant national laws and regulations adopted pursuant to this Directive on the disposal of waste at the end of the life cycle of the product, any violation is sanctioned by law. Please inform yourself about the local separate collection system for electrical and electronic products.

Installation and maintenance must be performed exclusively by specialised personnel.

ATTENTION L'appareil ne doit pas être éliminé comme simple déchet urbain mais conformément à la Directive 2012/19/UE conformément à la Directive 2012/19/UE et aux dispositions légales qui s'appliquent pour ce qui touche à la durée de vie, les contrevenants aux dispositions en vigueur sont passibles des sanctions prévues par la loi. Veuillez vous informer du système local de séparation des déchets électriques et électroniques.

Le montage et l'entretien doivent être exclusivement réalisés par un personnel spécialisé.

ATTENTION L'appareil ne doit pas être éliminé comme simple déchet urbain mais conformément à la Directive 2012/19/UE conformément à la Directive 2012/19/UE et aux dispositions légales qui s'appliquent pour ce qui touche à la durée de vie, les contrevenants aux dispositions en vigueur sont passibles des sanctions prévues par la loi. Veuillez vous informer du système local de séparation des déchets électriques et électroniques.

Essential insulation: the accessible conductive parts are connected to an earth conductor. Grounding is mandatory.

Remove the lamp plug from its socket or turn off the lamp supply circuit, and leave the bulb to cool.

Fitting and maintaining the unit and/or replacing the bulb/LED elements conductors accessible must not be exposed to humidity. Surfaces such as lampshades, glasses, reflectors and covers can be cleaned with a soft cloth but without using detergents.

Protection level IP 20. Protection is provided against rain. No indications are provided on the luminaire.

ATTENTION The product cannot be disposed as unsorted municipal waste. It must be collected separately to prevent negative environmental impacts. In accordance with the procedures of Directive 2012/19/UE and relevant national laws and regulations adopted pursuant to this Directive on the disposal of waste at the end of the life cycle of the product, any violation is sanctioned by law. Please inform yourself about the local separate collection system for electrical and electronic products.

Installation and maintenance must be performed exclusively by specialised personnel.

ATTENTION L'appareil ne doit pas être éliminé comme simple déchet urbain mais conformément à la Directive 2012/19/UE conformément à la Directive 2012/19/UE et aux dispositions légales qui s'appliquent pour ce qui touche à la durée de vie, les contrevenants aux dispositions en vigueur sont passibles des sanctions prévues par la loi. Veuillez vous informer du système local de séparation des déchets électriques et électroniques.

Le montage et l'entretien doivent être exclusivement réalisés par un personnel spécialisé.

ATTENTION L'appareil ne doit pas être éliminé comme simple déchet urbain mais conformément à la Directive 2012/19/UE conformément à la Directive 2012/19/UE et aux dispositions légales qui s'appliquent pour ce qui touche à la durée de vie, les contrevenants aux dispositions en vigueur sont passibles des sanctions prévues par la loi. Veuillez vous informer du système local de séparation des déchets électriques et électroniques.

Essential insulation: the accessible conductive parts are connected to an earth conductor. Grounding is mandatory.

Remove the lamp plug from its socket or turn off the lamp supply circuit, and leave the bulb to cool.

Fitting and maintaining the unit and/or replacing the bulb/LED elements conductors accessible must not be exposed to humidity. Surfaces such as lampshades, glasses, reflectors and covers can be cleaned with a soft cloth but without using detergents.

Protection level IP 20. Protection is provided against rain. No indications are provided on the luminaire.

ATTENTION The product cannot be disposed as unsorted municipal waste. It must be collected separately to prevent negative environmental impacts. In accordance with the procedures of Directive 2012/19/UE and relevant national laws and regulations adopted pursuant to this Directive on the disposal of waste at the end of the life cycle of the product, any violation is sanctioned by law. Please inform yourself about the local separate collection system for electrical and electronic products.

Installation and maintenance must be performed exclusively by specialised personnel.

ATTENTION L'appareil ne doit pas être éliminé comme simple déchet urbain mais conformément à la Directive 2012/19/UE conformément à la Directive 2012/19/UE et aux dispositions légales qui s'appliquent pour ce qui touche à la durée de vie, les contrevenants aux dispositions en vigueur sont passibles des sanctions prévues par la loi. Veuillez vous informer du système local de séparation des déchets électriques et électroniques.

Essential insulation: the accessible conductive parts are connected to an earth conductor. Grounding is mandatory.

Remove the lamp plug from its socket or turn off the lamp supply circuit, and leave the bulb to cool.

Fitting and maintaining the unit and/or replacing the bulb/LED elements conductors accessible must not be exposed to humidity. Surfaces such as lampshades, glasses, reflectors and covers can be cleaned with a soft cloth but without using detergents.

Protection level IP 20. Protection is provided against rain. No indications are provided on the luminaire.

ATTENTION The product cannot be disposed as unsorted municipal waste. It must be collected separately to prevent negative environmental impacts. In accordance with the procedures of Directive 2012/19/UE and relevant national laws and regulations adopted pursuant to this Directive on the disposal of waste at the end of the life cycle of the product, any violation is sanctioned by law. Please inform yourself about the local separate collection system for electrical and electronic products.

Installation and maintenance must be performed exclusively by specialised personnel.

ATTENTION L'appareil ne doit pas être éliminé comme simple déchet urbain mais conformément à la Directive 2012/19/UE conformément à la Directive 2012/19/UE et aux dispositions légales qui s'appliquent pour ce qui touche à la durée de vie, les contrevenants aux dispositions en vigueur sont passibles des sanctions prévues par la loi. Veuillez vous informer du système local de séparation des déchets électriques et électroniques.

Essential insulation: the accessible conductive parts are connected to an earth conductor. Grounding is mandatory.

Remove the lamp plug from its socket or turn off the lamp supply circuit, and leave the bulb to cool.

Fitting and maintaining the unit and/or replacing the bulb/LED elements conductors accessible must not be exposed to humidity. Surfaces such as lampshades, glasses, reflectors and covers can be cleaned with a soft cloth but without using detergents.

Protection level IP 20. Protection is provided against rain. No indications are provided on the luminaire.

ATTENTION The product cannot be disposed as unsorted municipal waste. It must be collected separately to prevent negative environmental impacts. In accordance with the procedures of Directive 2012/19/UE and relevant national laws and regulations adopted pursuant to this Directive on the disposal of waste at the end of the life cycle of the product, any violation is sanctioned by law. Please inform yourself about the local separate collection system for electrical and electronic products.

Installation and maintenance must be performed exclusively by specialised personnel.

ATTENTION L'appareil ne doit pas être éliminé comme simple déchet urbain mais conformément à la Directive 2012/19/UE conformément à la Directive 2012/19/UE et aux dispositions légales qui s'appliquent pour ce qui touche à la durée de vie, les contrevenants aux dispositions en vigueur sont passibles des sanctions prévues par la loi. Veuillez vous informer du système local de séparation des déchets électriques et électroniques.

Essential insulation: the accessible conductive parts are connected to an earth conductor. Grounding is mandatory.

Remove the lamp plug from its socket or turn off the lamp supply circuit, and leave the bulb to cool.

Fitting and maintaining the unit and/or replacing the bulb/LED elements conductors accessible must not be exposed to humidity. Surfaces such as lampshades, glasses, reflectors and covers can be cleaned with a soft cloth but without using detergents.

Protection level IP 20. Protection is provided against rain. No indications are provided on the luminaire.

ATTENTION The product cannot be disposed as unsorted municipal waste. It must be collected separately to prevent negative environmental impacts. In accordance with the procedures of Directive 2012/19/UE and relevant national laws and regulations adopted pursuant to this Directive on the disposal of waste at the end of the life cycle of the product, any violation is sanctioned by law. Please inform yourself about the local separate collection system for electrical and electronic products.

Installation and maintenance must be performed exclusively by specialised personnel.

ATTENTION L'appareil ne doit pas être éliminé comme simple déchet urbain mais conformément à la Directive 2012/19/UE conformément à la Directive 2012/19/UE et aux dispositions légales qui s'appliquent pour ce qui touche à la durée de vie, les contrevenants aux dispositions en vigueur sont passibles des sanctions prévues par la loi. Veuillez vous informer du système local de séparation des déchets électriques et électroniques.

Essential insulation: the accessible conductive parts are connected to an earth conductor. Grounding is mandatory.

Remove the lamp plug from its socket or turn off the lamp supply circuit, and leave the bulb to cool.

Fitting and maintaining the unit and/or replacing the bulb/LED elements conductors accessible must not be exposed to humidity. Surfaces such as lampshades, glasses, reflectors and covers can be cleaned with a soft cloth but without using detergents.

Protection level IP 20. Protection is provided against rain. No indications are provided on the luminaire.

ATTENTION The product cannot be disposed as unsorted municipal waste. It must be collected separately to prevent negative environmental impacts. In accordance with the procedures of Directive 2012/19/UE and relevant national laws and regulations adopted pursuant to this Directive on the disposal of waste at the end of the life cycle of the product, any violation is sanctioned by law. Please inform yourself about the local separate collection system for electrical and electronic products.

Installation and maintenance must be performed exclusively by specialised personnel.

ATTENTION L'appareil ne doit pas être éliminé comme simple déchet urbain mais conformément à la Directive 2012/19/UE conformément à la Directive 2012/19/UE et aux dispositions légales qui s'appliquent pour ce qui touche à la durée de vie, les contrevenants aux dispositions en vigueur sont passibles des sanctions prévues par la loi. Veuillez vous informer du système local de séparation des déchets électriques et électroniques.

Essential insulation: the accessible conductive parts are connected to an earth conductor. Grounding is mandatory.

Remove the lamp plug from its socket or turn off the lamp supply circuit, and leave the bulb to cool.

Fitting and maintaining the unit and/or replacing the bulb/LED elements conductors accessible must not be exposed to humidity. Surfaces such as lampshades, glasses, reflectors and covers can be cleaned with a soft cloth but without using detergents.

Protection level IP 20. Protection is provided against rain. No indications are provided on the luminaire.

ATTENTION The product cannot be disposed as unsorted municipal waste. It must be collected separately to prevent negative environmental impacts. In accordance with the procedures of Directive 2012/19/UE and relevant national laws and regulations adopted pursuant to this Directive on the disposal of waste at the end of the life cycle of the product, any violation is sanctioned by law. Please inform yourself about the local separate collection system for electrical and electronic products.

Installation and maintenance must be performed exclusively by specialised personnel.

ATTENTION L'appareil ne doit pas être éliminé comme simple déchet urbain mais conformément à la Directive 2012/19/UE conformément à la Directive 2012/19/UE et aux dispositions légales qui s'appliquent pour ce qui touche à la durée de vie, les contrevenants aux dispositions en vigueur sont passibles des sanctions prévues par la loi. Veuillez vous informer du système local de séparation des déchets électriques et électroniques.

Essential insulation: the accessible conductive parts are connected to an earth conductor. Grounding is mandatory.

Remove the lamp plug from its socket or turn off the lamp supply circuit, and leave the bulb to cool.

Fitting and maintaining the unit and/or replacing the bulb/LED elements conductors accessible must not be exposed to humidity. Surfaces such as lampshades, glasses, reflectors and covers can be cleaned with a soft cloth but without using detergents.

Protection level IP 20. Protection is provided against rain. No indications are provided on the luminaire.

ATTENTION The product cannot be disposed as unsorted municipal waste. It must be collected separately to prevent negative environmental impacts. In accordance with the procedures of Directive 2012/19/UE and relevant national laws and regulations adopted pursuant to this Directive on the disposal of waste at the end of the life cycle of the product, any violation is sanctioned by law. Please inform yourself about the local separate collection system for electrical and electronic products.

Installation and maintenance must be performed exclusively by specialised personnel.

ATTENTION L'appareil ne doit pas être éliminé comme simple déchet urbain mais conformément à la Directive 2012/19/UE conformément à la Directive 2012/19/UE et aux dispositions légales qui s'appliquent pour ce qui touche à la durée de vie, les contrevenants aux dispositions en vigueur sont passibles des sanctions prévues par la loi. Veuillez vous informer du système local de séparation des déchets électriques et électroniques.

Essential insulation: the accessible conductive parts are connected to an earth conductor. Grounding is mandatory.

Remove the lamp plug from its socket or turn off the lamp supply circuit, and leave the bulb to cool.

Fitting and maintaining the unit and/or replacing the bulb/LED elements conductors accessible must not be exposed to humidity. Surfaces such as lampshades, glasses, reflectors and covers can be cleaned with a soft cloth but without using detergents.

Protection level IP 20. Protection is provided against rain. No indications are provided on the luminaire.

ATTENTION The product cannot be disposed as unsorted municipal waste. It must be collected separately to prevent negative environmental impacts. In accordance with the procedures of Directive 2012/19/UE and relevant national laws and regulations adopted pursuant to this Directive on the disposal of waste at the end of the life cycle of the product, any violation is sanctioned by law. Please inform yourself about the local separate collection system for electrical and electronic products.

Installation and maintenance must be performed exclusively by specialised personnel.

ATTENTION L'appareil ne doit pas être éliminé comme simple déchet urbain mais conformément à la Directive 2012/19/UE conformément à la Directive 2012/19/UE et aux dispositions légales qui s'appliquent pour ce qui touche à la durée de vie, les contrevenants aux dispositions en vigueur sont passibles des sanctions prévues par la loi. Veuillez vous informer du système local de séparation des déchets électriques et électroniques.

Essential insulation: the accessible conductive parts are connected to an earth conductor. Grounding is mandatory.

Remove the lamp plug from its socket or turn off the lamp supply circuit, and leave the bulb to cool.

Fitting and maintaining the unit and/or replacing the bulb/LED elements conductors accessible must not be exposed to humidity. Surfaces such as lampshades, glasses, reflectors and covers can be cleaned with a soft cloth but without using detergents.

Protection level IP 20. Protection is provided against rain. No indications are provided on the luminaire.

ATTENTION The product cannot be disposed as unsorted municipal waste. It must be collected separately to prevent negative environmental impacts. In accordance with the procedures of Directive 2012/19/UE and relevant national laws and regulations adopted pursuant to this Directive on the disposal of waste at the end of the life cycle of the product, any violation is sanctioned by law. Please inform yourself about the local separate collection system for electrical and electronic products.

Installation and maintenance must be performed exclusively by specialised personnel.

ATTENTION L'appareil ne doit pas être éliminé comme simple déchet urbain mais conformément à la Directive 2012/19/UE conformément à la Directive 2012/19/UE et aux dispositions légales qui s'appliquent pour ce qui touche à la durée de vie, les contrevenants aux dispositions en vigueur sont passibles des sanctions prévues par la loi. Veuillez vous informer du système local de séparation des déchets électriques et électroniques.

Essential insulation: the accessible conductive parts are connected to an earth conductor. Grounding is mandatory.

Remove the lamp plug from its socket or turn off the lamp supply circuit, and leave the bulb to cool.

Fitting and maintaining the unit and/or replacing the bulb/LED elements conductors accessible must not be exposed to humidity. Surfaces such as lampshades, glasses, reflectors and covers can be cleaned with a soft cloth but without using detergents.

Protection level IP 20. Protection is provided against rain. No indications are provided on the luminaire.

ATTENTION The product cannot be disposed as unsorted municipal waste. It must be collected separately to prevent negative environmental impacts. In accordance with the procedures of Directive 2012/19/UE and relevant national laws and regulations adopted pursuant to this Directive on the disposal of waste at the end of the life cycle of the product, any violation is sanctioned by law. Please inform yourself about the local separate collection system for electrical and electronic products.

Installation and maintenance must be performed exclusively by specialised personnel.

ATTENTION L'appareil ne doit pas être éliminé comme simple déchet urbain mais conformément à la Directive 2012/19/UE conformément à la Directive 2012/19/UE et aux dispositions légales qui s'appliquent pour ce qui touche à la durée de vie, les contrevenants aux dispositions en vigueur sont passibles des sanctions prévues par la loi. Veuillez vous informer du système local de séparation des déchets électriques et électroniques.

Essential insulation: the accessible conductive parts are connected to an earth conductor. Grounding is mandatory.

Remove the lamp plug from its socket or turn off the lamp supply circuit, and leave the bulb to cool.

Fitting and maintaining the unit and/or replacing the bulb/LED elements conductors accessible must not be exposed to humidity. Surfaces such as lampshades, glasses, reflectors and covers can be cleaned with a soft cloth but without using detergents.

Protection level IP 20. Protection is provided against rain. No indications are provided on the luminaire.

ATTENTION The product cannot be disposed as unsorted municipal waste. It must be collected separately to prevent negative environmental impacts. In accordance with the procedures of Directive 2012/19/UE and relevant national laws and regulations adopted pursuant to this Directive on the disposal of waste at the end of the life cycle of the product, any violation is sanctioned by law. Please inform yourself about the local separate collection system for electrical and electronic products.

Installation and maintenance must be performed exclusively by specialised personnel.

ATTENTION L'appareil ne doit pas être éliminé comme simple déchet urbain mais conformément à la Directive 2012/19/UE conformément à la Directive 2012/19/UE et aux dispositions légales qui s'appliquent pour ce qui touche à la durée de vie, les contrevenants aux dispositions en vigueur sont passibles des sanctions prévues par la loi. Veuillez vous informer du système local de séparation des déchets électriques et électroniques.

Essential insulation: the accessible conductive parts are connected to an earth conductor. Grounding is mandatory.

Remove the lamp plug from its socket or turn off the lamp supply circuit, and leave the bulb to cool.

Fitting and maintaining the unit and/or replacing the bulb/LED elements conductors accessible must not be exposed to humidity. Surfaces such as lampshades, glasses, reflectors and covers can be cleaned with a soft cloth but without using detergents.

Protection level IP 20. Protection is provided against rain. No indications are provided on the luminaire.

ATTENTION The product cannot be disposed as unsorted municipal waste. It must be collected separately to prevent negative environmental impacts. In accordance with the procedures of Directive 2012/19/UE and relevant national laws and regulations adopted pursuant to this Directive on the disposal of waste at the end of the life cycle of the product, any violation is sanctioned by law. Please inform yourself about the local separate collection system for electrical and electronic products.

Installation and maintenance must be performed exclusively by specialised personnel.

ATTENTION L'appareil ne doit pas être éliminé comme simple déchet urbain mais conformément à la Directive 2012/19/UE conformément à la Directive 2012/19/UE et aux dispositions légales qui s'appliquent pour ce qui touche à la durée de vie, les contrevenants aux dispositions en vigueur sont passibles des sanctions prévues par la loi. Veuillez vous informer du système local de séparation des déchets électriques et électroniques.

IT

Istruzioni di montaggio e uso

EN

Assembly and operating Instructions

FR

Manuel de montage et mode d'emploi

DE

Montageanleitung und Gebrauchsanweisung

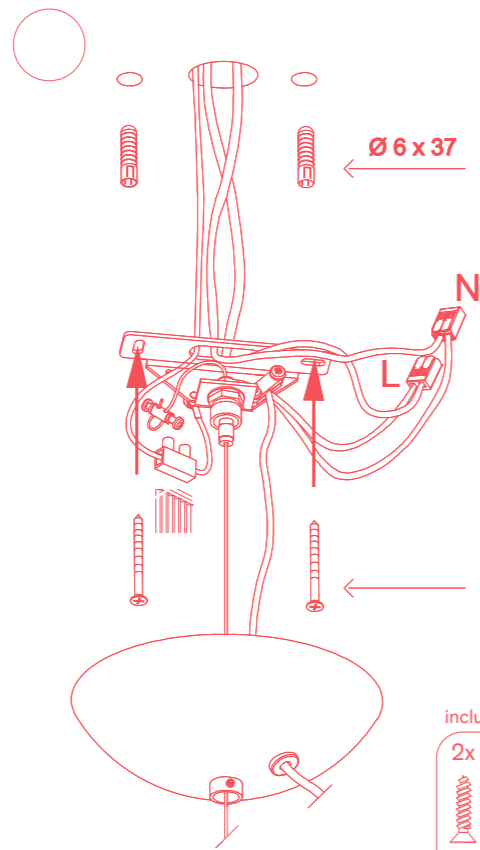
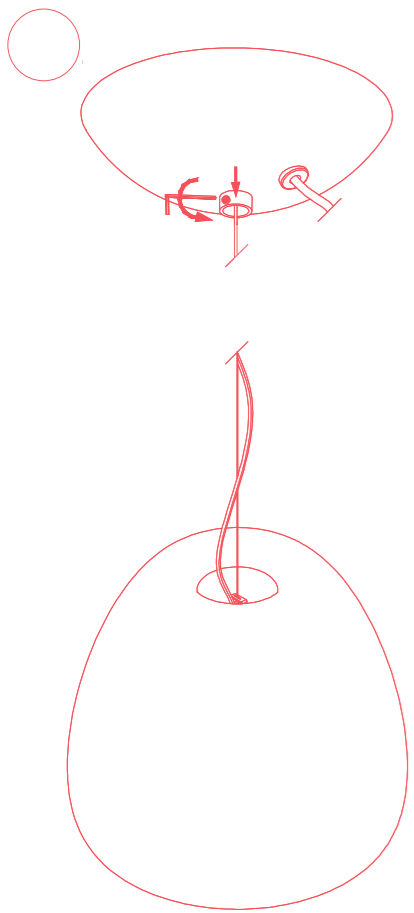

incluso/included

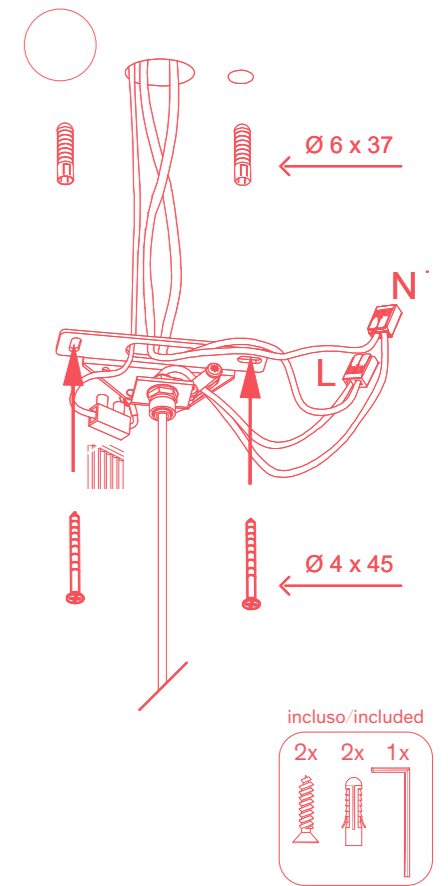
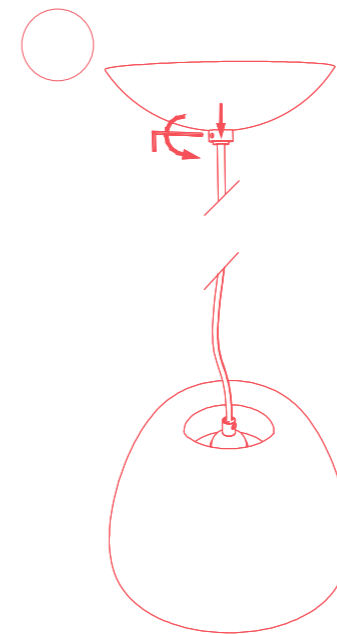
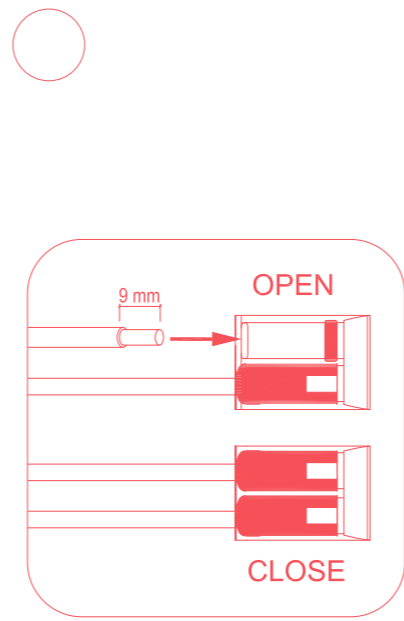
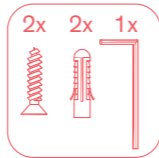

incluso/included

