

Cord and Plug

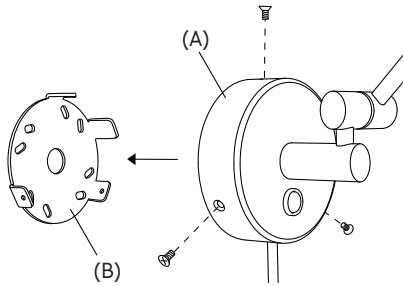

1. Remove the wall mounting (B) by unscrewing three screws from the lamp body (A).

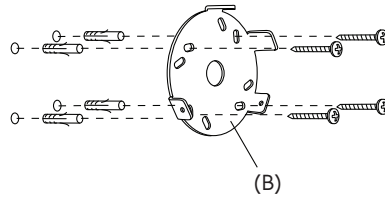

2. Mount the wall mounting to the wall with four appropriate screws and plugs. Always use correct screws and plugs for the mounting surface.

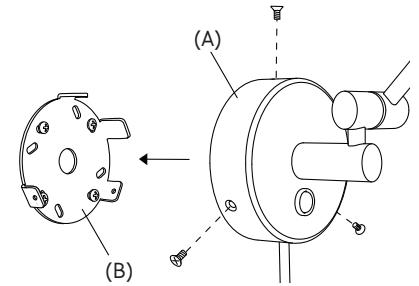

3. Attach the lamp body back to the wall mounting.

Direct Wall Mounting

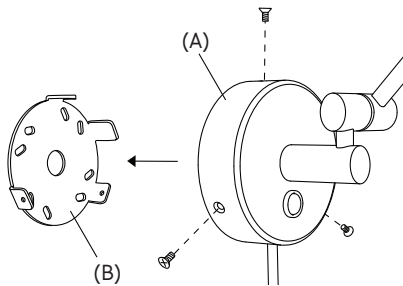

1. Remove the wall mounting (B) by unscrewing three screws from the lamp body (A).

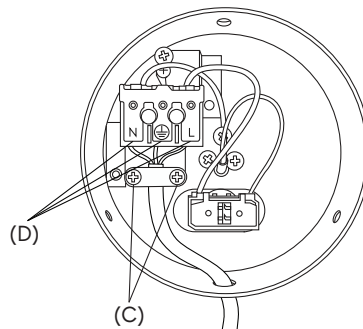

2. Unscrew the two screws (C) from the back of the lamp housing. Press N, ⊕, L tabs (D) on terminal strip to pull the cord out.

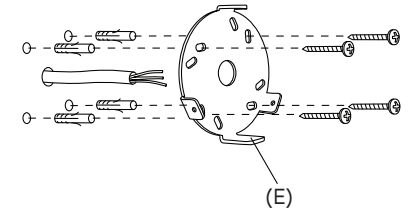

3. Position the wall mounting making sure the metal handle (E) is covering the hole on the lamp body. Mount it with four appropriate screws and plugs. Always use correct screws and plugs for the mounting surface.

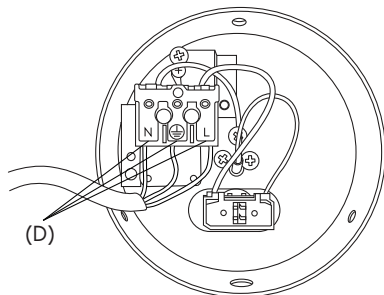

4. Connect the electrical cord with the terminal strip.

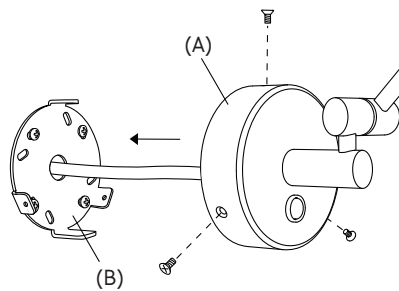

5. Attach the lamp body back to the wall mounting.

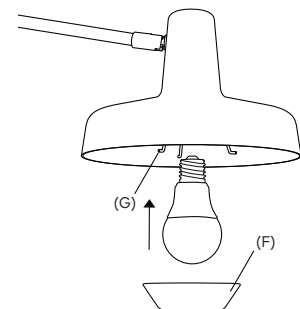

6. To insert the light bulb, release the undershade (F) by pressing three undershade brackets (G) inwards.

Arigato by GRUPA

Important

The safety of this product can only be guaranteed if these instructions are observed, during both installation and use. We advise keeping these instructions.

If the product requires installation, it should be performed by a qualified electrician.

This luminaire must be connected to a grounding electrical system. Always turn off power to the system before starting installation work. Whenever acting on the luminaire (i.e. changing the light bulb), ensure that the power supply has been switched off.

Different materials require different types of fittings. Always choose screws and plugs that are best suited for the material on which you are installing the luminaire.

Warning

This product has been carefully handmade and due to the nature of such work please allow slight variations in the surface of the material.

Do not use force to assemble the luminaire.

Do not over-tighten the components when assembling.

This product is for indoor use only. Do not immerse this product into water.

The light bulb is not included.

Never touch the light bulb when the luminaire is turned on, or shortly after it is turned off, because it can be hot and can cause burns. Do not touch the inner surfaces of the luminaire that may be hot.

Always pay attention to the luminaire balance, do not place or install the luminaire on uneven surfaces.

Regularly check that there is no damage to cables and other parts.

If the external cable of this luminaire is damaged, it must be exclusively replaced by the manufacturer or its authorized service agent or similar qualified persons in order to avoid a hazard.

Do not disassemble this product.

Grupa declines all responsibility for products that are modified without prior authorization.

Environment

Do not throw this product in regular household trash but in a proper waste disposal that is suitable for similar electrical appliances.

Cleaning

Powder-coated surfaces should be cleaned with aqueous solutions made from pH-neutral detergents or cleaning products and soft, non-abrasive cloths, rags or industrial cotton batting.

Always clean metal surfaces gently and without scrubbing so that the surface is not scratched. Never use cleaners containing granular substances, acetic acid or citric acid.

Manufacturer:
Grupa Studio d.o.o.
Popa Dukljanina 1
10000 Zagreb, Croatia, EU

info@grupa.com
grupa.com

220-230V, Max 70 Watt, E27

