

## 9628153

24,5W LED / 27W Total  
incl. LED Board: L9002481  
220-240V ~ 50/60Hz

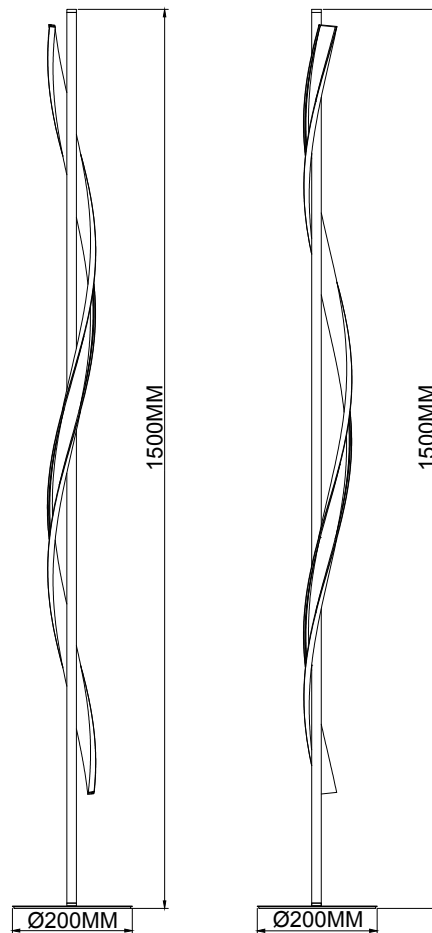



### (DE) Bestimmungsgemäße Verwendung

(EN) Intended use | (FR) Utilisation conforme | (NL) Beoogd gebruik | (PL) Stosowanie zgodnie z przeznaczeniem | (NO) Riktig bruk | (DK) Korrekt brug  
(SE) Avsedd användning | (FI) Määräystenmukainen käyttö | (IT) Impiego appropriato | (ES) Uso prescrito | (CZ) Použití v souladu s určením  
(PT) Utilização correta | (GR) Ενδεδειγμένη χρήση | (SK) Predpokladané použitie | (EE) Eeldatav kasutus | (LV) Paredzams lietojums  
(LT) Numatomas naudojimas | (RO) Utilizare intenționată | (SI) Predvidena uporaba | (HR) Namjenska upotreba | (HU) Tervezett felhasználás  
(BG) предназначена употреба | (AL) Përdorimi i parashikuar | (MK) Предвидена употреба | (TR) Amaçlı kullanım | (UK) Призначене використання  
(BA,ME,RS) Namjenska upotreba

(DE)	Als Stehleuchte im Innenbereich	(GB)	Use as a floor lamp indoors
(FR)	En tant que lampadaire sur des sols plats, stables, à l'intérieur	(NL)	Binnenshuis als staande lamp op effen ondergrond
(PL)	Jako lampa stojąca na równych, stabilnych podłogach we wnętrzach	(NO)	Som gulvlampe på rett flate innendørs
(DK)	Som gulvlampe på ret gulv indendørs	(SE)	Används som golvlampa inomhus
(FI)	Käyttö sisätilojen lattialavalaisimena	(IT)	Impiego come lampada da pavimento in ambienti interni
(ES)	Empleo en tanto lámpara de pie en interiores	(CZ)	Použití jako stojací lampa v interiéru
(PT)	Aplicação como candeeiro de pé em interiores	(GR)	Χρήση ως επιδαπέδιο φωτιστικό σε εσωτερικό χώρο
(SK)	Použite ako podlahovú lampu v interiéri	(BG)	Използвайте като подова лампа в помещението
(EE)	Kasutage põrandalampina siseruumides	(LV)	Izmantojiet kā grīdas lampu telpās
(LT)	Naudokite kaip grindų lempas viduje	(RO)	Utilizați ca o lampă de podea în interior
(SI)	Uporabite kot talna svetilka v notranjosti	(HR)	Koristite kao podnu lampu unutar
(HU)	Használja padlólámpaként beltérben	(AL)	Përdor si një llambë dysheme brenda
(MK)	Користете го како ламба за под внатре	(TR)	İç mekanda bir zemin lambası olarak kullanın
(UK)	Використовуйте як підлогову лампу всередині приміщення	(BA)	Koristite kao podnu lampu unutar
		(ME)	
		(RS)	

(DE) Lieferumfang		
(EN) Package contents   (FR) Contenu de la livraison   (NL) Bij de levering inbegrepen   (PL) Zakres dostawy   (NO) Levering   (DK) Leveringsomfang (SE) Leveransomfattning   (FI) Toimitussisältö   (IT) Fornitura   (ES) Volumen de suministro   (CZ) Rozsah dodávky   (PT) Material fornecido (GR) Παραδοτέος εξοπλισμός   (SK) Obsah balenia   (EE) Pakendi sisu   (LV) Pakas saturs   (LT) Pakuotės turinys (RO) Conținutul pachetului   (SI) Vsebina paketa   (HR) Sadržaj paketa   (HU) A csomag tartalma   (BG) обхват на доставката (AL) Përmbajtja e dorëzimit   (MK) Содржина на испорака   (TR) Teslimat içeriği   (UK) Зміст доставки   (BA,ME,RS) Sadržaj isporuke		
(DE) 1 Stehleuchte Montagematerial Montageanleitung	(GB) 1 Floor lamp Installation hardware Mounting instructions	(FR) 1 Lampadaire Matériel de montage Instructions de montage
(NL) 1 Vloerlamp Monteringsmateriale Montagehandleiding	(PL) 1 Lampa stojąca Elementy montażowe Instrukcja montażu	(NO) 1 Gulvlampe Monteringsmateriale Brukerveiledning
(DK) 1 Gulvlampe Monteringsmateriale Brugervejledning	(SE) 1 Golvlampa Monteringsmaterial Monteringsanvisning	(FI) 1 Lattiavalaisin Asennusmateriaali Asennusohjeet
(IT) 1 Lampada da pavimento Materiale di montaggio Istruzioni di montaggio	(ES) 1 Lámpara de pie Material de montaje Instrucciones de montaje	(CZ) 1 Stožací lampa Materiál pro montáž Návod k montáži
(PT) 1 Candeeiro de pé Material de montagem Instruções de montagem	(GR) 1 Επιδαπέδιο φωτιστικό Υλικό συναρμολόγησης Οδηγίες συναρμολόγησης	(SK) 1 Podlahová lampa Inštalačný hardvér Inštalačná príručka
(BG) 1 Подова лампа материали за монтаж инструкции за монтаж	(EE) 1 Põrandalamp Paigaldustarvikud Paigaldusjuhend	(LV) 1 Grīdas lampa Instalācijas aparatūra Uzstādīšanas instrukcija
(LT) 1 Grindų lempa Montavimo aparatinė įranga Montavimo instrukcija	(RO) 1 Lampă de podea Hardware de instalare Instrucțiuni de montare	(SI) 1 Talna svetilka Namestitvena strojna oprema Navodila za montažo
(HR) 1 Podna lampa Instalacijski hardver Upute za montažu	(HU) 1 Padlólámpa Telepítési hardver Szerelési útmutató	(AL) 1 Lampa kate Materiali i montimit Udhëzuesi i montimit
(MK) 1 Светилка за под Монтажен материјал Упатство за монтажа	(TR) 1 Yer lambası Montaj malzemesi Montaj kılavuzu	(UK) 1 Підлогова лампа Монтажний матеріал Інструкція з монтажу
(BA) 1 Podna lampa (ME) Montažni materijal (RS) Uputstvo za montažu		

(DE) Verwendete Symbole	
(EN) Safety Precautions   (FR) Symboles utilisés   (NL) Gebruikte symbolen   (PL) Stosowane symbole   (NO) Brukte symboler   (DK) Brugte symboler (SE) Använda symboler   (FI) Käytetyt symbolit   (IT) Simboli usati   (ES) Símbolos empleados   (CZ) Použité symboly   (PT) Símbolos utilizados (GR) Χρησιμοποιούμενα σύμβολα   (SK) Bezpečnostné opatrenia   (EE) Ohutusabinõud   (LV) Drošības pasākumi (LT) Saugos priemonės   (RO) Măsuri de precauție   (SI) Varnostni ukrepi   (HR) Mjere opreza   (HU) Használt szimbólumok   (BG) Мерки за безопасност (AL) Simbolet e përdorura   (MK) Користени симболи   (TR) Kullanılan semboller   (UK) Використовувані символи   (BA,ME,RS) Korišteni simboli	
IP 20	  

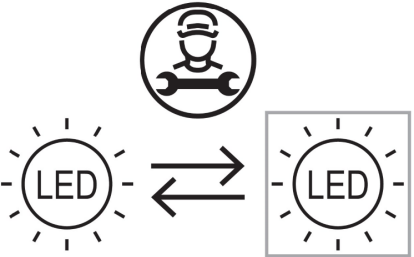

<p>(DE) Dieses Produkt enthält eine Lichtquelle der Energieeffizienzklasse F          (EN) This product contains a light source of energy efficiency class F          (FR) Ce produit comprend une source de lumière de classe d'efficience énergétique F          (NL) Dit product bevat een lichtbron van energie-efficiëntieklasse F          (PL) Produkt ten zawiera źródło światła o klasie efektywności energetycznej F          (NO) Dette produktet inneholder en lyskilde i energieeffektivitetsklasse F          (DK) Dette produkt indeholder en lyskilde af energieeffektklasse F          (SE) Denna produkt innehåller en ljuskälla i energieffektivitetsklass F          (FI) Tämä tuote sisältää energiatehokkuusluokan F valonlähteen          (IT) Questo prodotto contiene una sorgente luminosa della classe di efficienza energetica F          (ES) Este producto contiene una fuente de luz de la clase de eficiencia energética F          (CZ) Tento výrobek obsahuje světelný zdroj třídy energetické účinnosti F          (PT) Este produto contém uma fonte de luz da classe de eficiência energética F          (GR) Αυτό το προϊόν περιέχει μια φωτεινή πηγή ενεργειακής απόδοσης κλάσης F          (SK) Tento výrobok obsahuje zdroj svetla triedy energetickej efektivity F          (EE) See toode sisaldab energiatõhususklassi F valgusallikat          (LV) Šis produkts satur enerģijas efektivitātes klases F gaismas avotu          (LT) Šis gaminys turi energijos efektyvumo klasės F šviesos šaltinį          (RO) Acest produs conține o sursă de lumină de clasă de eficiență energetică F          (SI) Ta izdelek vsebuje svetlobni vir energijskega razreda F          (HR) Ovaj proizvod sadrži izvor svjetlosti energetske učinkovitosti klase F          (HU) Ez a termék egy F energiahatékonysági osztályú fényforrást tartalmaz          (BG) Този продукт съдържа източник на светлина с клас на енергийна ефективност: F          (AL) Ky produkt përmban një burim drite të klasës së efikasitetit të energjisë F          (MK) Ovoj proizvod sadrži izvor na svetlina od klasa na energetska efikasnost F          (TR) Bu ürün, enerji verimliliği sınıfı F olan bir ışık kaynağı içerir          (UK) Цей продукт містить джерело світла класу енергоефективності F          (BA)(ME)(RS) Ovaj proizvod sadrži izvor svjetlosti energetske klase F</p>	<p>QR</p> 	<p>EAN</p> <p>4251911755831</p>
--	---	---------------------------------

	<p>(DE) Durch einen Fachmann austauschbare Lichtquelle (nur LED).          (EN) Replaceable (LED only) light source by a professional.          (FR) Source de lumière remplaçable (LED uniquement) par un professionnel.          (NL) Lichtbron (alleen led) te vervangen door een professional.          (PL) Wymienne (tylko LED) źródło światła wykonane przez profesjonalistę.          (NO) Utskiftbar (kun LED) lyskilde av en profesjonell.          (DK) Udskiftelig lyskilde (kun LED), udskiftes af en elektriker.          (SE) Ljuskälla (endast LED) utbytbar genom fackman.          (FI) Ammatillainen voi vaihtaa vaihdettavan (vain LED) valonlähteen.          (IT) Sorgente luminosa (solo LED) sostituibile da un professionista.          (ES) Fuente de luz (solo LED) sustituible por un profesional.          (CZ) Vyměnitelný (pouze LED) světelný zdroj odborníkem.          (PT) Luz LED (apenas LED) substituível por um profissional.          (GR) Η πηγή φωτός (μόνο LED) να αντικαθίσταται από επαγγελματία.          (SK) Zdroj svetla (iba LED) vymeniteľný prostredníctvom odborníka.          (EE) Spetsialisti poolt vahetatav valgusallikas (ainult LED).          (LV) Speciālista maināms gaismas avots (tikai LED).          (LT) Specialisto keičiamas šviesos šaltinis (tik LED).          (RO) Sursă de lumină schimbabilă de către un specialist (doar LED).          (SI) Svetlobni vir, ki ga lahko zamenja strokovnjak (samo LED).          (HR) Izvor svjetlosti koji može zamijeniti stručnjak (samo LED).          (HU) Szakember által cserélhető (csak LED) fényforrás.          (BG) Светлинен източник, който може да се смени от специалист (само LED).          (AL) Burim drite i zëvendësueshëm (LED vetëm) nga një profesionist.          (MK) Изворот на светлина (само LED) се заменува од професионалец.          (TR) Değiştirilebilir (yalnızca LED) ışık kaynağı bir profesyonel tarafından değiştirilir.          (UK) Замінний (тільки LED) джерело світла замінюється фахівцем.          (BA)(ME)(RS) Zamjenjiv (samo LED) izvor svjetlosti zamjenjuje profesionalac.</p>
---	--

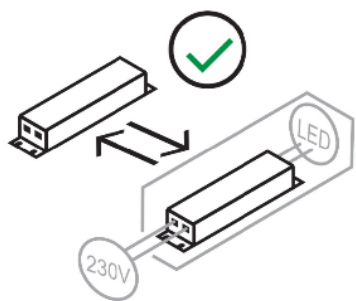

- (DE) Durch einen Endverbraucher austauschbares Betriebsgerät.  
 (EN) Replaceable control gear by an end-user.  
 (FR) Contrôleur remplaçable (LED uniquement) par le consommateur.  
 (NL) Voorschakelapparatuur te vervangen door consument.  
 (PL) Wymienny osprzęt sterujący przez użytkownika końcowego.  
 (NO) Utskiftbar kontrollutstyr av en sluttbruker.  
 (DK) Udskiftelig igangsætter, kan udskiftes af slutbrugeren.  
 (SE) Styrdon utbytbart genom slutkonsument.  
 (FI) Loppukäyttäjän vaihdettavat ohjauslaitteet.  
 (IT) Dispositivo di controllo sostituibile da un utente finale.  
 (ES) Dispositivo de control sustituible por un usuario final.  
 (CZ) Výměnitelný předřadník koncovým uživatelem.  
 (PT) Dispositivo de controlo substituível por um utilizador final.  
 (GR) Ο εξοπλισμός ελέγχου να αντικαθίσταται από τον τελικό χρήστη.  
 (SK) Predradník vymeniteľný prostredníctvom koncového používateľa.  
 (EE) Asendatav juhtseade lõppkasutaja poolt.  
 (LV) Aizstājams vadības aprīkojums lietotāja puse.  
 (LT) Keičiamas valdymo įrenginys naudotojo.  
 (RO) Echipament de comandă înlocuibil de către utilizatorul final.  
 (SI) Zamenljiva krmilna oprema s strani končnega uporabnika.  
 (HR) Zamjenjiva upravljačka oprema od strane krajnjeg korisnika.  
 (HU) Cserélhető vezérlőberendezés a végfelhasználó által.  
 (BG) Заменяемо управляващо оборудване от крайния потребител.  
 (AL) Pajisje kontrolli e zëvendësueshme nga përdoruesi përfundimtar.  
 (MK) Заменлива контролна опрема од корисникот.  
 (TR) Son kullanıcı tarafından değiştirilebilir kontrol donanımı.  
 (UK) Замінний керуючий пристрій від кінцевого користувача.  
 (BA)(ME)(RS) Zamjenjiva kontrolna oprema od strane krajnjeg korisnika.